

Service
Service
Service



Philips Domestic Appliances and Personal Care

Service Manual

PRODUCT INFORMATION

- This product meets the requirements regarding interference suppression on radio and TV.
- After the product has been repaired, it should function properly and has to meet the safety requirements as officially laid down at this moment.

TECHNICAL INFORMATION

- Power : 70 W
- Power consumption :
 - Cool down period average (KEG 23 °C -> 3 °C) : 0.062 kWh
 - Standby period (KEG on 3 °C) : 0.042 kWh
- Voltage : 100 - 120 V - 50/60 Hz
200 - 240 V - 50/60 Hz
- Flow rate : 2 L per minute
- Contents Keg : 6 L
- Colour setting : Black/Metal
- SAP coding : HD3620/20

OPTIONAL (accessories)

- No specific issues

For your safety first be sure the plug is disconnected from the mains!

Removing the back cover:

- To remove the back cover, first remove the 4 screws.
- Open both doors, at the upper/lower right and left side the screws can be found.

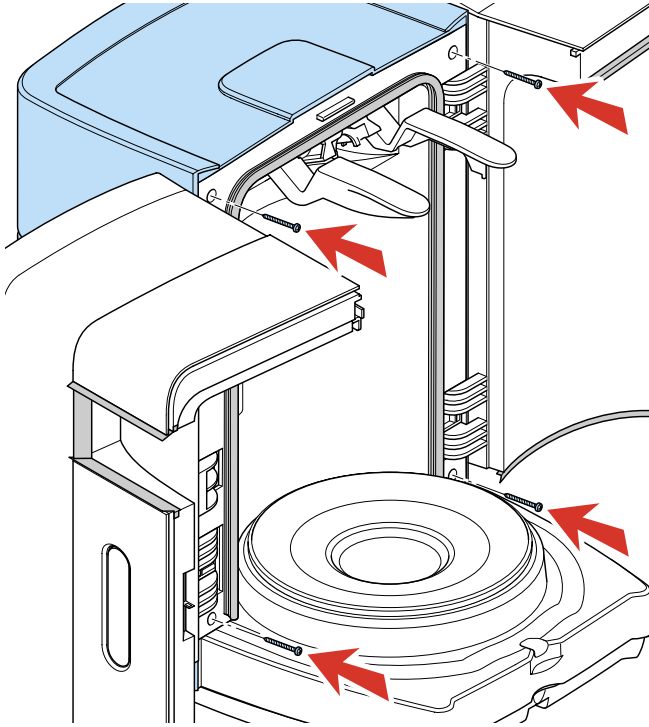

Picture 1.

- When the back cover has been removed all parts can easy be reached.

Replacing the Lever Connector Assembly:

- Remove the screw that you can see on the front.
- Remove the hose from the pump unit.
- Now the lever assembly can be removed from the appliance.
- Reassembling follow above steps in reverse order.

Replacing the Display:

- When the display has to be replaced for some reason, the complete Left door including display and flat cable has to be replaced.
- Remove the back cover.
- Disconnect the flat cable connector from the main PCB that is coming from the right door.
- Unscrew the two screws that are holding the door.
- To re-assembly carry out steps backwards.

Replacing the Fan assy.

- When the Fan has to be replaced, unscrew the 4 posi screws and disconnect the connector of the Fan.
- When re-assemble the fan assy, be sure that the airflow (see arrow on the Fan) is appointing to the heat sink.

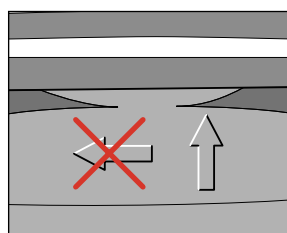

Picture 2.

*** Note: When the Fan became defect also Peltier element has to be replaced or fully checked on performance.**

Due to overheating also the Peltier element will be damaged.

Replacing the Peltier element:

- When the Peltier element has to be replaced, first remove the back cover and Fan assy.
- Unscrew the 2 screws located on the heat sink.
- The heat sink including Peltier element can now be removed.
- With a small screwdriver the Peltier element can be removed from the heat sink, some force maybe needed.
- Before placing the new Peltier element, clean the chiller plate and heat sink thoroughly.

- Provide heat sink paste on the heat sink and chiller plate. With a plastic comb (or plastic like a credit card) carefully provide the heat sink paste as equable as possible.
- Place the new Peltier element on the chiller plate at the same position of the removed Peltier element.

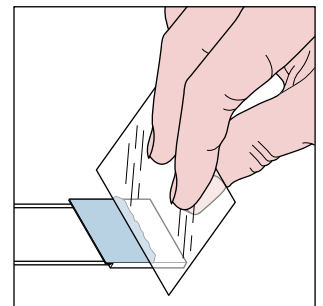

Picture 3.

NOTE! It is important to place the Peltier element with the right side on the chiller plate. (see picture 4 for details)

- In other words, the cooling side of the Peltier has to point to the chillerplate and the warm side has to point to the heat sink.
- Detail to check is the Colour of the wires must be equal positioned see, picture 4 for detail.

- Make sure the Peltier element is well placed.
- Place the heat sink.
- Hold and place the heat sink with force against the Peltier element.
- Tighten the screws alternate, to prevent damaging the Peltier element for mounting lop-sided.
- While screwing wait some seconds so that the heat sink past can be settled between the surfaces.
- **Maximum force that maybe applied to tighten the screws are: 0.6 Nm.**

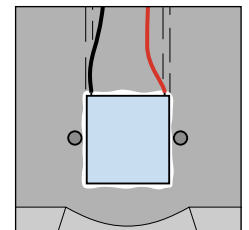

Picture 4.

Replacing the pump unit:

- Start with disconnecting the air pressure hose and electrical connections.
- Unscrew the 3 screws from the plastic pump bracket.
- To re-assembly carry out steps backwards.

NOTE! To prevent leakage at the connection side of the hose, cut a small piece off the end of the hose.

Electrical circuit:

- When the appliance does not work, check the electrical circuit.

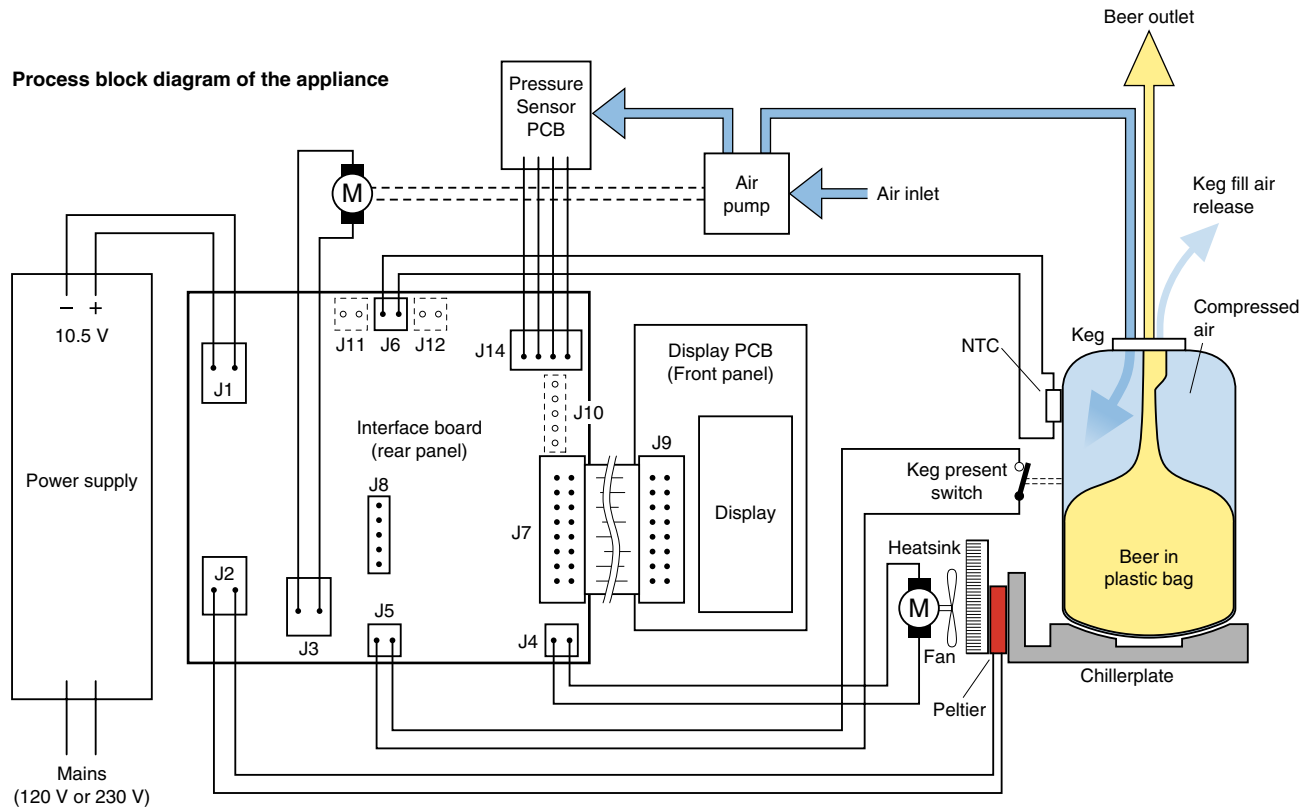

Picture 5.

Working principle of the appliance

- Hereby a short description of the working principle.
- Beer, the Beer is stored in a plastic bag inside the Keg, see picture 5.
- The Beer only comes in contact with the tube connector and never with the appliance.
- When the tap unit and tube connector are connected on the Keg and the Keg is placed in the appliance, the Keg present switch will be activated.
- Once the appliance is activated after approximately 10 seconds you will hear a pump running.
- The task of this pump is to fill the space between the plastic bag and the walls of the Keg with air and create an overpressure (± 1500 mBar).
- Through the over pressure around the plastic bag (comparable like you squeeze into the plastic bag) the Beer will be pressurized (sort of) as well.
- By pulling the tap handle the tube connector hose will become opened and the Beer will flow out of the plastic bag via the tube connector in to the glass.
- After this cycle the pump will start running to get back in the overpressure situation like described before.
- When the Keg present switch has been actuated also the cooling process (Peltier element) will be started and display functions become visible.
- The temperature is measured by a NTC located near the Keg present plunger.
- The volume indication is based on the principle of a pressure drop measured by the pressure sensor. The speed and value of the pressure drop will be calculated in an algorithm, the outcome will be represented as volume on the display.
- When pouring Beer, the pressure in the KEG will decrease, the amount the pressure decrease in a period of time will be calculated through the system and indicated as volume on the display.
- The volume indication is divided in 9 steps.
- The Beer Freshness indicator is a day counter (24 h) and can be adjusted with the + and - button. (default 30days)

Service test routines

- This appliance has been equipped with special service routines to be able to check several functions of the appliance.
- Below the necessary steps will be described to enter into the service mode.
- Please follow the instructions carefully to avoid damaging the electronic circuit of the appliance.

Read out the software version of the appliance.

1. Disconnect the appliance from mains.
2. Keep the + button at the display pressed and connect appliance to the mains.
3. Keep the + button pressed and readout the software version (number indicated for example 21 = version 2.1), see example.
4. When the + button is released the appliance returns to the normal state.

**Putting the appliance into Display test mode.**

1. Disconnect the appliance from mains.
2. Keep the + and - button at the display pressed and connect appliance to the mains.
3. The display test starts. (countdown temperature indication from 20 to 3 then volume bars will be decreased one by one and after that the freshness day counter will be counting down from 30 to 0.
4. This process will continue over and over again until the appliance will be unplugged!
See examples.

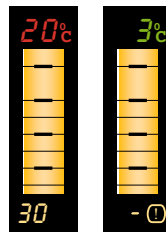

Normal VolDisp
 Green segment if TempDisp < 5 °C
 Red segment if TempDisp ≥ 5 °C
 Normal FreshDisp

- Above 2 routines can be used to check the software version and working of the Display.
- If internal parts like NTC/Pump, Peltier or FAN must be checked also the service test routines, see further can be carried out.

Putting the appliance into Service test mode.



1. Disconnect the appliance from mains.
2. Remove the KEG (if placed)
3. Keep the KEG present switch pressed and connect the appliance to the mains.
4. When the display comes up release the KEG present switch. (if the KEG present switch will be released within 2 sec after powering up the service mode is entered.
5. If above steps succeeded the appliance will show the current software version.

Stepping through the Service mode.

- Now the service mode is entered it is possible by pressing and releasing the KEG present switch to step through the service routines.
- The list below shows all the possible Service Modes.
- After step mode 10, the routine jumps back to step mode 0.
- Exit the routine by unplugging the appliance.

Note:

For step mode 4 - 5 the KEG present switch must kept pressed other wise the Fan will not work!

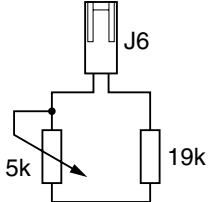
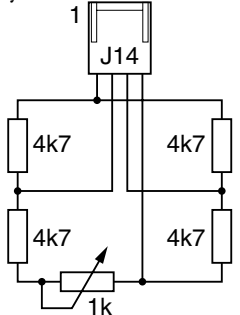
Stepmode (Press & release KEG switch)	Test	Stimulus	Response	Remark
0	Show software version		 Shows software version	2 digits. E.g. 21 = version 2.1
1	Display test		 All segments are lit	
2	Temperature test Disconnect NTC (J6) from the PCB. Apply to (J6) below resistance values.	NTC simulated value 1. 1 kΩ (1%) 2. 10 kΩ (1%) 3. 51 kΩ (1%) 4. out of range	Display indicates: 1. 1≅C (red color) 2. 2≅C (green) 3. 3≅C (red) 4. - (red)	Replace NTC sensor by dummy sensor. 
3	Pressure measurement Disconnect Pressure sensor (J14) Connect external dummy.	Pressure simulated value (mV) 1. 0 - 2mV 2. 4 - 6mV 3. 8 - 10mV 4. out of range	Freshness indicates: 1. 1 (yellow) 2. 2 (yellow) 3. 3 (yellow) 4. - (yellow)	* Replace pressure sensor and apply dummy.  * Depending on the possibilities either dummy or pressure can be applied for testing.
	Apply to the air inlet of the sensor or air coupling the following pressures.	Pressure simulated value (mBar) 1. 0 - 300 2. 600 - 900 3. 1200 - 1500 4. out of range	1. 1 (yellow) 2. 2 (yellow) 3. 3 (yellow) 4. - (yellow)	* Apply calibrated air pressure to the Pressure sensor or by the Air coupling hole. * Depending on the possibilities either voltage or pressure can be applied for testing.
4	Fan motor low level		1. Fan starts running. 2. Display Off.	Keep KEG switch pressed!! Fan runs on (80%) level Voltage across fan: ~7 - 8.5 Vdc / ~0.25 Vrms
5	Fan motor high level		1. Fan starts running. 2. Display Off.	Keep KEG switch pressed!! Fan runs on (100%) high level Voltage across fan: ~10.5 Vdc / ~0 Vrms

Stepmode (Press & release KEG switch)	Test	Stimulus	Response	Remark
6	Peltier medium		1. Peltier starts cooling. 2. Display Off.	Peltier runs on medium level (~50%) Voltage across Peltier: ~6.0 Vdc / ~4.0 Vrms Current through Peltier: ~4 A rms
8	Peltier high		1. Peltier starts cooling. 2. Display Off.	Peltier runs on high level (100%) Voltage across Peltier: ~10.5 Vdc / ~0.0 V rms Current through Peltier: >4.7A rms (lower=defect Peltier)
9	Pump test		1. Pump starts. 2. Display Off.	
10	Freshness indicator and + & - button test	With the + & - buttons in the display the Freshness day counter can be changed. (30 - 1)		

Procedure for checking cool down performance Peltier element.

- To ensure the Cool performance of the Peltier element is according specification the below test procedure have to be carried out.

Preparations:

1. Switch the appliance off and let it stabilize until it reached room temperature.
2. Remove under the base in the middle the rubber cap.
3. Remove the isolation foam under the removed cap, until the chiller plate becomes visible.

- Perform the temperature measurement, when the unit has reached the room/environment temperature.

1. Place a contact temperature probe against the chiller plate were the cap was removed.
2. Block the air inlet coupling at the Keg side, see picture 6 for location.

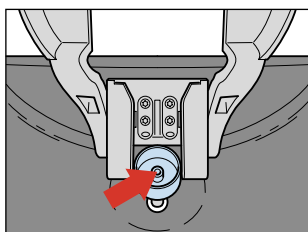

Picture 6.

3. Plug the appliance in the wall socket and bridge over the Keg present mechanically or electrically so the appliance will start.
4. When the appliance has started the pump will run shortly (in case the air inlet has been blocked properly)
5. Readout the temperature meter and note it down.
6. Keep the appliance switched on for 2 minutes, readout the temperature again.
7. If the temperature has **decreased** more then 6 °C, between the two measurements the cooling performance is OK, if not please check again or replace peltier or Fan assy.

Final:

- When the appliance is checked and OK, fill the hole under the cap again with foam or other isolation material and place the cap back under the base.

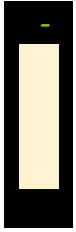
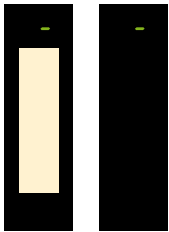
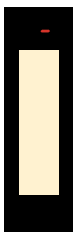
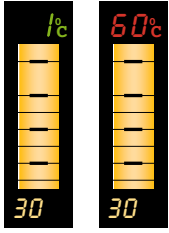
	Problem	Cause	Repair solution	
1	Appliance doesn't work.	1. Power supply failed. 2. Keg present switch failed.	1. Check voltage output 10 V ± 0.5 V. (replace power supply) 2. Check/replace micro switch.	
2	DISPLAY ERROR SIGNALS		DISPLAY no tap unit. Software detection: When the system detects no pressure rise during running of the pump (duration measurement 10 seconds), the software will interpret that there is no tap unit placed. Checks: <ul style="list-style-type: none"> • Place tap unit. • Is the pressure sensor function correctly? • Is air leakage noticeable in the system? 	
			DISPLAY leakage. Blinking faded background of VolDisp or No FreshDisp. Green segment if TempDisp < 5° C. Red segment if TempDisp ≥ 5° C.	Software detection: The system detects a pressure fall that is greater than normal when pouring Beer, the software will interpret that there is a leakage in the system. Measurement takes approximately 300 seconds. Checks: <ul style="list-style-type: none"> • Is the pressure sensor function correctly? • Is air leakage noticeable in the system?
			DISPLAY no KEG /standby. Faded background of VolDisp. Red segment. No FreshDisp.	Software detection: The KEG present/activation switch will give input to the Interface board. Checks: <ul style="list-style-type: none"> • Is the micro switch function correctly?
			Temperature display reading cannot be trust. 1. Display indicates 60 °C. 2. Display indicates 1 °C. 3. Display indication not in line with Keg temperature.	Problem: <ol style="list-style-type: none"> 1. NTC has short circuit. 2. NTC has open circuit. 3. See chapter SERVICE TESTROUTINES step mode 2 how to check the system.
3	Blinking display or pump is "to" often activated. (Air Leakage)	Check if air leakage is found internal the appliance.		
		1. Remove the Keg and tap unit. 2. Block the air Inlet coupling at the Keg side. 3. Actuate the KEG present switch after ±10 seconds the pump will start running shortly (depending on air leakage). 4. Wait ± 300 sec. 5. Check if the pump is not running the air leakage is probable external.	If the leakage is caused internally the following parts must be checked. <ol style="list-style-type: none"> 1. Leakage hose and/or hose connections. (Hairline cracks) 2. Leakage in air coupling. 3. Leakage in the pump and/or connections. 4. Defective air pressure sensor. 	
		Air leakage external:		
		Parts that could cause the external air leakage are: Tap unit, keg and air coupling.	<ol style="list-style-type: none"> 1. Leakage in connection air coupling - Tap unit. 2. Leakage in connection Keg - Tap unit. 3. Leakage in the Keg. 	

	Problem	Cause	Repair solution
4	Cooling problems.	Cool down process takes very long.	
		Check if the user conditions were carried out according the DFU.	<ol style="list-style-type: none"> 1. Check if there is 10 cm free space around the appliance. 2. Check if the ambient temperature did not exceed 32 °C. 3. Check if the fan is turning well and there is no blockage caused by dust or other particles. 4. Check if the Fan is correct placed (air flow direction)
		Unit doesn't cool down.	
		Possible root causes: <ol style="list-style-type: none"> 1. Peltier element became defect. 2. NTC sensor became polluted or defective. 3. Fan, heat sink is full of dust. 4. Fan became defect. 	Check/replace the defective parts. <ol style="list-style-type: none"> 1. Perform the cooling test as described on page 6. 2. Clean the NTC See chapter SERVICE TESTROUTINES step mode 2 how to check the system or see point 5 “Temperature display reading cannot be trust” in the table below. 3. Check if the fan is turning well and there is no blockage caused by dust or other particles. 4. Exchange fan and Peltier element.
5	Temperature display reading cannot be trust.	System check by means of external temperature meter.	<ol style="list-style-type: none"> 1. Place temperature sensor next to the location of the NTC assy. 2. Place keg and plug appliance on. For the best result start measurement if appliance reached display reading below 10 °C. 3. Read out the external temperature meter and the display value of the appliance. 4. Subtract a 2.4 °C from the external temperature reading and compare the values. Deviation aloud +/- 1 °C, below 3 °C - 1 °C / +2 °C. 5. Example: External indication temperature 7.4 °C Display reading PerfectDraft system 5 °C Conclusion (7.4 reading ext. - 2.4 offset value) = 5 °C, appliance within spec.
6	Beer leakage.	<ol style="list-style-type: none"> 1. Leakage spout side. 2. Leakage on top of the Keg. 	<ol style="list-style-type: none"> 1. Check beer tube on hairline cracks or check closing mechanism tap unit. 2. Check beer tube, tap unit and Keg.
7	Condensation water leakage.	Through the cooling process condensation water is formed and can drip under the appliance.	<ol style="list-style-type: none"> 1. Check if doors were closed properly. (If not closed extra condensation will be build) 2. Check if the drip tray was well placed.
8	Beer volume indication.	<ol style="list-style-type: none"> 1. After usage of beer the volume indicates 100% again. 2. There is still beer left in the Keg and the indicator is displaying no beer left 0 %. 3. Volume reading is not trustworthy. 4. Can I adjust the indication? 	<ol style="list-style-type: none"> 1. Through a voltage dip or appliance has been switched off the default value (100 %) will be displayed again. (after pouring one glass of Beer the right volume will be displayed again) 2. This is normal appliance is adjusted that way. 3. The volume indication is a rough indication; through air leakage problems the volume indication become inaccurate. 4. No the volume indication cannot be adjusted.

	Problem	Cause	Repair solution
9	No foam on the Beer.	Check the following conditions.	1. Temperature of the Beer must be below 9 °C. 2. Glasses have to be clean. 3. Beer tube connector is not properly installed or is damaged. Check DFU for more tips.
10	To much foam.	Check the following conditions.	1. Temperature of the Beer must be below 9 °C. 2. Beer tube connector is not properly installed or is damaged. 3. Check if there is no air leakage in the system. 4. When the keg is almost empty it is possible that only foam will come out. Check DFU for more tips.

PARTS LIST

Pos	Service code	Description
1	9965 000 44301	Back cover
2	9965 000 44302	Right Door assy
3	9965 000 44303	Left Door/display assy
4	9965 000 44304	Connector/Lever assy
5	9965 000 26126	O-ring 11X2 Air inlet side
6	9965 000 32659	O-ring
7	9965 000 44305	Handle assy
8	9965 000 26122	Handle O-ring
9	9965 000 44306	Tap unit
10	9965 000 26124	Spout O-ring
11	9965 000 26123	Spout
12	9965 000 44307	Steel driptray cover
13	9965 000 44308	Driptray
14	9965 000 44309	NTC sensor assy
15	9965 000 26117	Pressure sensor PCB assy
16	9965 000 26115	Grommet. Pump position
17	9965 000 26116	Pump assy
18	9965 000 44310	Power supply HV 220 - 240 V
19	9965 000 26111	Micro switch assy
20	9965 000 44311	Main PCB
21	9965 000 32874	Drop ring
22	9965 000 26110	Grommet, FAN position
23	9965 000 26109	Fan assy
24	9965 000 26119	Peltier assy

