

Service Manual

 QUARTZ Synthesizer

Direct Drive Automatic Turntable System

SL-1300MK2 (M)



• The model SL-1300MK2 (M) is available in America only.

SPECIFICATIONS		(Specifications are subject to change without notice for further improvement)	
General		Speed drift	Within 0.002%
Power supply	AC 120 V, 50 or 60 Hz	Wow and flutter	0.025% WRMS (JIS C5521) ±0.035% weighted zero to peak (DIN 45507)
Power consumption	12 W	Rumble	-50 dB (DIN 45539A) -73 dB (DIN 45539B)
Dimensions (H x W x D)	14.5 x 45.3 x 38.4 cm (5-45/64 x 17-45/64 x 15-7/64 inches)	Tonearm section Type	Gimbal suspended universal "S" shaped tubular arm, static-balanced type
Weight	11.8 kg (26.0 lb)	Effective length	230 mm (9-1/16")
Turntable section Type	Quartz-phase-locked control direct drive automatic turntable with quartz synthesizer pitch control, Automatic start, Automatic return, Momo-repeat play and Manual play	Overhang	15 mm (19/32")
Drive method	Direct Drive	Tracking error angle	+3° at the outer groove of 30 cm (12") record +1° at the inner groove of 30 cm (12") record
Motor	Brushless DC motor	Offset angle	21.5°
Drive control method	Quartz-phase-locked control	Friction	Less than 7 mg (lateral, vertical)
Turntable platter	Aluminum die-cast, diameter 33 cm (13"), weight 2.5 kg (5.5 lb.)	Effective mass	22 g (with a cartridge weighing 6 g at 1.75 g stylus pressure)
Moment of inertia	340 kg-cm ² (116 lb-in ²)	Tonearm height adjust- ment	1 mm steps a range of 6 mm
Turntable speeds	33-1/3 and 45 r.p.m.	Adjustable stylus	0 ~ 3 g
Turntable speed fine adjustment	Adjustable up to ±9.9% in 0.1% increments by digital indication	pressure range	
Starting torque	1.5 kg-cm (1.3 lb-in)	Cartridge weight range	5-11 g
Build-up characteristics	90° or 1/4 rotation to 33-1/3 rpm	Cartridge mounting	12.7 mm (1/2") mounting space
Braking system	Electronic brake	dimensions	
Speed fluctuation due to load torque	0% within 1.5 kg-cm (1.3 lb-in)	Headshell terminal lug	1.2 mm, for 4-pin terminal

Technics
by Panasonic

Panasonic Company
Division of Matsushita Electric
Corporation of America
One Panasonic Way, Secaucus,
New Jersey 07094

Matsushita Electric of Hawaii, Inc.
320 Waiakamilo Road, Honolulu,
Hawaii 96817

Matsushita Electric of Canada Ltd.
40 Ronson Drive, Rexdale,
Ontario, Canada M9W 1B5

■ FEATURES

Encounter two separate isolation stages. The first stage effectively damps out harmful external vibrations which may reach the unit through its resting surface. The all-important turntable, motor and tonearm assembly are then supported on a second isolation system. These isolators are specially designed with material and springs of calculated, finely-tuned elasticity to absorb external vibrations.

Isolation from feedback lets you enjoy clear, transparent sound even at high volume levels.

Technics unique motor construction in which the rotor of the motor is integrally formed with the turntable.

High torque motor delivering 1.5kg·cm makes it possible to reach 33-1/3 r.p.m. from standstill within 0.7 sec. (1/4 rotation) and to effect instantaneous speed change. (Fig. 1).

Superior load characteristic of 0 rotational deviation even at a stylus pressure of 300 g. (Fig. 2).

High performance with wow and flutter of only 0.025% (JIS C5521) and rumble of -73 dB (DIN 45539B).

Since the development of the DD turntable, Technics has continually strived for further improvement of player performance and has introduced numerous high performance models on the market.

The SL-1300MK2 series is brought into being by combination of experience and research.

The characteristic values of rumble -73 dB (DIN 45539B) and wow and flutter of 0.025% (W.R.M.S JIS C5521) by far exceed the standards to which record albums are made.

Quartz Controlled Rotation Accuracy

The SL-1300MK2 utilizes the oscillation of a quartz crystal as a reference signal or source. This oscillation is not affected by temperature change or power fluctuations. By synchronizing the rotation of the turntable platter accurately to the reference signal, speed drift of the SL-1300MK2 is held within $\pm 0.002\%$. This means that for a record with a playing time of 30 min, total playing time variation can amount to no more than 0.036 sec. This stable and accurate rotation sets a new standard of precision.

The accuracy under controlled operating conditions as in a listening room is about $\pm 0.00001\%$ as shown in Fig. 3.

Highly sensitive universal tonearm.

For the finest tracking sensitivity, the tonearm rests in a gimbal suspension equipped with two pairs of low friction pivot bearings. Gimbal suspension and low tonearm mass means that accurate tracking is possible at tracking forces as low as 0.25 grams. With enhanced rotational sensitivity of 7 mg. the tonearm is allowed free, gyroscopic movement to ensure flawless balance during tracking. The longer-than-usual effective tonearm length (9-1/16" or 230 mm, stylus to pivot) contributes to the arm's low tracking error, and this in turn facilitates the design of the anti-skating control for precise and reliable tracking. With this design, a single precise anti-skating scale counteracts side thrust for all types of styli.

Arm height is adjustable within a range of 6 mm to accommodate varying cartridge dimensions.

Resonance dampened headshell with unique overhang adjuster.

Low capacitance phonocables.

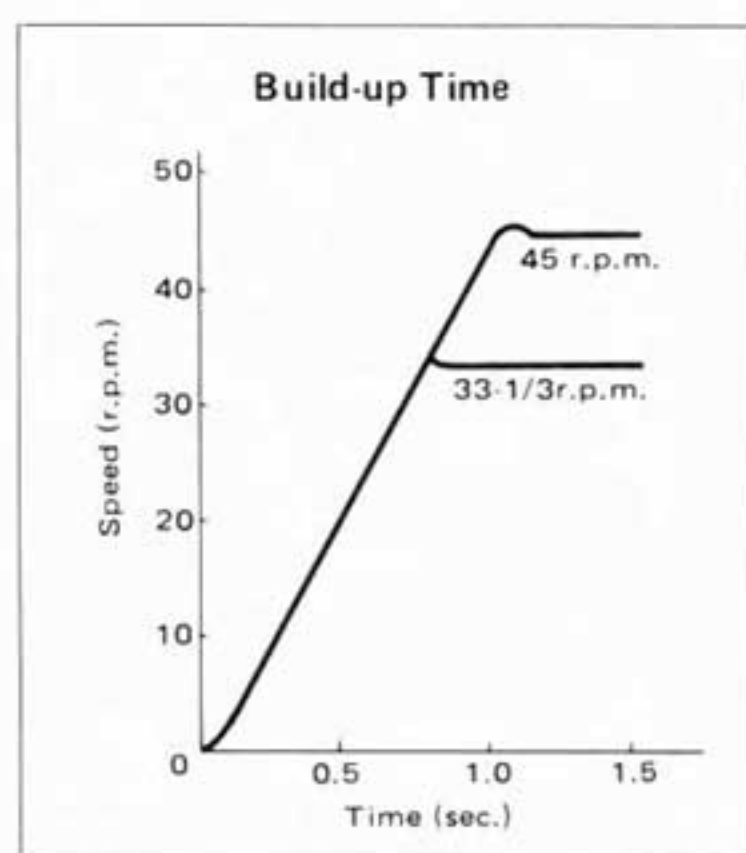

Fig. 1

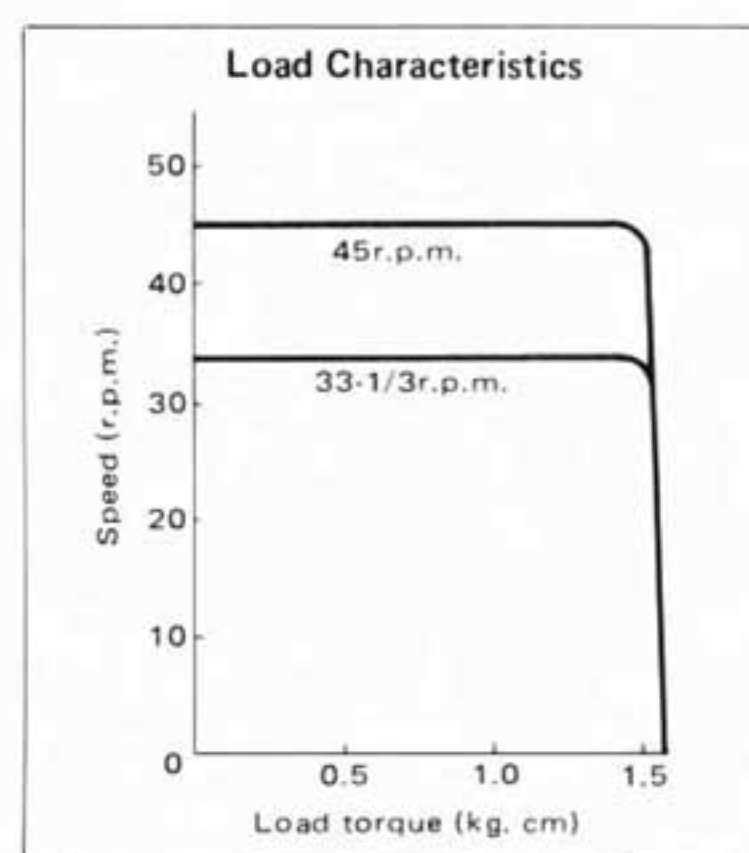

Fig. 2

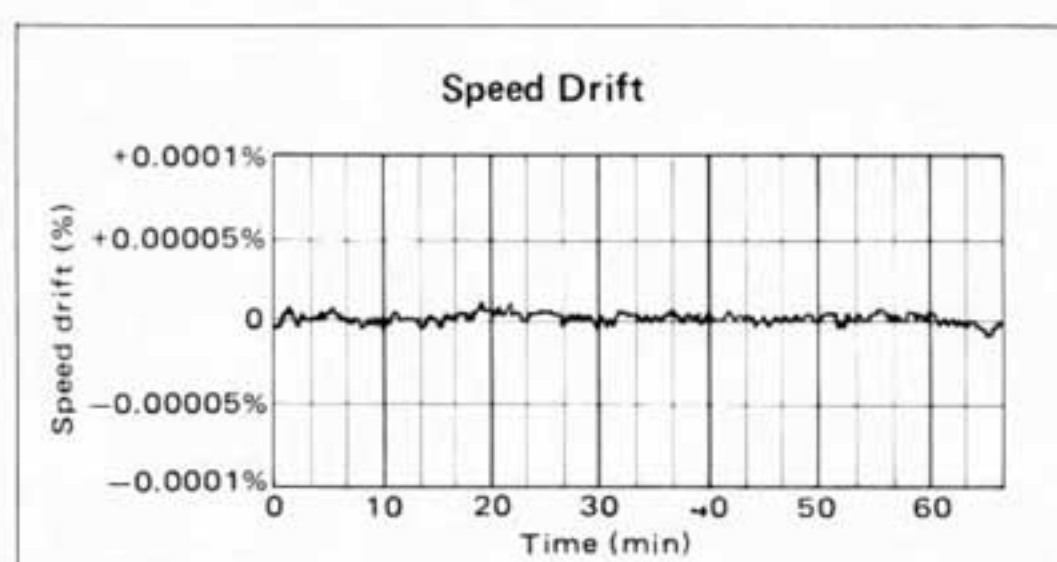

Fig. 3

■ CROSS SECTION OF MOTOR PORTION AND DOUBLE INSULATOR

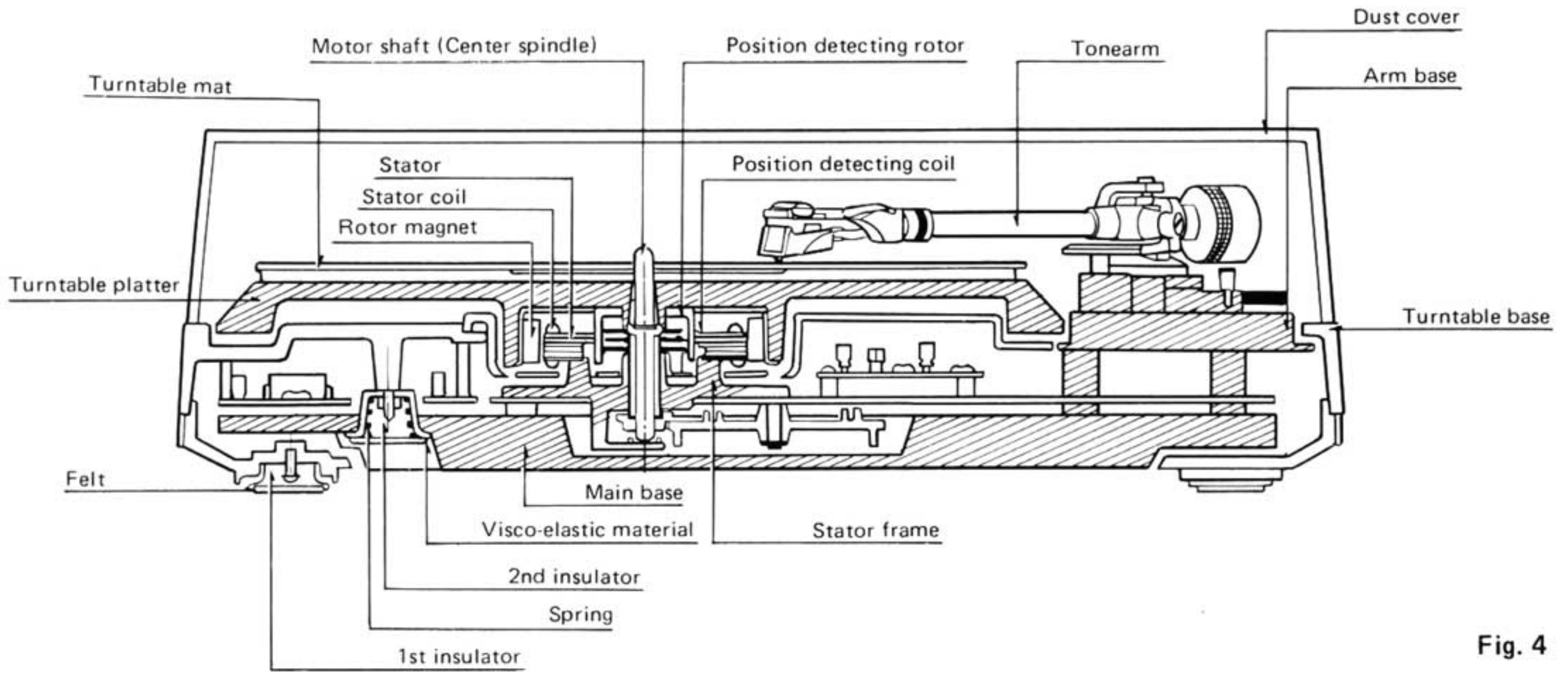

Fig. 4

■ PARTS IDENTIFICATION

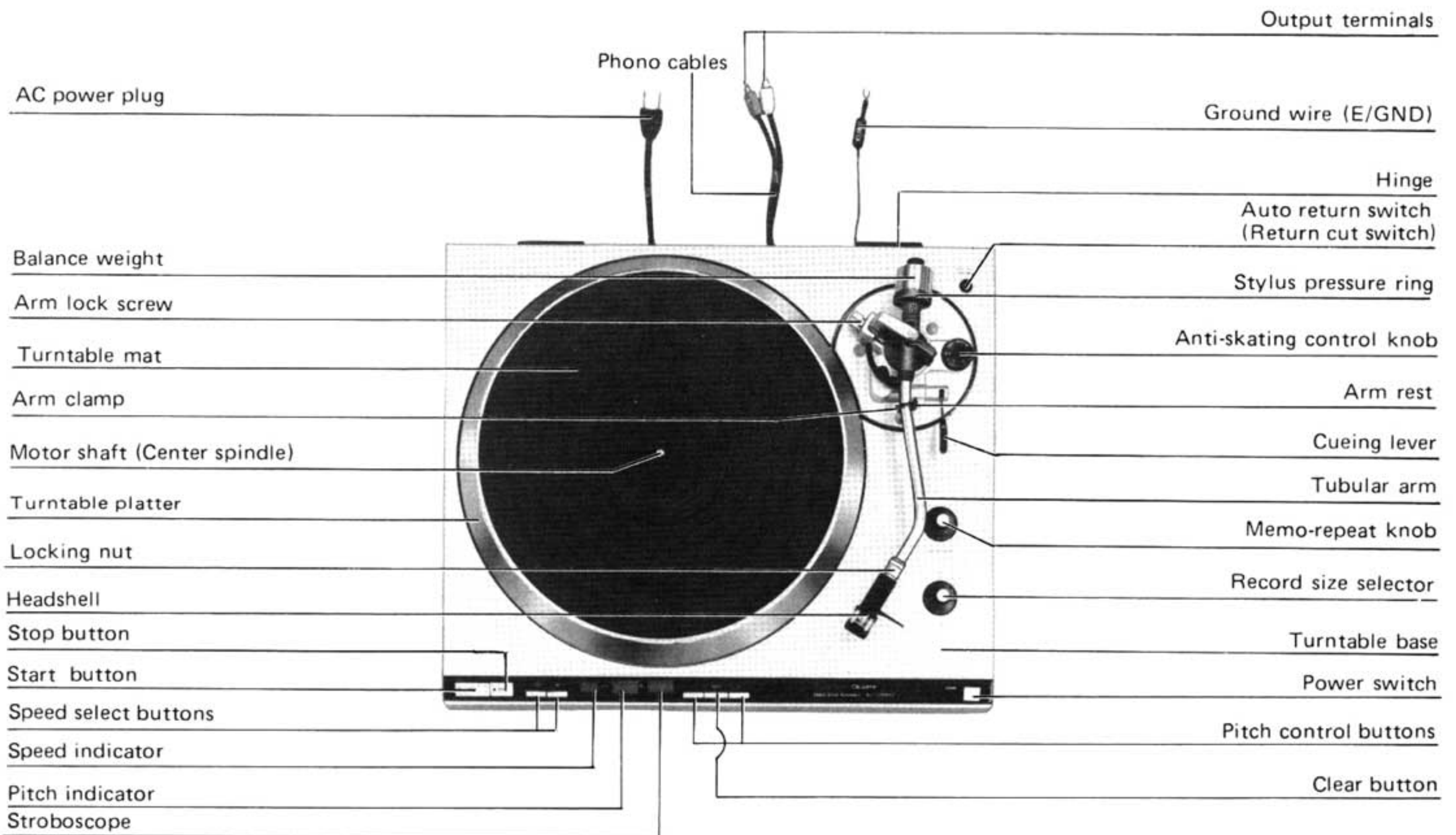

Fig. 5

■ TO REMOVE CABINET AND BOTTOM COVER

1. Remove headshell and balance weight.
2. Clamp tone arm to the arm rest.
3. Remove turntable platter.
4. Close dust cover.
5. Turn unit upside down taking special care not to damage or scratch the dust cover.
6. Remove the 7 screws from bottom cabinet (Fig. 6).
7. Remove the 4 screws from main base (Fig. 7).
8. Holding the player firmly with both hands, to prevent separation of upper section (turntable base) from lower section (main base), turn it carefully upwards.
9. Remove dust cover.
10. Remove the 6 screws from the panel cover (Fig. 8).
11. Unplug the 5 plug-in connectors and 1 cord clamp (Fig. 9).
12. To remove the turntable base from the main base bottom section, turn cueing lever upward (cueing position) and move tone arm towards center of spindle. Top section can be lifted up easily.
13. To reassemble, perform steps 1 through 12 in reverse.

Note:

The turntable horizontally to the panel face is already adjusted before shipment. If deviated, correct it by means of the adjust screws using a 5 mm box spanner.

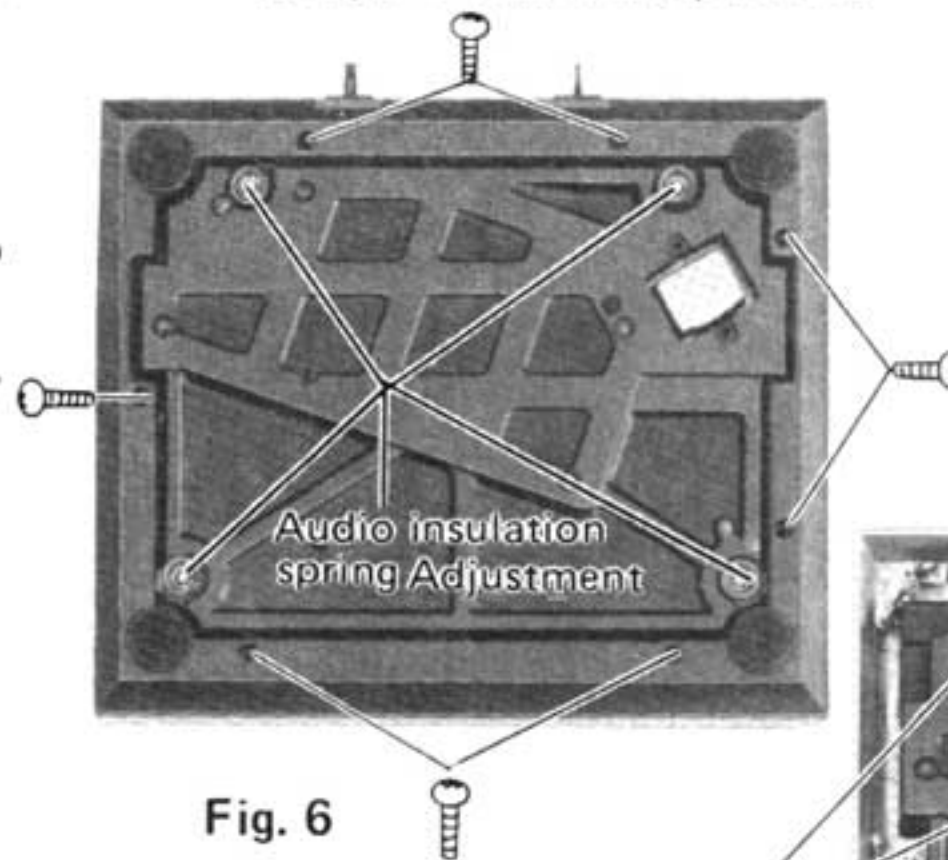

Fig. 6

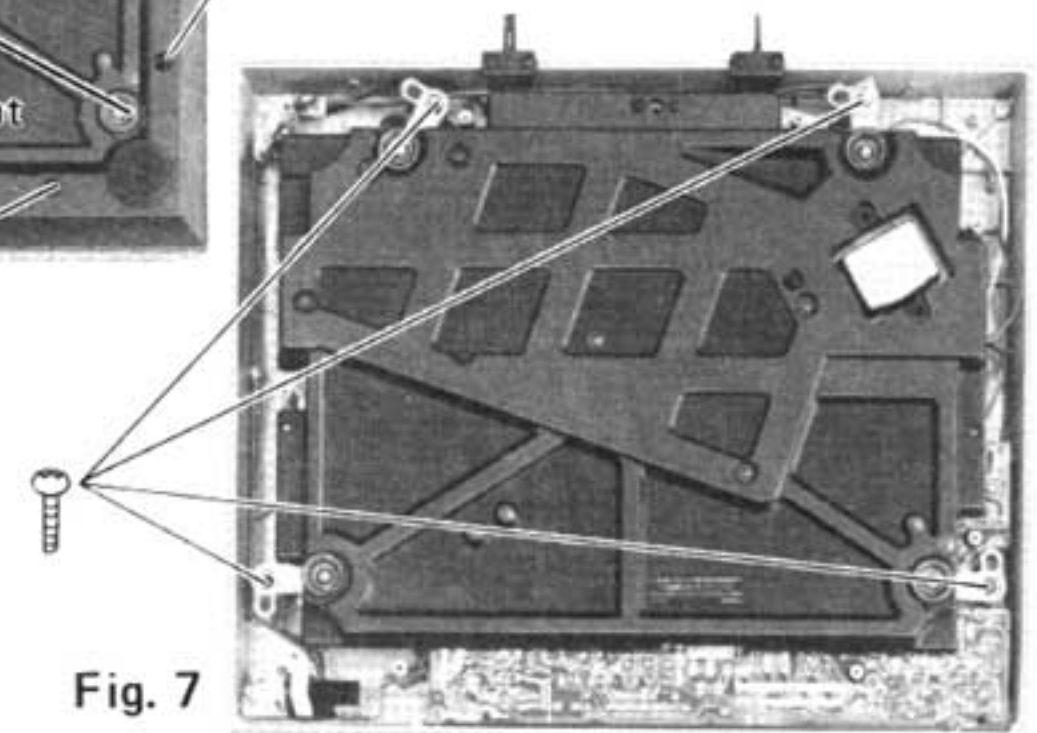

Fig. 7

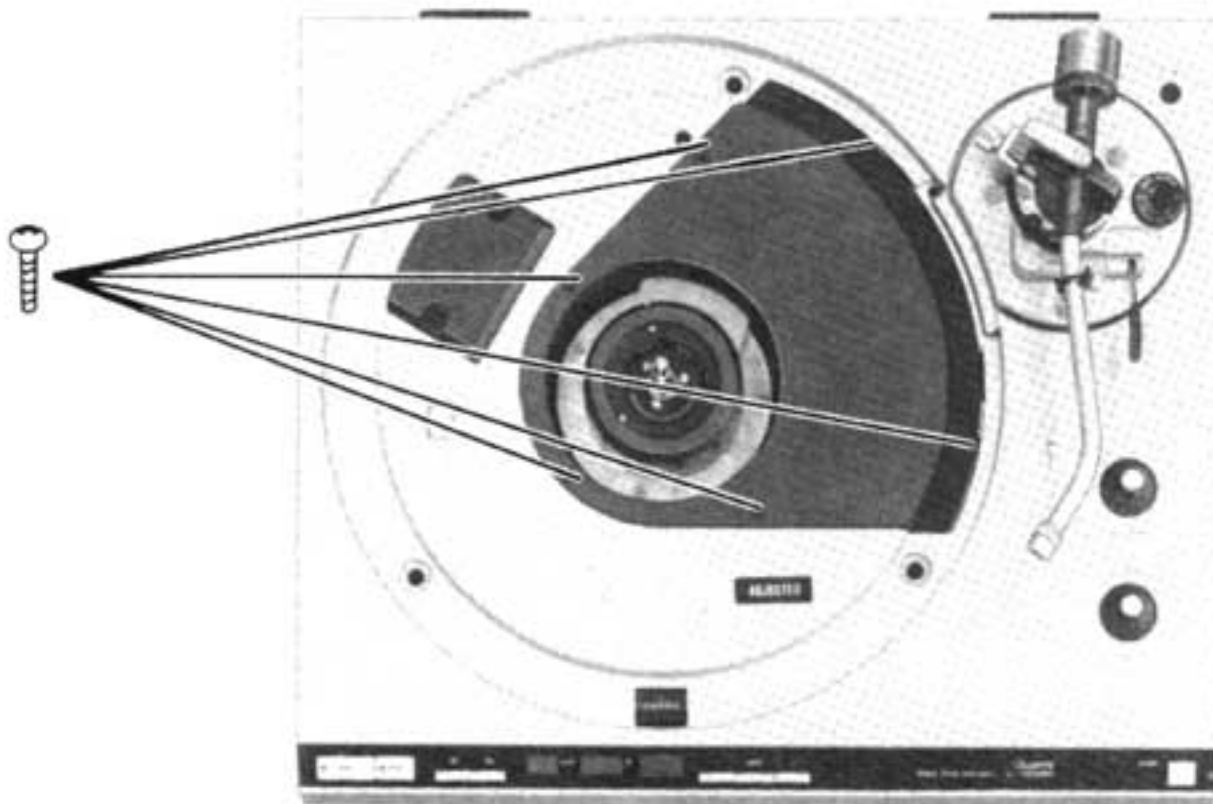

Fig. 8

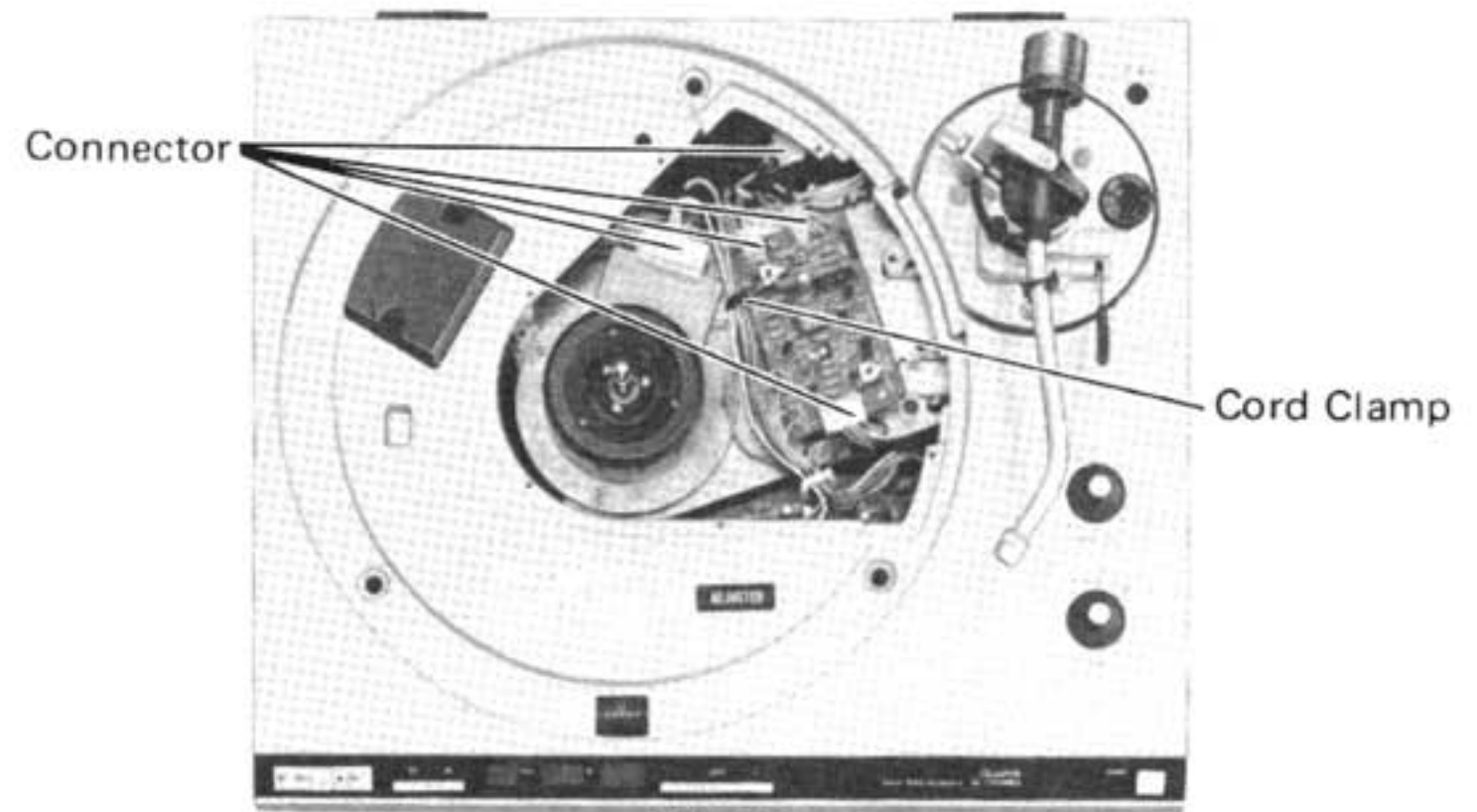

Fig. 9

■ CONNECTOR CONNECTION POINTS FOR INSPECTION

Connect the disassembled main unit and main base as shown in the Figure below.

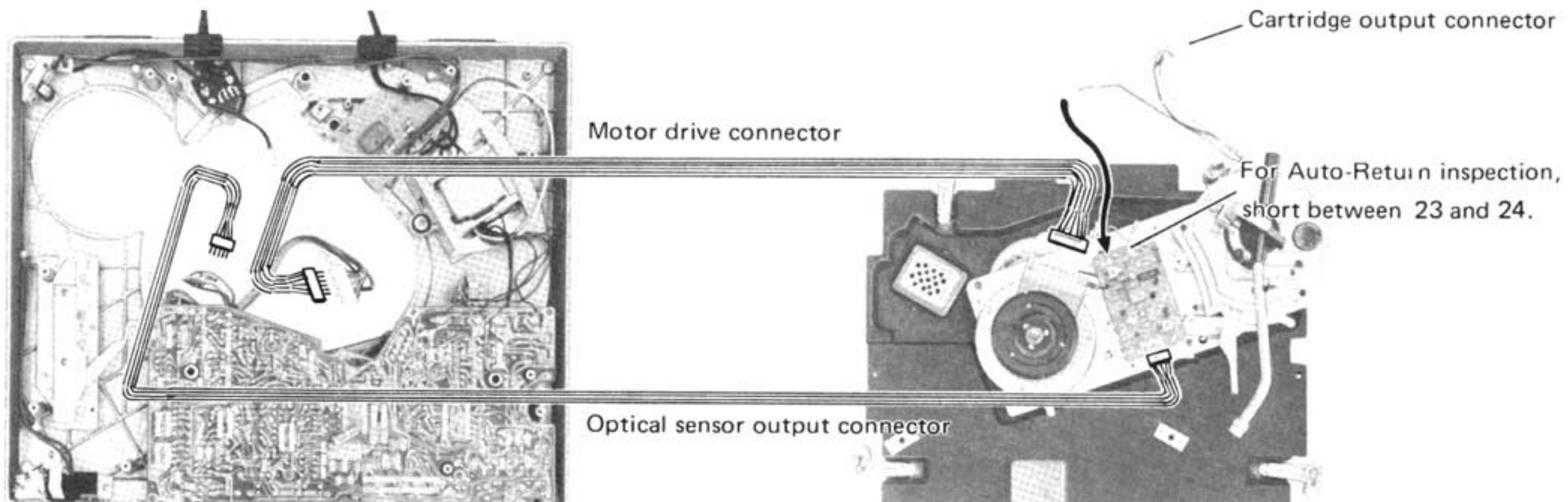

Fig. 10

■ HOW TO PLAY

Manual play

Place a record on the turntable platter.

Push the 45 r.p.m. speed select button if you play a 45 r.p.m. record. (See Fig. 11).

Note:

Since the unit has been designed to select 33-1/3 r.p.m. automatically each time you push the power switch on, push the speed select button if you play a 45 r.p.m. record.

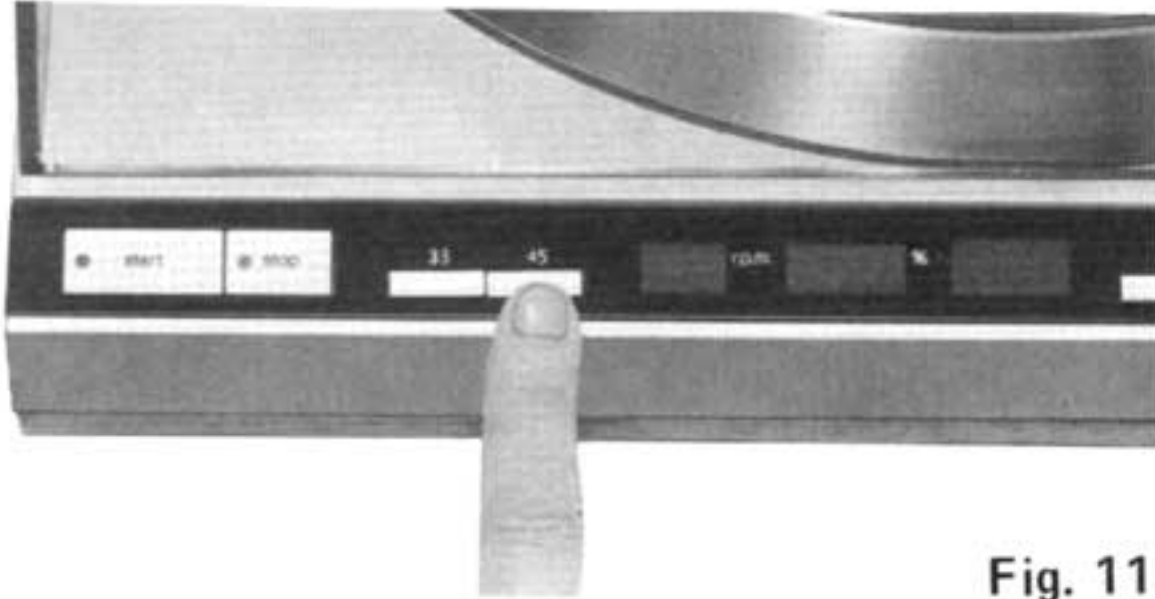

Fig. 11

Move the tonearm manually over the record, the turntable will start to rotate. Lower the cueing lever.

The tonearm will descend slowly onto the record and play will begin.

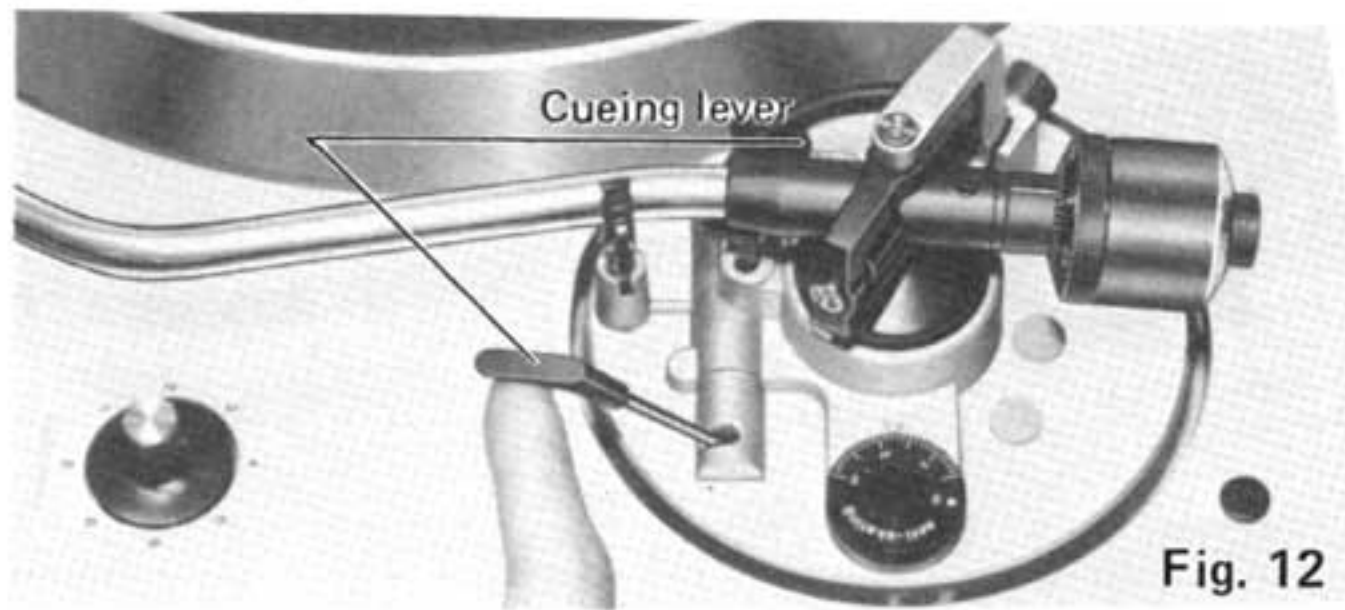

Fig. 12

When finished, the tonearm will automatically return to the arm rest (auto return) and the turntable platter will stop rotation.

Note:

- To shut the power off the power switch must be pushed again to the off (■).
- If the "memo-repeat" knob is in a position other than "0", play will be repeated by the number of time set, therefore, be sure to keep the "memo-repeat" knob in the "0" position.
- If you play a 45 r.p.m. record with a large center hole, use the furnished adaptor on the center spindle.

Automatic play

Push the power switch to the ON position (■).

The speed indicator for 33-1/3 r.p.m. the pitch indicator and stroboscope will all light up.

Place a record on the turntable platter.

Release the arm clamp.

Remove the stylus cover if your cartridge has one.

Set the record size selector to the diameter of the record (7", 10" or 12") you wish to play.

Push the start button. (See Fig. 13).

The tonearm will move and descend according to the size selected and start play (Automatic start).



Fig. 13

When finished play, the tonearm will automatically return to the arm rest and the turntable platter will stop rotation.

Note:

- Records with dimensions other than 7" (17 cm), 10" (25 cm) and 12" (30 cm) diameter must be played "Manually".

Repeat play

This unit employs a unique feature the "Memo-repeat". You can play a record repeatedly from one to six times or continuously by setting this knob to the desired position.

Set the "memo-repeat" knob to the desired number you wish to play. (See Fig. 14).

"R" position enables you to repeat play continuously.

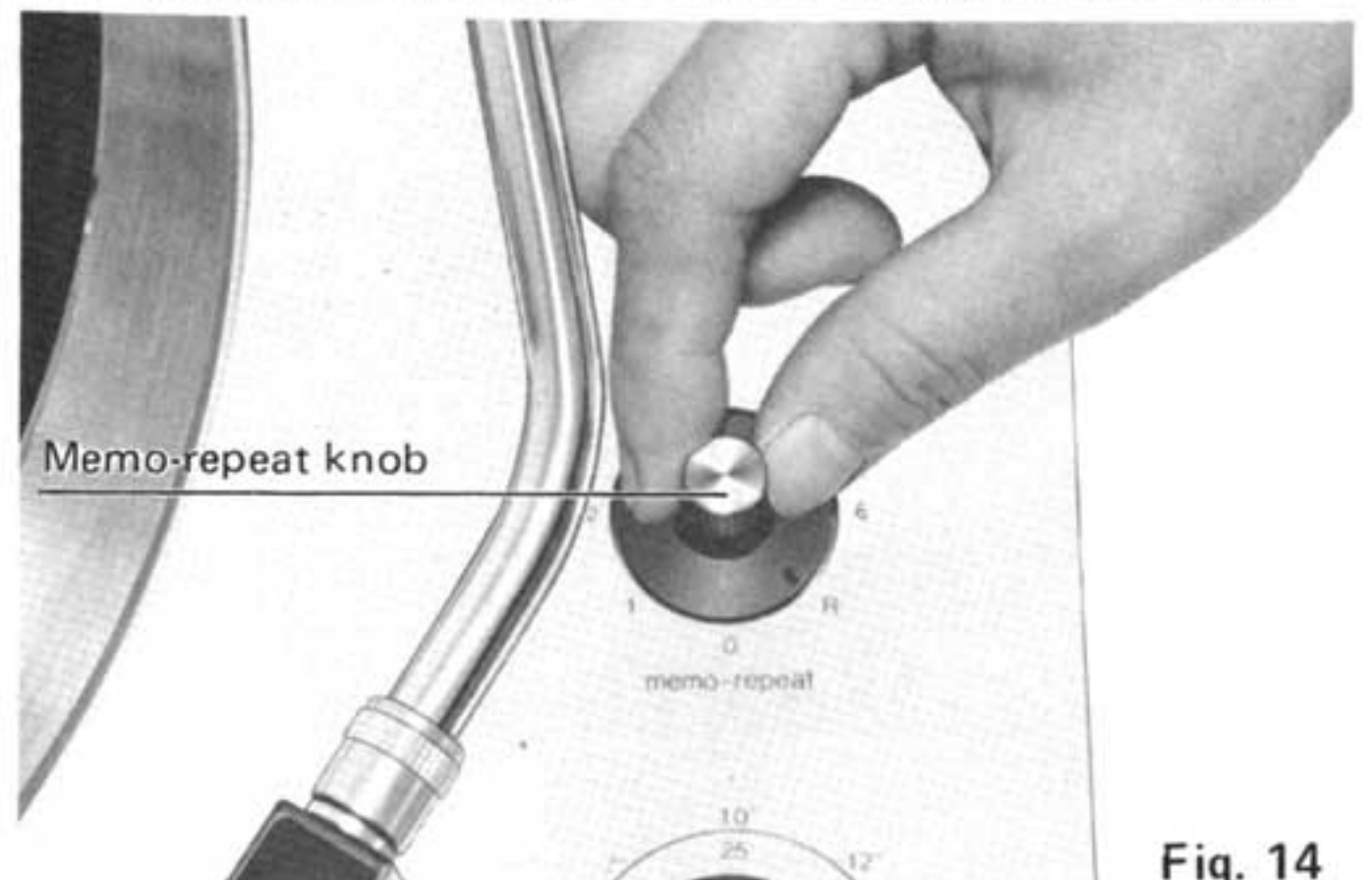

Fig. 14

Note:

For suspension of play, be sure to push the stop button after having set the "memo-repeat" knob to "0".

■ HOW TO USE AUTO RETURN SWITCH

This unit employs a unique "auto return switch" (return cut switch).

- Should any phono disc whose central hole is off center be played, the tonearm will automatically return during the course of performance. In such a case, set the auto return switch to the OFF (■) position (see Fig. 15), and then the phono disc can be played to the final groove.



Fig. 15

Note:

For restoring the normal auto return function, set the switch back to the ON (—) position.

■ ADJUSTMENTS-1

Adjustment of the arm height. (See Fig. 16, 17)

- This tonearm has been locked in the highest position before shipping from the factory, adjust the arm height according to your cartridge height.
- Loosen the arm lock screw. And push the arm pivot bearing support downward until the tonearm is parallel with the record surface.

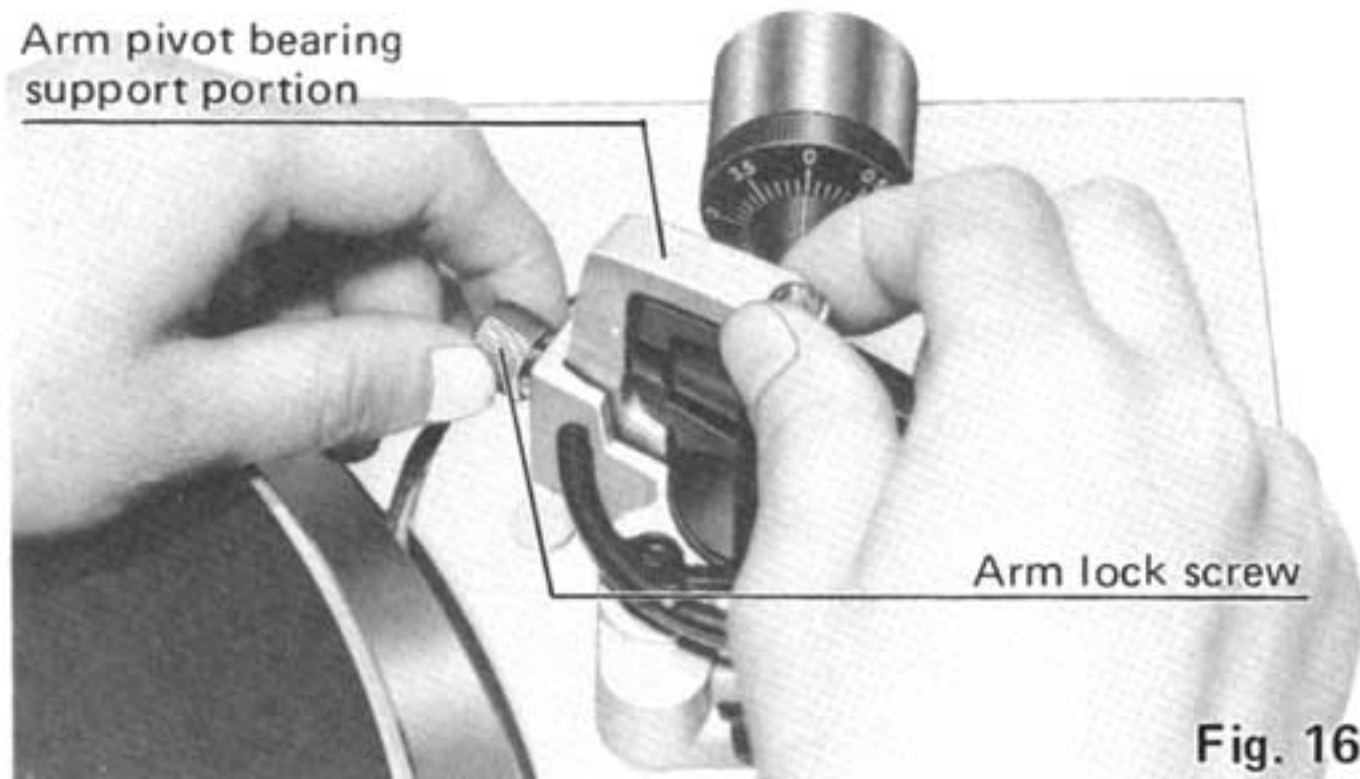

Fig. 16

■ ADJUSTMENTS-2

Pitch control (turntable speed fine adjustment)

By the employment of the Quartz Synthesizer pitch control for being employed for the first time in the world, a high degree of pitch control accuracy over a range as wide as $\pm 9.9\%$ in 0.1% increments can be obtained independently, with the quartz locked speed accuracy.

■ HOW TO SUSPEND AND STOP PLAY

- For temporary suspension of play, raise the cueing lever, and the stylus tip of the cartridge, will lift from the record.
- For suspension of play, push the stop button. The tonearm automatically returns to the arm rest and the turntable stops rotating.

Note:

The stop button will light up after the tonearm returns to the arm rest.

- If the cartridge height is 18 mm as shown in the picture, lock the arm bearing support at the line indicated in the picture. (See Fig. 17) The arm height can be adjusted in 1 mm increments over a range of 6 mm.

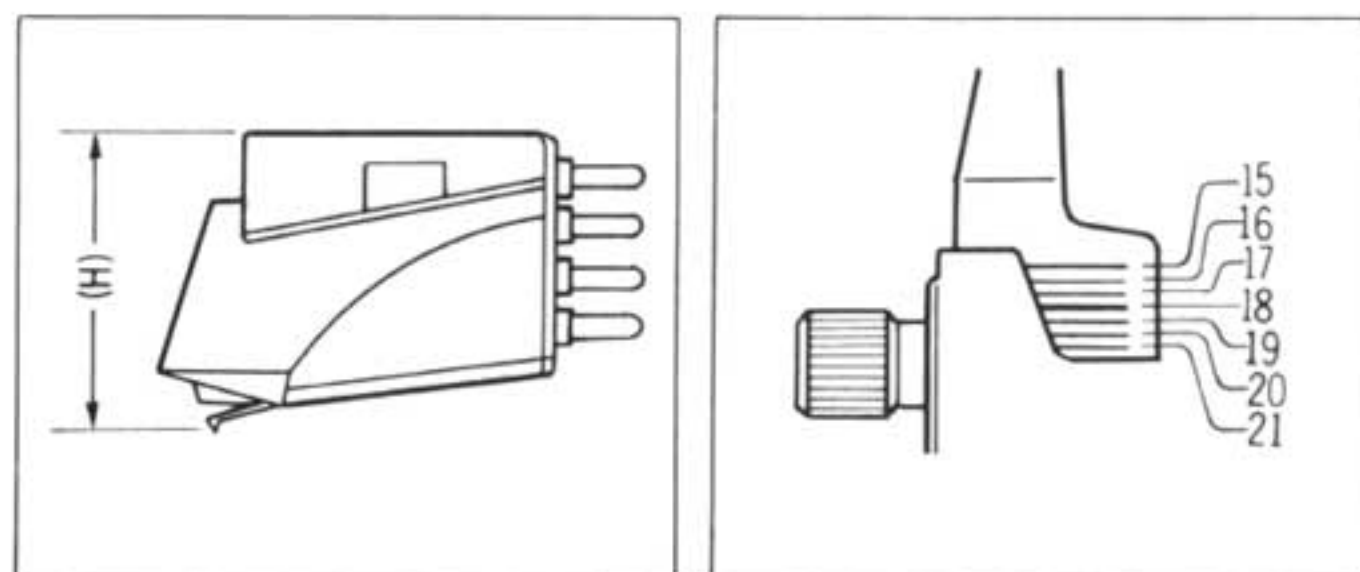

Fig. 17

Additionally, the pitch variations which are clearly indicated by the LED digital indicator provide you with accurate and easy selection.

- The pitch control can be selected in increments of 0.1% which is below the threshold of human perception. This function can be very effective for minor extension or reduction of broadcasting time in professional applications.

- The pitch control also enables you to accurately and precisely tune with musical instruments, and by varying the pitch slightly to obtaining a different musical note from phono disc.

For a half tone change:

+5.9% (#)

-5.6% (b)

- Another feature of the variable pitch control over a wide range of $\pm 9.9\%$ is that it makes singing along with a melody easy for a choral or playing a phono disc for accompaniment only.

By pressing the clear button which is located between the "+" and "-" pitch buttons, you can quickly return the set to normal playing speed.

Adjustment of the muting time and arm height.

(See Fig. 18 and 19)

This unit employs "muting switch" combination with arm lift to cut off the irritating noise when the stylus is set down on or lifted up from the record. You can adjust the muting time by adjusting the arm lift height (distance between the stylus tip and record surface when cueing lever is raised).

If the clearance becomes too narrow or too wide because of the physical size of the different cartridge on the market, turn the adjustment screw clockwise or counterclockwise, while pushing the arm lift down.

Clockwise rotation

- distance between the record and stylus tip is reduced, and muting time becomes longer.

Counterclockwise rotation

- distance between the record and stylus tip increases, and muting time becomes shorter.

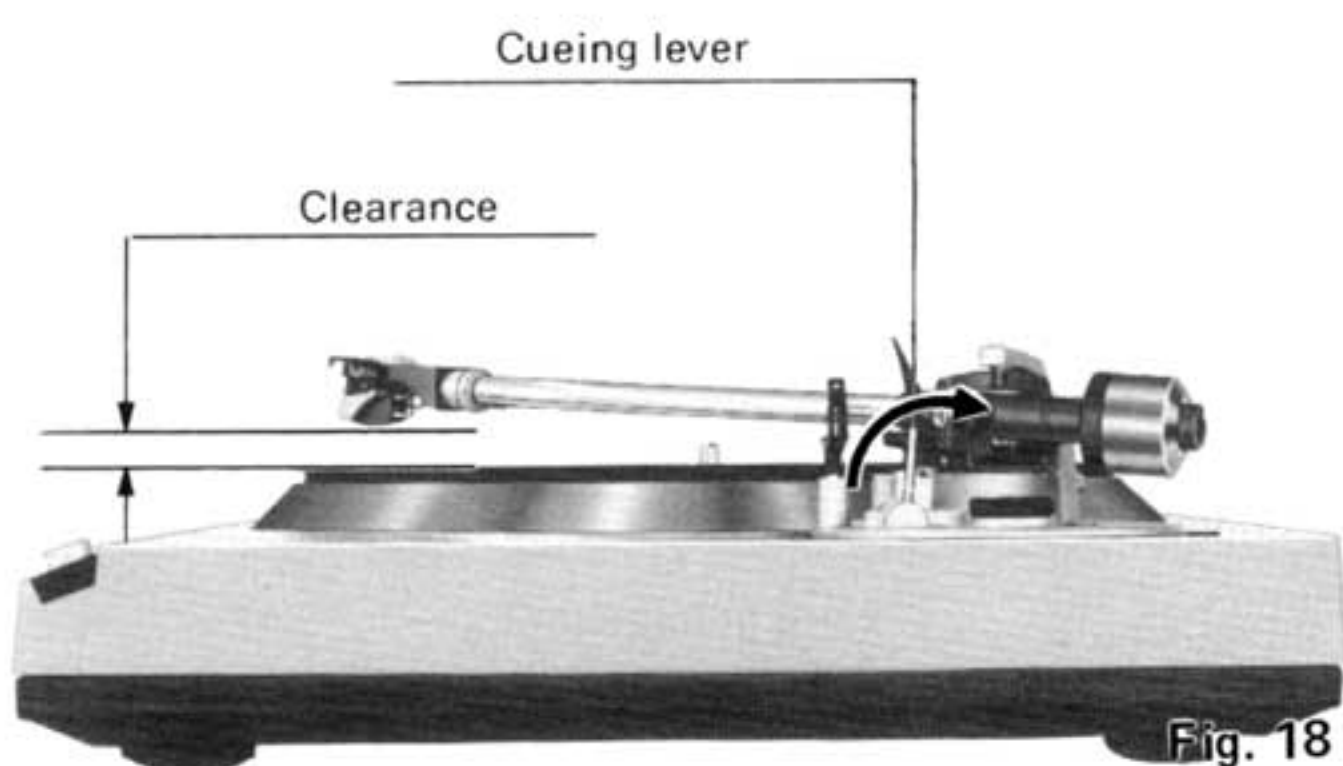

Fig. 18

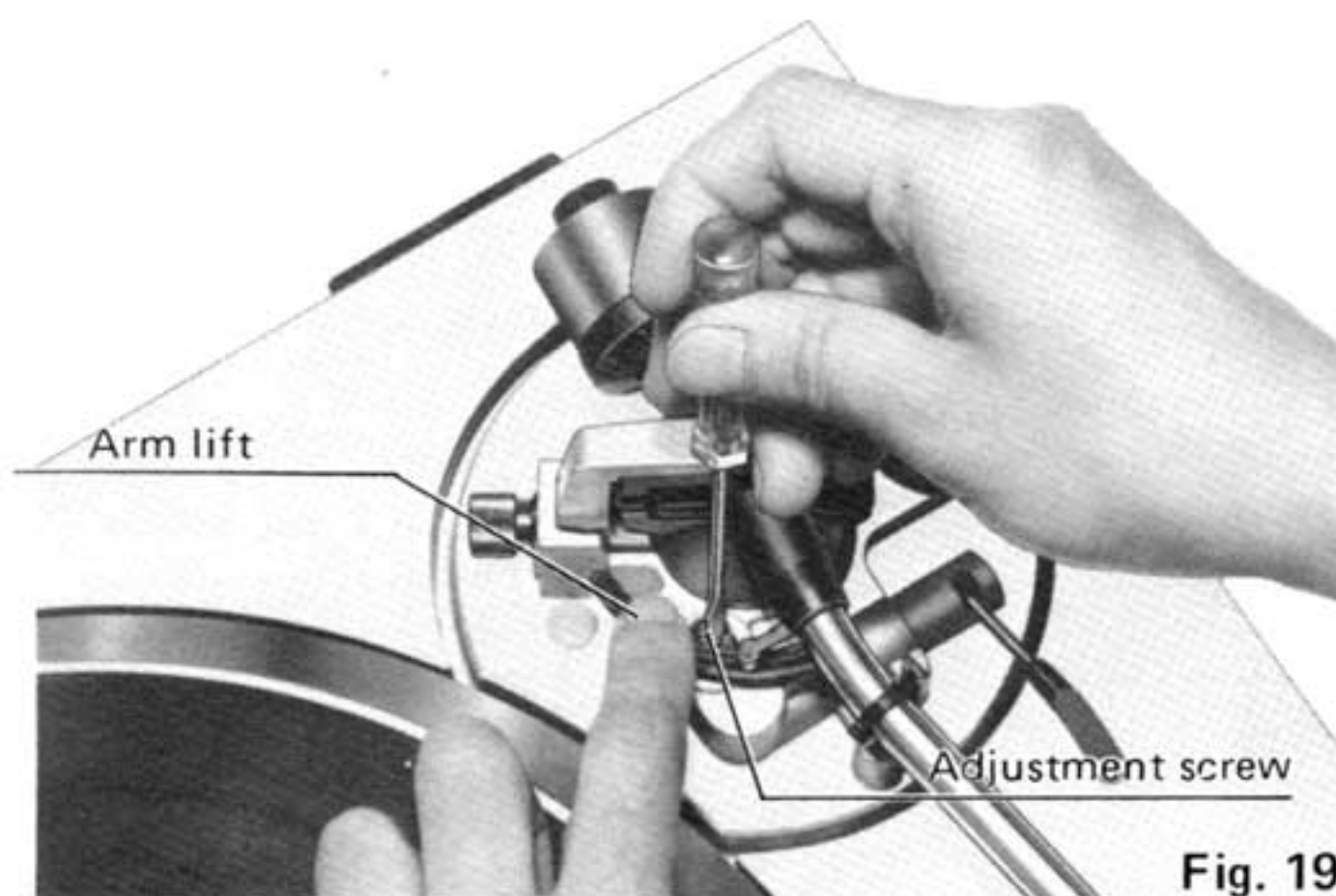

Fig. 19

Note:

As the adjusting screw has a hexagon head, be sure to make the adjustment while depressing the arm lift, and be sure that the hexagon head retract correctly into the arm lift when released.

Adjustment for automatic start and automatic return positions.

Should the tonearm not set down or lift off at the correct points, make adjustments according to the following procedures.

Adjustment for automatic start position (See Fig. 20).

1) Keep the power switch turned OFF (■) to prevent the turntable from rotation.

2) Remove the rubber cap.

In cases where the stylus tip sets down outside of the record.

- Move counterclockwise.

In cases where the stylus tip sets down on the recorded groove. -Move clockwise.

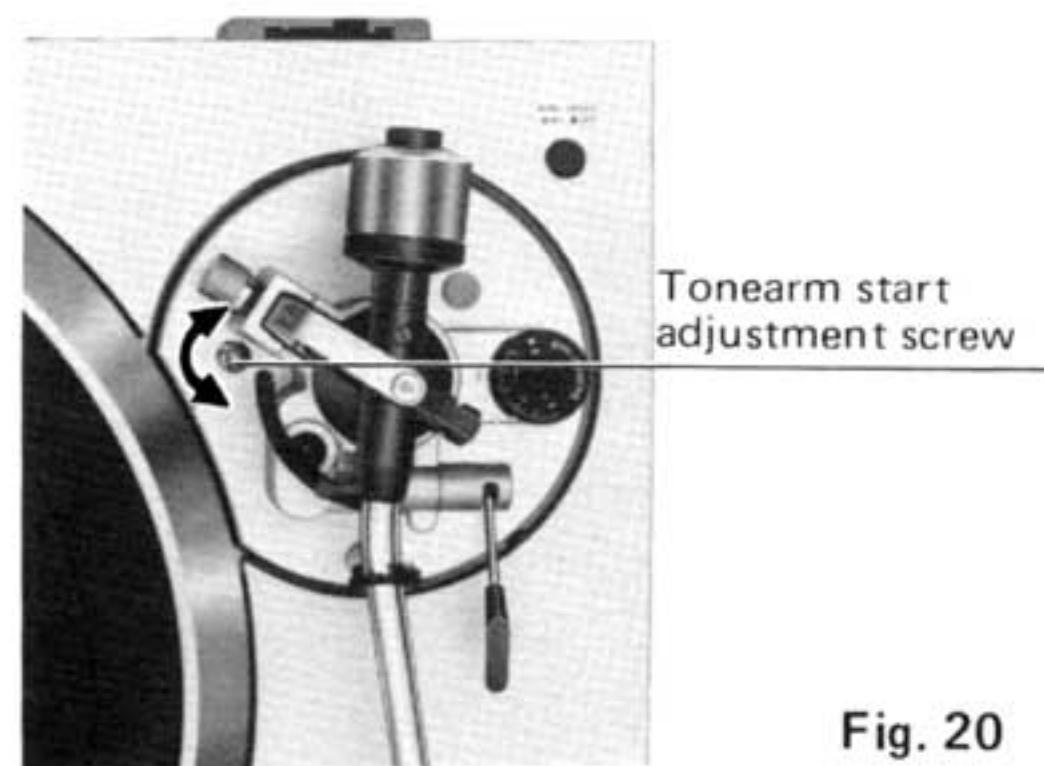

Fig. 20

Adjustment for automatic return position (See Fig. 21).

1) Keep the power switch turned OFF (■) to prevent the turntable from rotation.

2) Remove the rubber cap.

3) Move the tonearm toward the center spindle side, and make the adjustment by gradually turning the adjusting screw.

In cases where the tonearm tends to return before the playing has finished.

- Move counterclockwise.

In cases where the tonearm fails to return after the last groove of the record.

- Move clockwise.

Note:

Never turn the screw over a 180-degree angle.

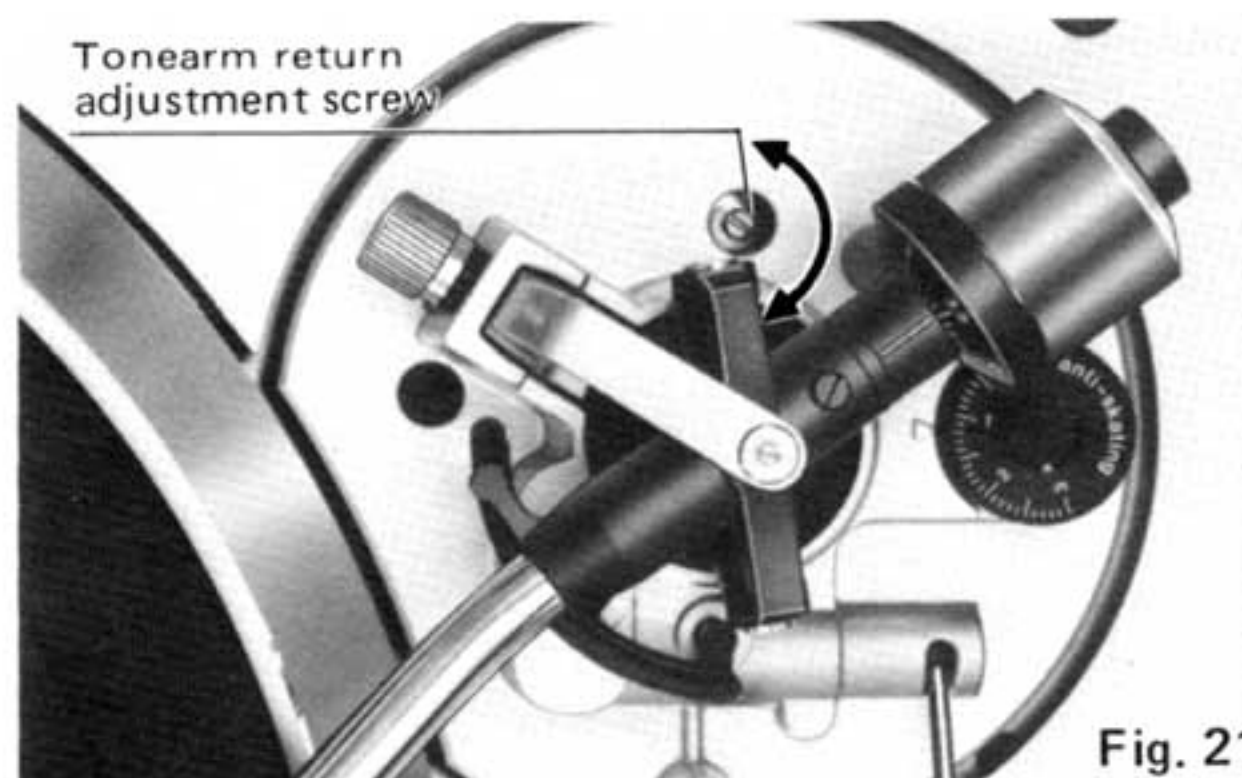
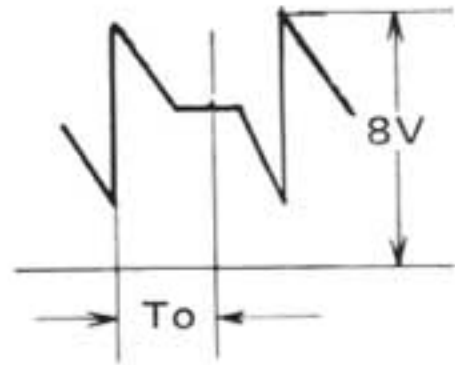
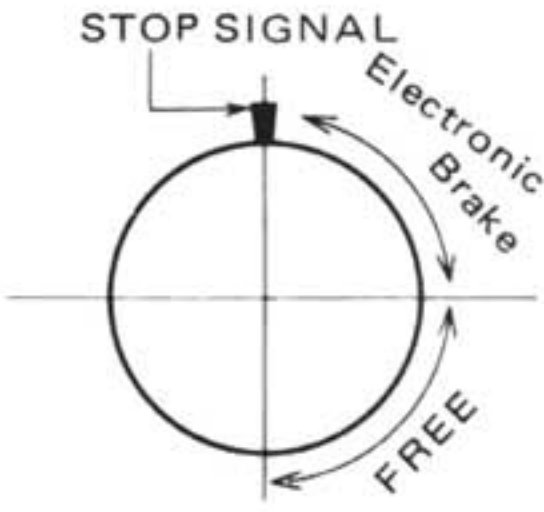
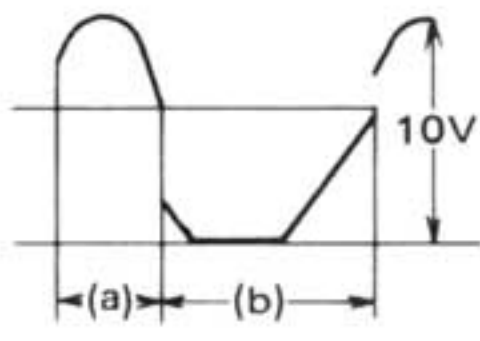
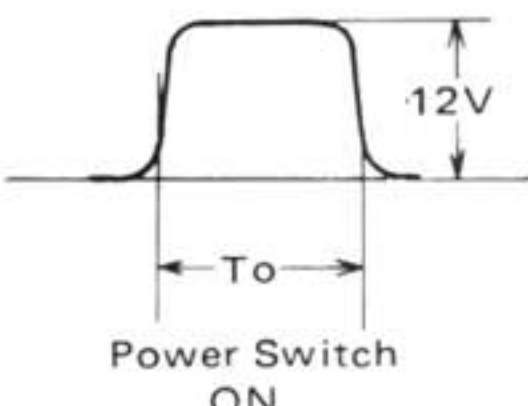

Fig. 21

■ ADJUSTMENTS-3

Adjustment Points of Electrical System

NOTE: Make the following adjustments after replacing parts such as IC's, transistors, diodes, etc.

	Adjustment	Connection Points	Adjustment Point	Adjustment Method
A	Adjustment of standard voltage (VS)	DC voltmeter or Oscilloscope ⊕ → TP15 ⊖ → GRAND	VR201	Turn start switch on to begin turntable rotation. For 33 rpm . . . adjust VR201 for DC 2.10V ±0.05V. For 45 rpm . . . confirm that there is DC 2.80 ~ 2.86V.
B	Adjustment of current source (IR)	DC voltmeter or Oscilloscope ⊕ → TP19 ⊖ → TP21	VR202	Turn start switch on to begin turntable rotation. Adjust VR202 for 0V potential difference of TP19 and TP21.
C	Tracking adjustment	Oscilloscope ⊕ → TP18 ⊖ → GRAND	VR101	TP18 waveform  For 33 rpm . . . adjust VR101 for $8 \leq T_0 \leq 8.5$ ms. For 45 rpm . . . confirm that $5.8 \leq T_0 \leq 6.4$ ms.
D	Braking adjustment	—	VR203	 Adjust VR203 for complete stop within 90° ~ 180° after stop signal initiated. (Turntable becomes free a few seconds after stop.)
E	Optical sensor gain adjustment	Oscilloscope ⊕ → TP32 ⊖ → GRAND	VR501	TP32 waveform  With arm near center spindle, manually move with uniform motion, and adjust VR501 as that the (a) and (b) pitch of the waveform of TP32 is equal.
F	Auto-Return time adjustment	Oscilloscope ⊕ → TP38 ⊖ → GRAND	VR502	TP38 waveform  Turn power switch on, and adjust VR502 so that the time (To) from power on until the voltage of TP38 inverts is 1.5 second at 33 rpm. (1.1 second at 45 rpm) TP37: for 33 rpm . . . 0V for 45 rpm . . . 2V

Schematic Diagram Model SL-1300MK2 (This schematic diagram may be modified at any time with the development of new technology.)

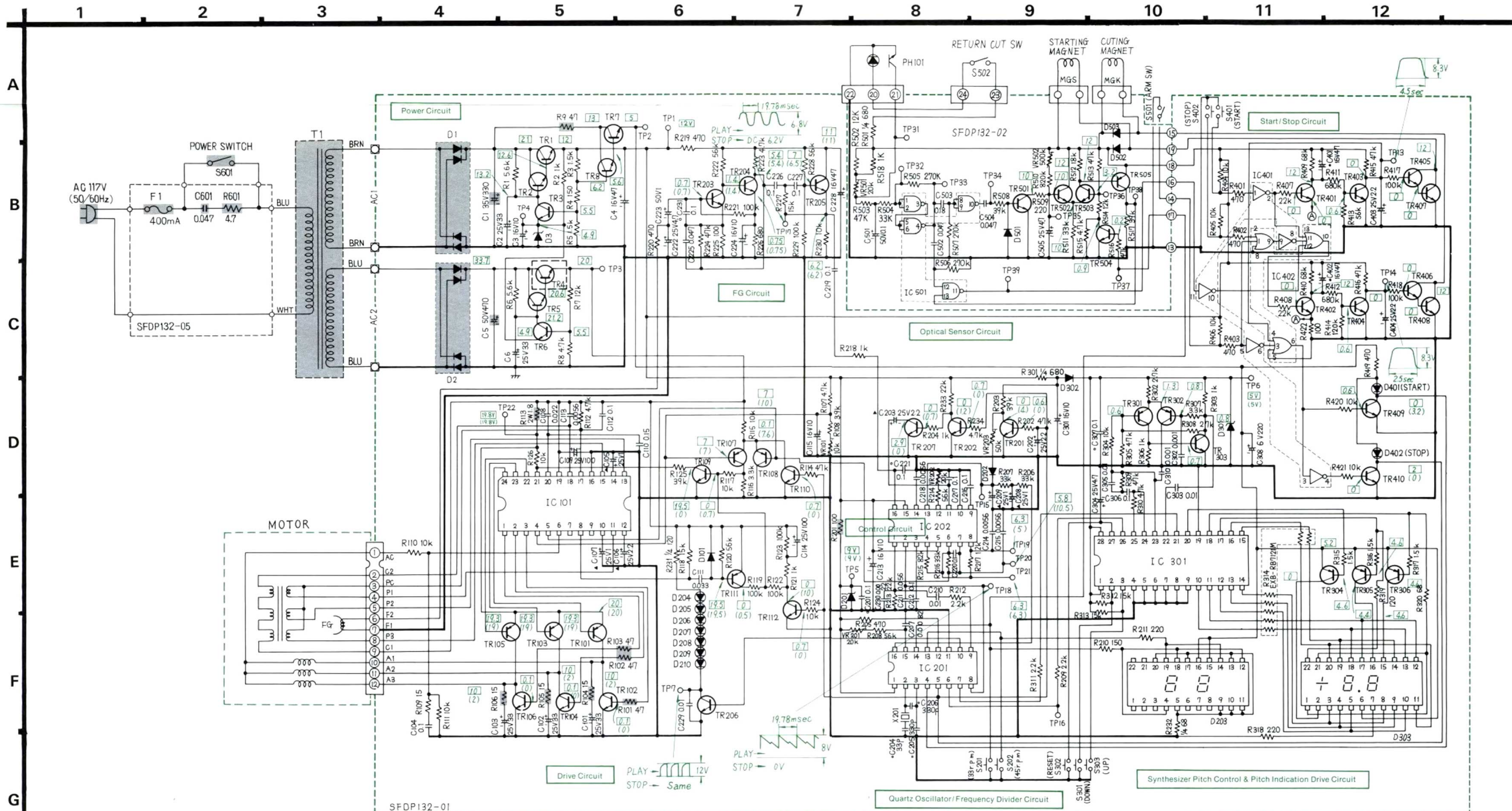

■ TERMINAL GUIDE

①		2SC1826	④		AN640	⑦		SVIMSM4075
②		2SC1383 2SC1384 2SA719 2SA564 2SC828 2SC828A	⑤		DN860	⑧		SVDGL-7R204
③		2SC1406	⑥		MN6042	⑨		SVDGL-7R203

IMPORTANT SAFETY NOTICE
 THE SHADED AREA ON THIS SCHEMATIC DIAGRAM INCORPORATES SPECIAL FEATURES IMPORTANT FOR SAFETY. WHEN SERVICING IT IS ESSENTIAL THAT ONLY MANUFACTURER'S SPECIFIED PARTS BE USED FOR THE CRITICAL COMPONENTS IN THE SHADED AREAS OF THE SCHEMATIC.

- Notes:**
- S201: Speed select switch (33 r.p.m.)
 - S202: Speed select switch (45 r.p.m.)
 - S301: Pitch Control switch (Down)
 - S302: Pitch Control switch (Reset)
 - S303: Pitch Control switch (Up)
 - S401: Start switch in "off" position.
 - S402: Stop switch in "off" position.
 - S501: Arm switch in "off" position.
 - S502: Return cut switch in "off" position.
 - S601: Power switch in "off" position.

11. The voltage values entered are the values measured from the chassis with a standard tester that has an internal resistance of 100KΩ/V.

TR1, 4, 7	2SC1826	IC101	AN640
TR2, 3, 6, 8, 405, 406	2SC1328-T	IC201	DN860
TR5	2SC1384	IC202	AN660
TR102, 104, 106	2SC1406	IC301	MN6042
TR101, 103, 105	2SA752	IC401	SVIMSM4069
TR107, 107, 111	2SA666A1-R	IC402	SVIMSM4075
301, 302, 505		IC501	SVIMSM4011
TR109, 110, 112, 201 ~ 207, 303	2SC1328-T	D1, 2	SVDSIRBA20
401 ~ 404, 409, 410, 501 ~ 504		D3, 301	SVDRD5.1EBS
TR304 ~ 306		D101, 202, 302, 501 ~ 503	MA150
TR407, 408	2SA719	D201	SVDRD9.1EBS
	2SC1384	D203	SVDGL-7R204
		D203 ~ 210	SVDSR105C
		D303	SVDGL-7R203
		D401, 402	SVDSR105C

Printed Circuit Board SL-1300MK2

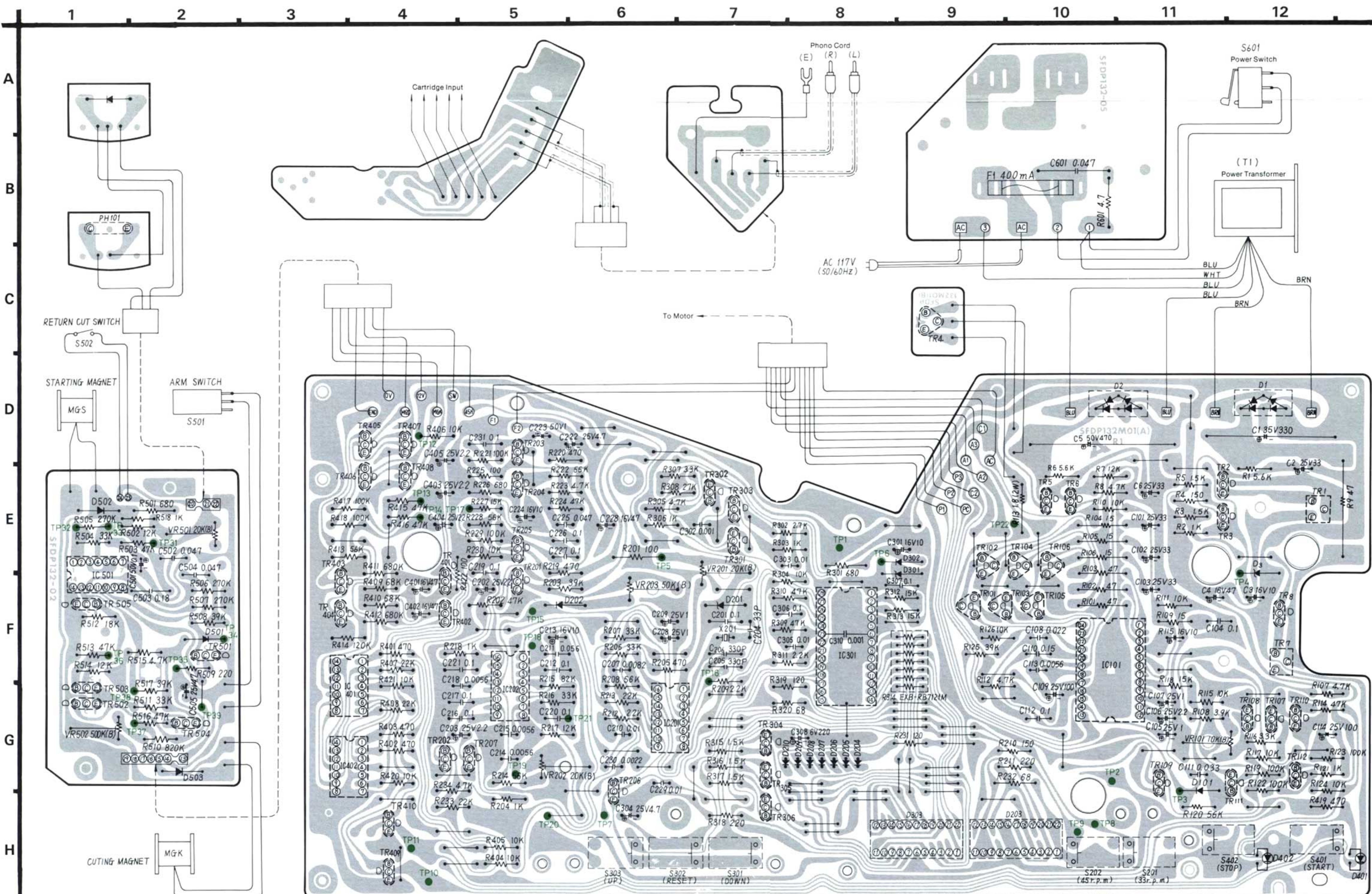

TR1	TR2	TR3	TR4	TR5	TR6	TR7	TR8	TR101	TR102	TR103	TR104	TR105	TR106	TR107	TR108	TR109	TR110	TR111	TR112	TR201	TR202	TR203	TR204		
2SC1826	2SC828A	2SC828A	2SC1826	2SC1383	2SC828A	2SC1826	2SC828A	2SA751	2SC1406	2SA751	2SC1406	2SA751	2SC1406	2SA564	2SA564	2SC828	2SC828	2SA564	2SC828	2SC828	2SC828	2SC828	2SC828	2SC828	
E 12 V	E 12.6 V	E 4.9 V	E 20 V	E 4.9 V	E 4.9 V	E 5 V	E 5.6 V	E 20 V	E 0 V	E 20 V	E 0 V	E 20 V	E 0 V	E 0.1 V	E 0.1 V	E 0 V	E 0 V	E 20 V	E 0 V	E 0 V	E 0 V	E 0 V	E 0.75 V	E 0.75 V	
C 21 V	C 21 V	C 13.2 V	C 33.7 V	C 33.7 V	C 1.2 V	C 1.3 V	C 1.0 V	C 1.0 V	C 1.0 V	C 1.0 V	C 1.0 V	C 1.0 V	C 1.0 V	C 0 V	C 0 V	C 19.5 V	C 0.1 V	C 0 V	C 0 V	C 0 V	C 0 V	C 1.4 V	C 1.4 V	C 1.4 V	
B 12.6 V	B 13.2 V	B 5.5 V	B 20.6 V	B 21.2 V	B 5.5 V	B 5.6 V	B 1.93 V	B 0.7 V	B 0.7 V	B 1.93 V	B 0.7 V	B 0.7 V	B 0.7 V	B 7 V	B 7 V	B 0.7 V	B 0.7 V	B 19.5 V	B 0.7 V	B 0.7 V	B 0.7 V	B 0.7 V	B 0.7 V	B 1.4 V	B 1.4 V
TR205	TR206	TR207	TR301	TR302	TR303	TR304	TR305	TR306	TR401	TR402	TR403	TR404	TR405	TR406	TR407	TR408	TR409	TR410	TR501	TR502	TR503	TR504	TR505		
2SC828	2SC828	2SC828	2SA564	2SA564	2SC828	2SA719	2SA719	2SA719	2SC828	2SC828	2SC828	2SC828	2SC828	2SC828A	2SC828A	2SC1384	2SC1384	2SC828	2SC828	2SC828	2SC828	2SC828	2SA564		
E 6.2 V	E 11 V	E 0 V	E 1.3 V	E 1.3 V	E 0 V	E 5.2 V	E 5.2 V	E 5.2 V	E 0 V	E 0 V	E 0 V	E 0 V	E 0 V	E 0 V	E 0 V	E 0 V	E 0 V	E 0 V	E 0 V	E 10 V	E 10 V	E 0 V	E 0 V		
C 11 V	C 11 V	C 0 V	C 2.4 V	C 0.7 V	C 0.8 V	C 0 V	C 4.4 V	C 4.4 V	C 1.2 V	C 1.2 V	C 1.2 V	C 1.2 V	C 1.2 V	C 1.2 V	C 1.2 V	C 1.2 V	C 0 V	C 0 V	C 0 V	C 0 V	C 0 V	C 0 V	C 0 V		
B 7 V	B 7 V	B 0 V	B 0.6 V	B 0.8 V	B 0.7 V	B 4.6 V	B 4.6 V	B 4.6 V	B 0 V	B 0 V	B 0 V	B 0 V	B 0 V	B 0 V	B 0 V	B 0 V	B 0 V	B 0 V	B 0 V	B 10 V	B 10 V	B 0.2 V	B 0.2 V		

■ BLOCK DIAGRAM

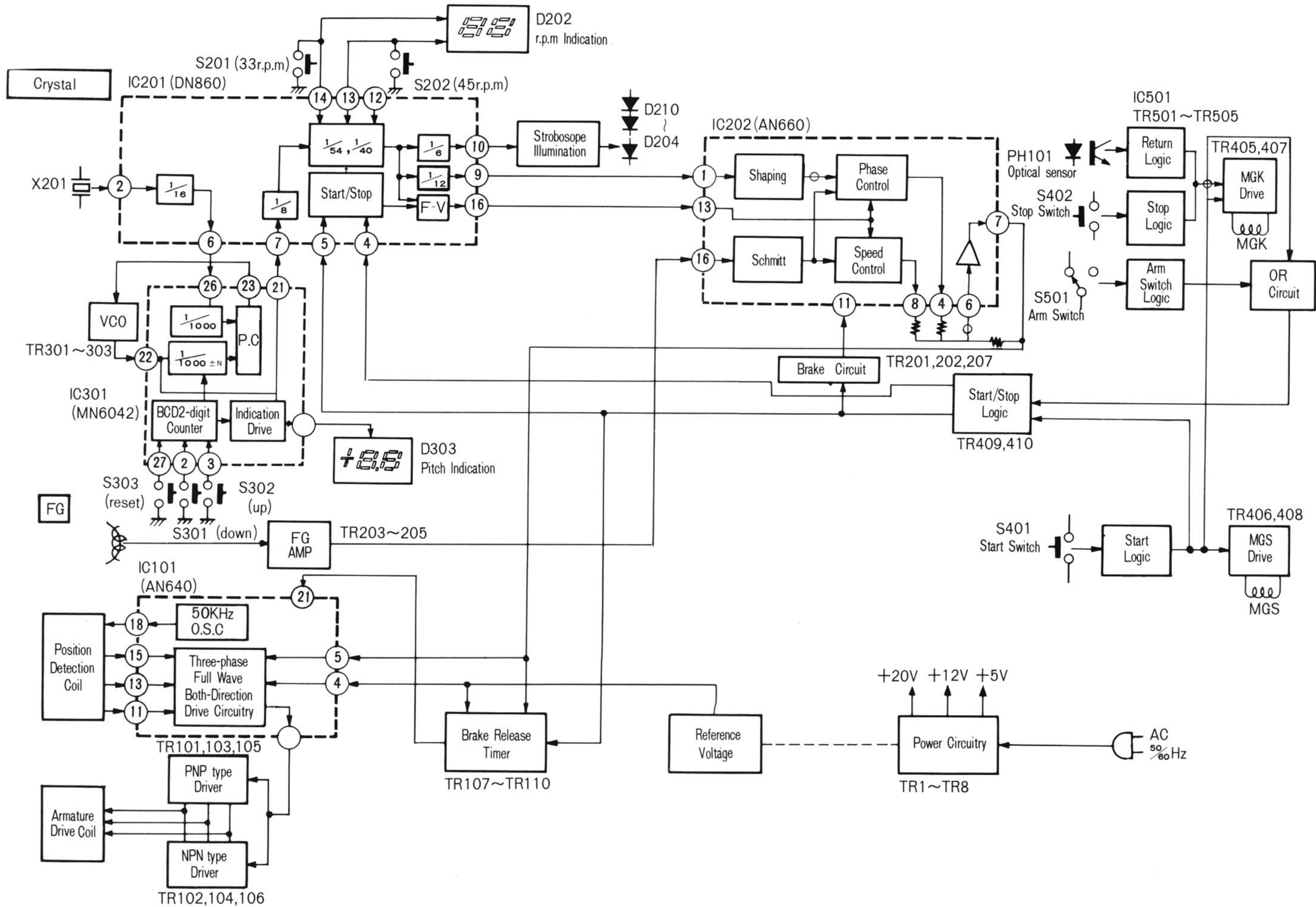

■ TROUBLE SHOOTING

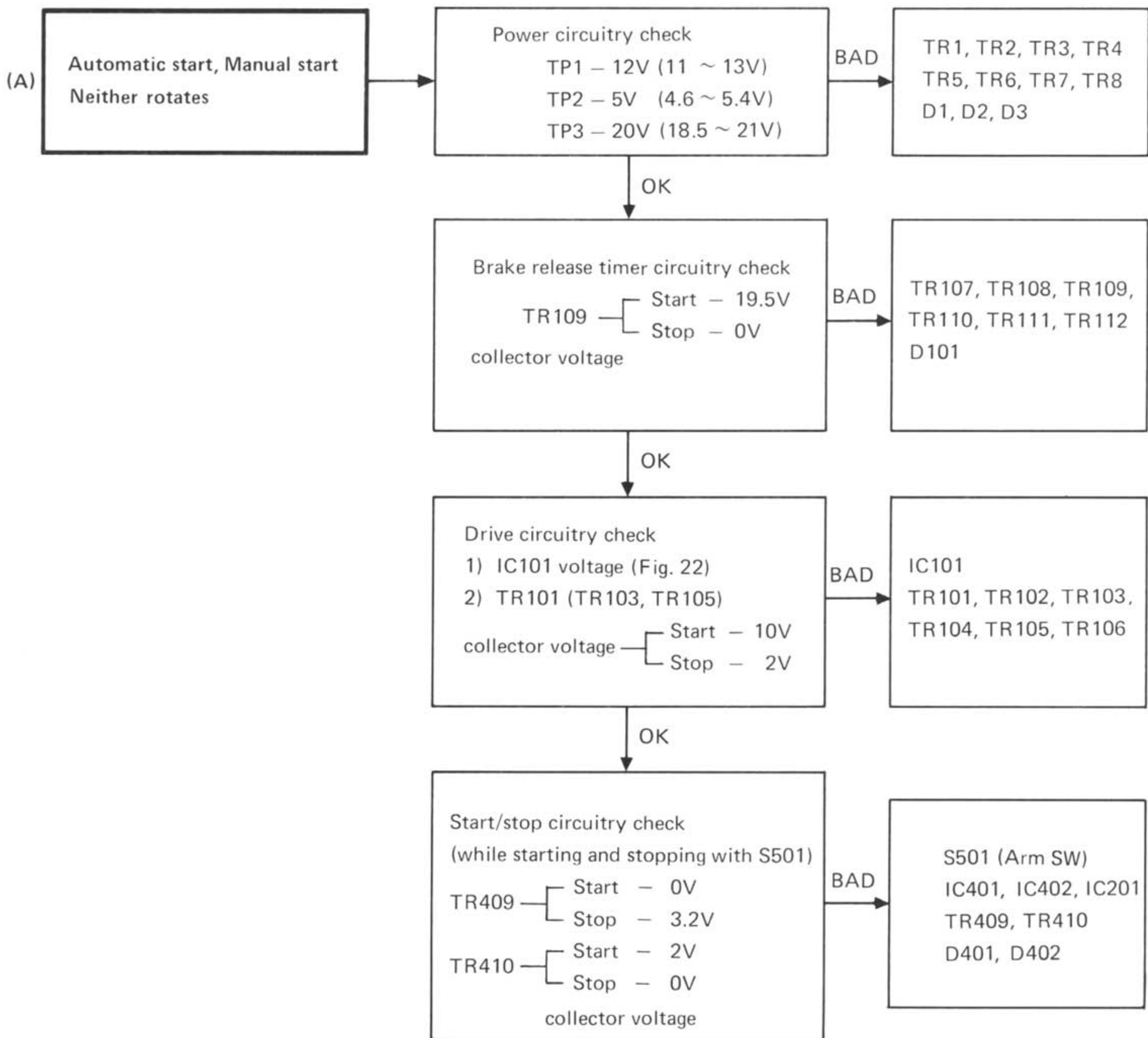

Reference voltage of each pin of IC101

(Fig. 22)

	Start	Stop		Start	Stop		Start	Stop	
①		0.1V	⑩		15.2V	⑰	15.5V	15.5V	
②					Same as at left	⑱		Same as at left	
③						⑪	14.5V		⑲
④	5.8V	6.1V	⑬		15V	⑳	15.3V	1.4V	
⑤	5.9V	10.5V	⑮			⑫	4.9V	4.9V	㉑
⑥	4.7V	2.2V	⑭		15V	㉒	20V	20V	
⑦	4.9V	4.9V				⑯			14.9V
⑧	20.5V	20.5V	⑰	0V	0V	㉔			
⑨		0.2V	⑱	0V	0V				

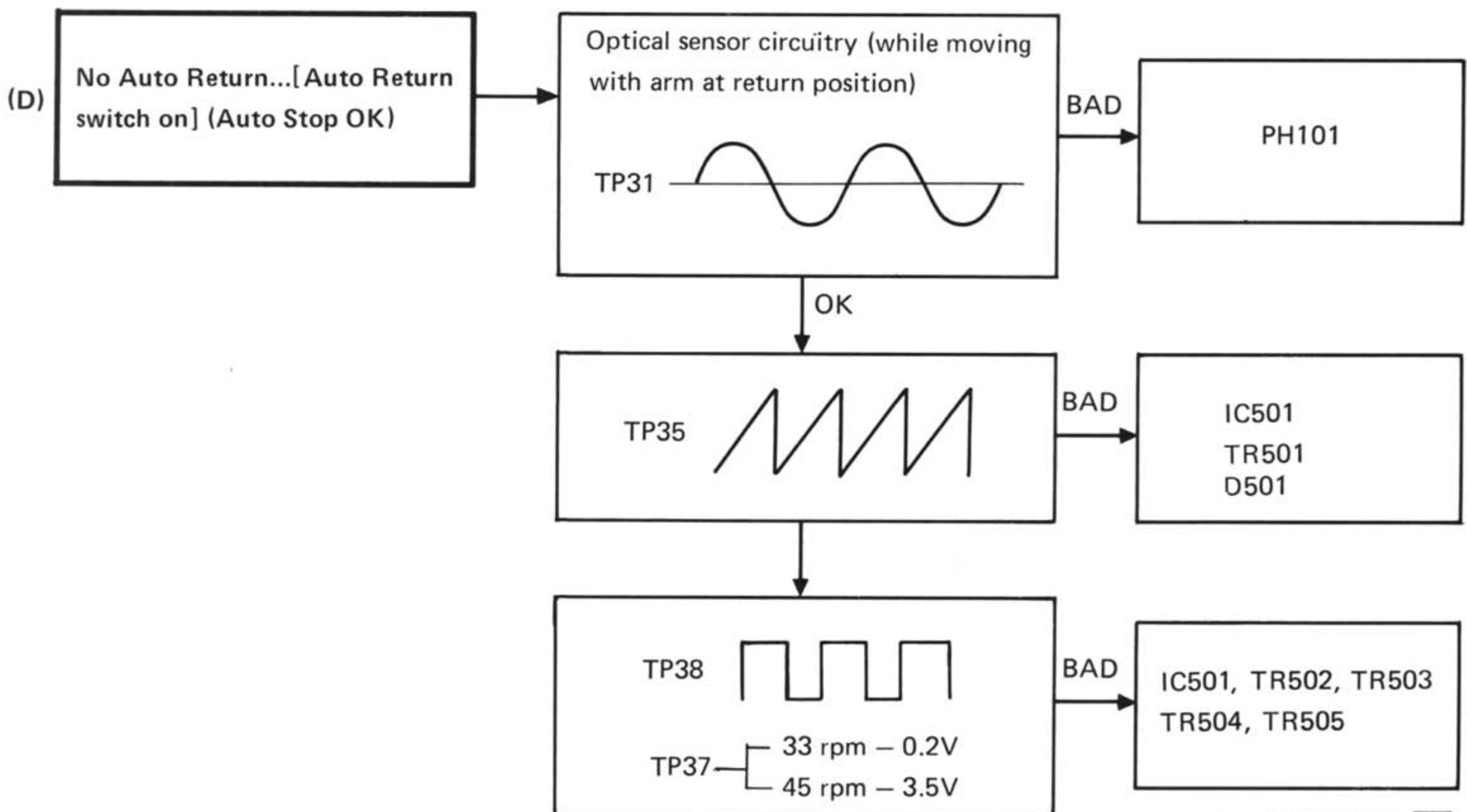
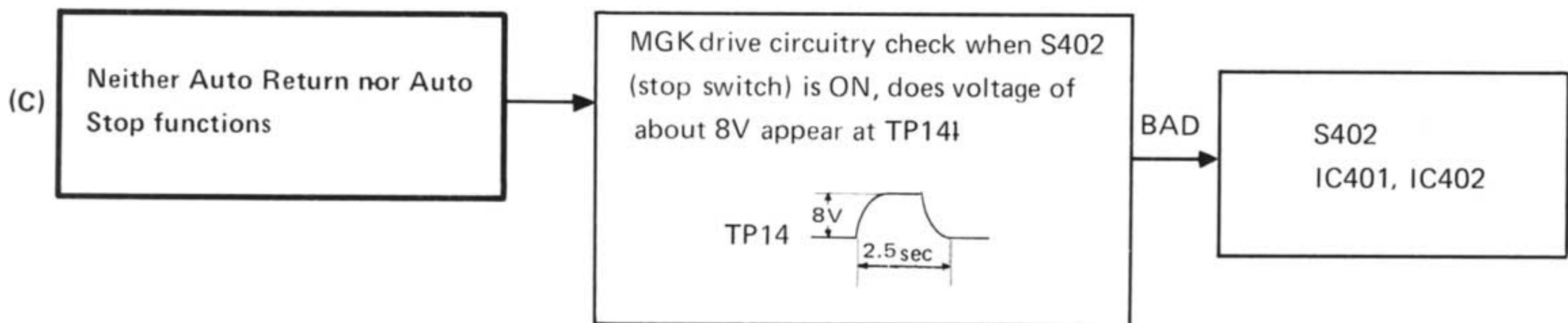
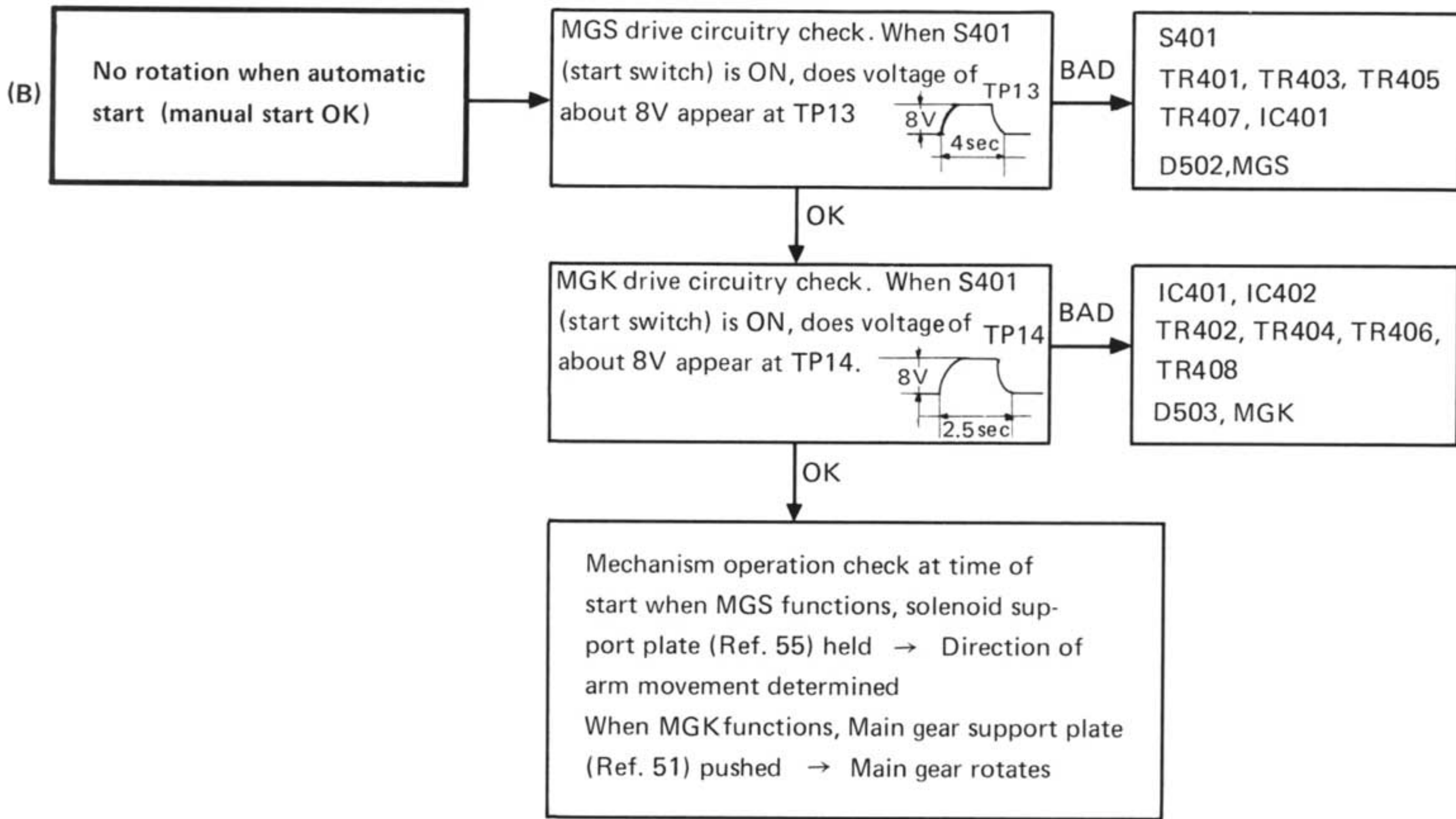

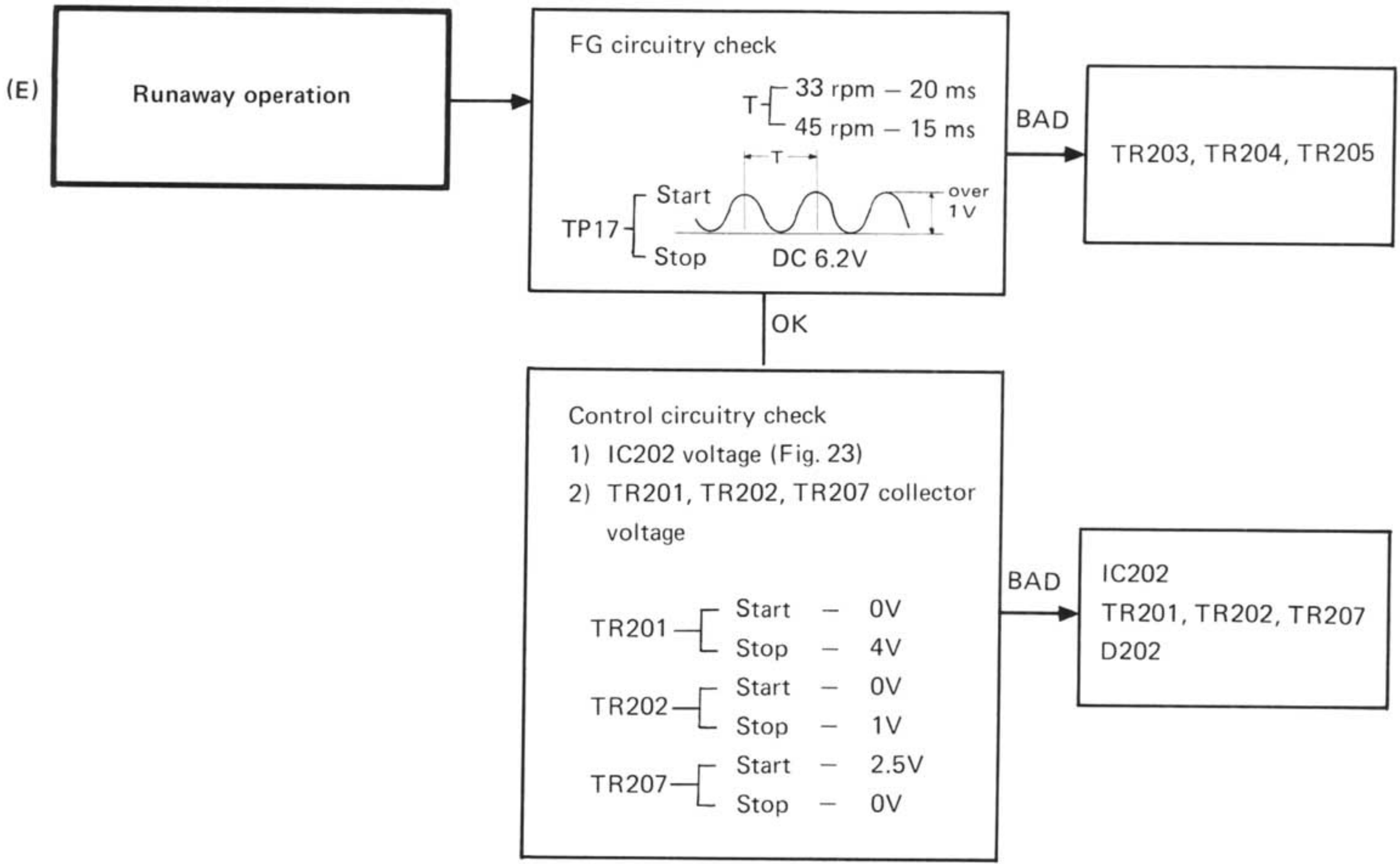

Reference voltage of each pin of IC202
(Fig. 23)

	Start	Stop		Start	Stop		Start	Stop
①		0 V	⑥	6.3V	6.3V	⑫	2.1V	2.7V
②	Same at TP18	0 V	⑦	5.8V	10.5V	⑬	2.1V	2.7V
③		6.1V	⑧	6.3V	5.0V	⑭		7.5V
④	6.6V	6.2V	⑨		7.1V	⑮	11.7V	11.7V
⑤	11.7V	11.7V	⑩	0 V	0 V	⑯		5.5V
			⑪		7.5V	⑰		

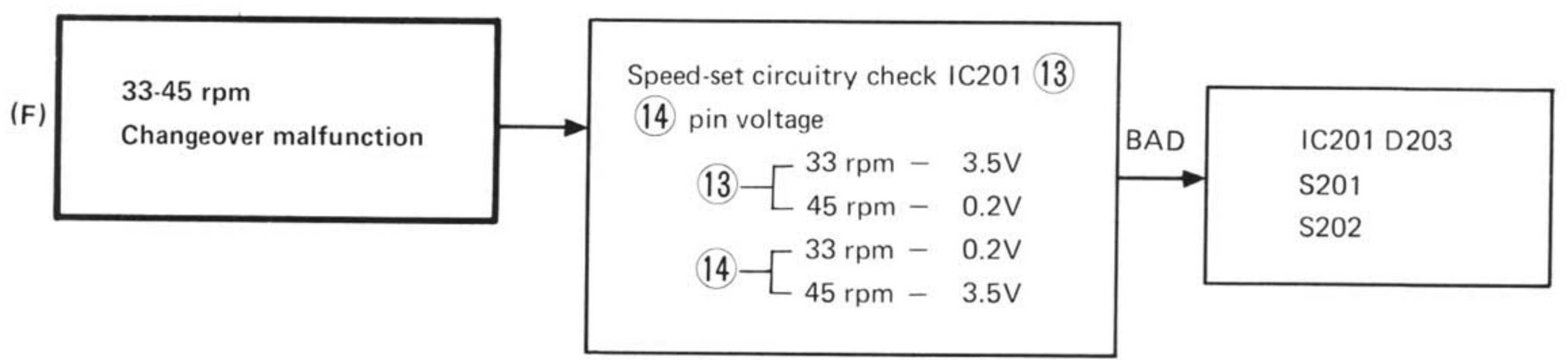



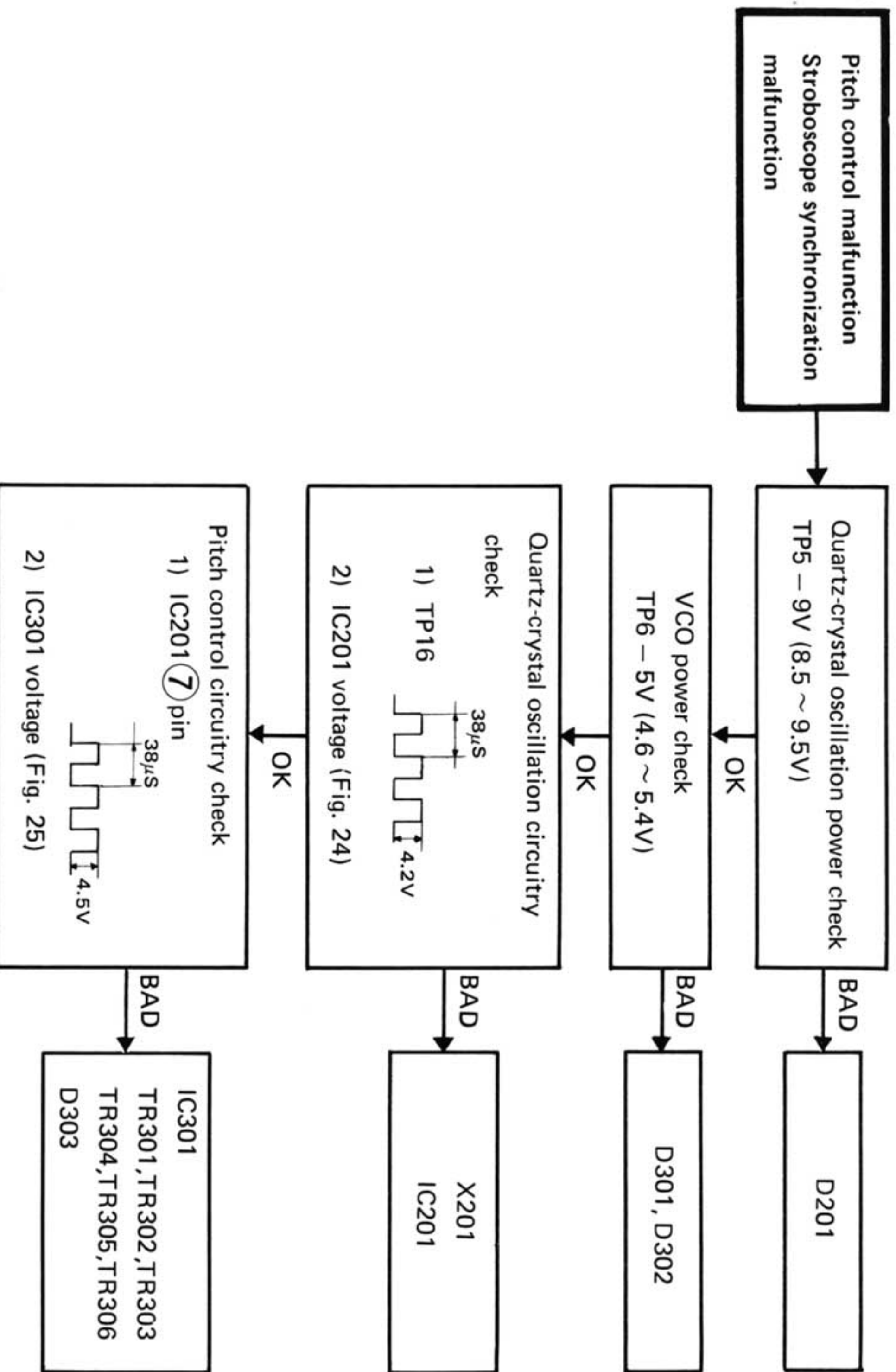





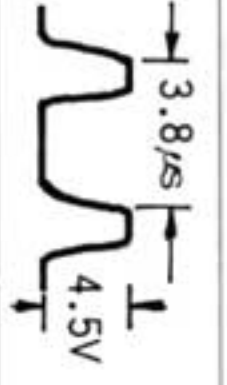
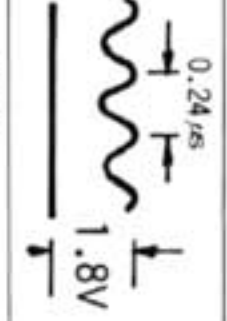
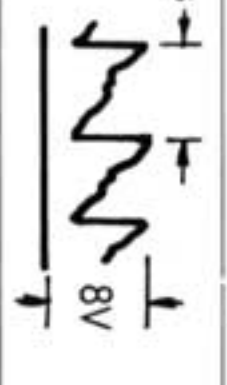
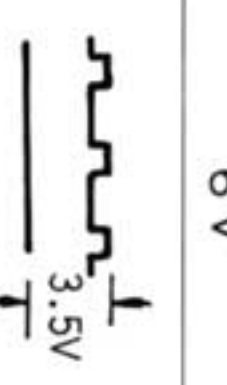
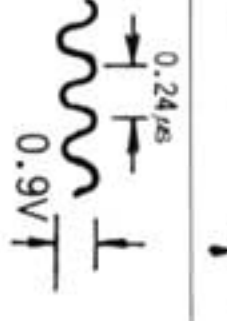
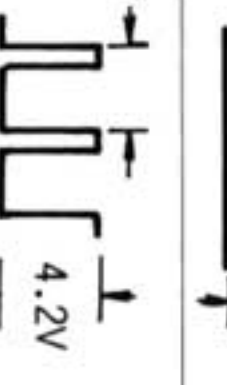
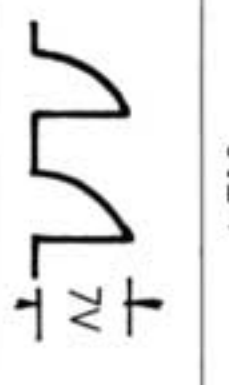

(G)

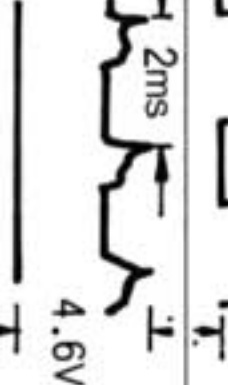
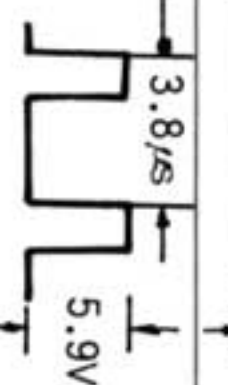

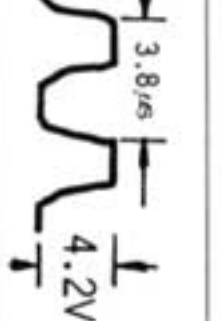

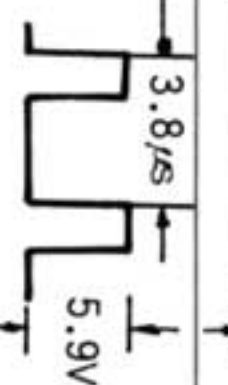
Reference voltage of each pin of IC201

(Fig. 24)

1	Start	9.4V	Stop	9.4V	7	Start		Stop	Same as at left	11	Start	0V	Stop	0V	12	Start	6V	Stop	6V
2	Start		Stop	Same as at left	8	Start		Stop	0V	13	Start		Stop	Same as at left	14	Start	0.2V	Stop	0.2V
3	Start		Stop	Same as at left	9	Start		Stop	4.3V	15	Start		Stop	Same as at left	16	Start		Stop	0V
4	Start	0V	Stop	3.2V	10	Start		Stop	Same as at left	17	Start		Stop	Same as at left	18	Start		Stop	Same as at left
5	Start	2.0V	Stop	0V	11	Start		Stop	Same as at left	19	Start		Stop	Same as at left	20	Start		Stop	Same as at left
6	Start		Stop	Same as at left	12	Start		Stop	Same as at left	21	Start		Stop	Same as at left	22	Start		Stop	Same as at left

Reference voltage of each pin of IC301

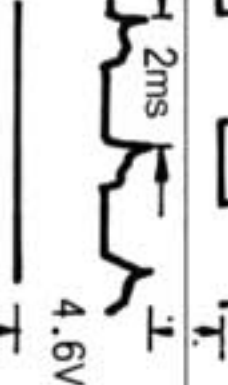
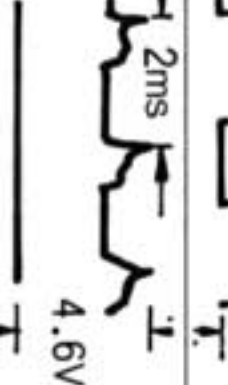
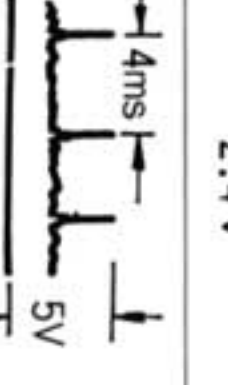
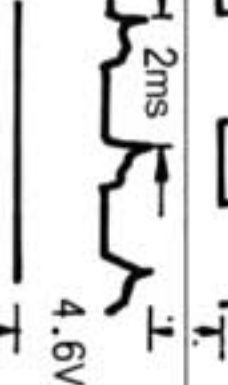
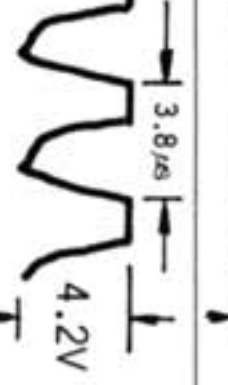
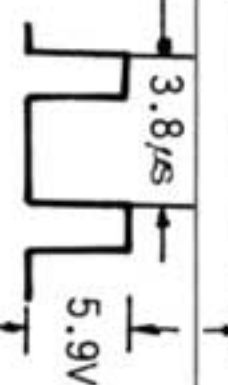
(Fig. 25)

1	Start	4.9V	Stop	4.9V	17	Start		Stop	Same as at left	23	Start	2.4V	Stop	Same as at left
2	Start	4.9V	Stop	4.9V	18	Start		Stop	Same as at left	24	Start	2.4V	Stop	Same as at left
3	Start	0V	Stop	0V	19	Start		Stop	Same as at left	25	Start		Stop	Same as at left
4	Start	0V	Stop	0V	20	Start		Stop	Same as at left	26	Start		Stop	Same as at left
5	Start	0V	Stop	0V	21	Start		Stop	Same as at left	27	Start	5V	Stop	5V
6	Start	0V	Stop	0V	22	Start		Stop	Same as at left	28	Start	5V	Stop	5V

REPLACEMENT PARTS LIST

Important Safety Notice

Components identified by shaded area have special characteristics important for safety. When replacing any of these components use only manufacturer's specified parts.

NOTE: 1. Part numbers are indicated on most mechanical parts.
Please use this part number for parts orders.

Ref. No.	Part No.	Part Name & Description	Per Set	Remarks
INTEGRATED CIRCUITS				
IC101	AN640	Drive Circuit	1	
IC201	DN860	Frequency Divider Circuit	1	○
IC202	AN660	Control Circuit	1	○
IC301	MN6042	Pitch Control Circuit	1	○
IC401	SVIMSM4069	Start & Stop Logic Circuit (NOT)	1	○
IC402	SVIMSM4075	Start & Stop Logic Circuit (OR)	1	○
IC501	SVIMSM4011	Optical Censor Return Pulse Circuit (NAND)	1	○
TRANSISTORS				
TR1, 4, 7	2SC1826-Y	Transistors (Use in ranks O or Y or G)	3	○
TR2, 3, 6, 8, 405, 406	2SC1328-T	Transistors	6	
TR5	2SC1384A-Q	Transistor (Use in ranks Q or R or S)	1	
TR101	2SA752-Q	Transistor (Use in pair ranks Q or R or S)	1	
TR102	2SC1406-Q	Transistor (Use in pair ranks Q or R or S)	1	
TR103	2SA752-Q	Transistor (Use in pair ranks Q or R or S)	1	
TR104	2SC1406-Q	Transistor (Use in pair ranks Q or R or S)	1	
TR105	2SA752-Q	Transistor (Use in pair ranks Q or R or S)	1	
TR106	2SC1406-Q	Transistor (Use in pair ranks Q or R or S)	1	
TR107, 108, 111, 301, 302, 505	2SA666AI-R	Transistor (Use in ranks Q or R or S)	6	
TR109, 110, 112, 201, 202, 203, 204, 205, 206, 207, 303, 401, 402, 403, 404, 409, 410, 501, 502, 503, 504	2SC1328-T	Transistor	21	
TR304, 305, 306	2SA719-P	Transistors (Use in ranks P or Q or R or S)	3	○
TR407, 408	2SC1384-Q	Transistors (Use in ranks Q or R or S)	2	
DIODES				
D1, 2	SVDSIRBA20	Rectifier	2	○
D3, 301	SVDRD5.1EBS	5.1V Zener, Voltage Stabilizer	2	○
D101, 202, 302, 501, 502, 503	MA150	Diodes	6	
D201	SVDRD9.1EBS	9.1V Zener, Voltage Stabilizer	1	
D203	SVDGL-7R204	Light Emitting Diode (r.p.m)	1	○
D204, 205, 206, 207, 208, 209, 210, 401, 402	SVDSR105C	Light Emitting Diode	9	○
D303	SVDGL-7R203	Light Emitting Diode (pitch)	1	○
CRYSTAL				
X204	SVQU306115	4.19328MHz Oscillator	1	○
TRANSFORMER				
T1	SLT60EU3B	Power Transformer	1	○
FUSE				
F1	XBA2F04NU100	400mA (Fuse)	1	○

Ref. No.	Part No.	Part Name & Description	Per Set	Remarks
SWITCHES				
S201, 202	EVQP4R04K	Speed Selector Switches	2	○
S301, 302, 303	EVQP4R04K	Pitch Control Switches	3	○
S401, 402	EVQP4R04K	Start or Stop Switches	2	○
S501	SFDSA73502	Arm Switch	1	
S502	ESB6015	Return Cut Switch	1	○
S601	SFDSS5GL2	Power Switch	1	
	SFDSSW0634	Muting Switch, Tone Arm	1	○
RESISTORS				
R1	ERD25TJ562	Carbon, 5.6k Ω , 1/4W, \pm 5%	1	
R2	ERD25TJ102	Carbon, 1k Ω , 1/4W, \pm 5%	1	
R3	ERD25TJ152	Carbon, 1.5k Ω , 1/4W, \pm 5%	1	
R4	ERD25TJ151	Carbon, 150 Ω , 1/4W, \pm 5%	1	
R5	ERD25TJ152	Carbon, 1.5k Ω , 1/4W, \pm 5%	1	
R6	ERD25TJ562	Carbon, 5.6k Ω , 1/4W, \pm 5%	1	
R7	ERD25TJ123	Carbon, 12k Ω , 1/4W, \pm 5%	1	
R8	ERD25TJ472	Carbon, 4.7k Ω , 1/4W, \pm 5%	1	
R9	ERG3ANJ470	Metal Film, 47 Ω , 3W, \pm 5%	1	
R101, 102, 103	ERX1ANJ470	Metal Film, 47 Ω , 1W, \pm 5%	3	
R104, 105, 106	ERX1ANJ150	Metal Film, 15 Ω , 1W, \pm 5%	3	
R107	ERD25TJ472	Carbon, 4.7k Ω , 1/4W, \pm 5%	1	
R108	ERD25TJ392	Carbon, 3.9k Ω , 1/4W, \pm 5%	1	
R109	ERD25TJ150	Carbon, 15 Ω , 1/4W, \pm 5%	1	
R110, 111	ERD25TJ103	Carbon, 10k Ω , 1/4W, \pm 5%	2	
R112	ERD25TJ472	Carbon, 4.7k Ω , 1/4W, \pm 5%	1	
R113	ERX1ANJ1R8	Metal Film, 1.8 Ω , 1W, \pm 5%	1	
R114	ERD25TJ473	Carbon, 47k Ω , 1/4W, \pm 5%	1	
R115	ERD25TJ103	Carbon, 10k Ω , 1/4W, \pm 5%	1	
R116	ERD25TJ332	Carbon, 3.3k Ω , 1/4W, \pm 5%	1	
R117	ERD25TJ103	Carbon, 10k Ω , 1/4W, \pm 5%	1	
R118	ERD25TJ153	Carbon, 15k Ω , 1/4W, \pm 5%	1	
R119	ERD25TJ104	Carbon, 100k Ω , 1/4W, \pm 5%	1	
R120	ERD25TJ563	Carbon, 56k Ω , 1/4W, \pm 5%	1	
R121	ERD25TJ102	Carbon, 1k Ω , 1/4W, \pm 5%	1	
R122, 123	ERD25TJ104	Carbon, 100k Ω , 1/4W, \pm 5%	2	
R124	ERD25TJ103	Carbon, 10k Ω , 1/4W, \pm 5%	1	
R125	ERD25TJ393	Carbon, 39k Ω , 1/4W, \pm 5%	1	
R126	ERD25TJ103	Carbon, 10k Ω , 1/4W, \pm 5%	1	
R201	ERX1ANJ101	Metal Film, 100 Ω , 1W, \pm 5%	1	
R202	ERD25TJ473	Carbon, 47k Ω , 1/4W, \pm 5%	1	
R203	ERD25TJ393	Carbon, 39k Ω , 1/4W, \pm 5%	1	
R204	ERD25TJ102	Carbon, 1k Ω , 1/4W, \pm 5%	1	
R205	ERD25TJ471	Carbon, 470 Ω , 1/4W, \pm 5%	1	
R206, 207	ERD25TJ333	Carbon, 33k Ω , 1/4W, \pm 5%	2	
R208	ERD25TJ563	Carbon, 56k Ω , 1/4W, \pm 5%	1	
R209	ERD25TJ222	Carbon, 2.2k Ω , 1/4W, \pm 5%	1	
R210	ERD25TJ151	Carbon, 150 Ω , 1/4W, \pm 5%	1	
R211	ERD25TJ221	Carbon, 220 Ω , 1/4W, \pm 5%	1	
R212	ERD25TJ222	Carbon, 2.2k Ω , 1/4W, \pm 5%	1	
R213	ERD25TJ223	Carbon, 22k Ω , 1/4W, \pm 5%	1	
R214	ERD25TJ563	Carbon, 56k Ω , 1/4W, \pm 5%	1	
R215	ERD25TJ823	Carbon, 82k Ω , 1/4W, \pm 5%	1	
R216	ERD25TJ333	Carbon, 33k Ω , 1/4W, \pm 5%	1	
R217	ERD25TJ123	Carbon, 12k Ω , 1/4W, \pm 5%	1	
R218	ERD25TJ102	Carbon, 1k Ω , 1/4W, \pm 5%	1	
R219, 220	ERD25TJ471	Carbon, 470 Ω , 1/4W, \pm 5%	2	
R221	ERD25TJ104	Carbon, 100k Ω , 1/4W, \pm 5%	1	
R222	ERD25TJ563	Carbon, 56k Ω , 1/4W, \pm 5%	1	
R223	ERD25TJ472	Carbon, 4.7k Ω , 1/4W, \pm 5%	1	

Ref. No.	Part No.	Part Name & Description	Per Set	Remarks
R224	ERD25TJ473	Carbon, 47k Ω , 1/4W, \pm 5%	1	
R225	ERD25TJ101	Carbon, 100 Ω , 1/4W, \pm 5%	1	
R226	ERD25TJ681	Carbon, 680 Ω , 1/4W, \pm 5%	1	
R227	ERD25TJ153	Carbon, 15k Ω , 1/4W, \pm 5%	1	
R228	ERD25TJ563	Carbon, 56k Ω , 1/4W, \pm 5%	1	
R229	ERD25TJ104	Carbon, 100k Ω , 1/4W, \pm 5%	1	
R230	ERD25TJ103	Carbon, 10k Ω , 1/4W, \pm 5%	1	
R231	ERD25TJ121	Carbon, 120 Ω , 1/4W, \pm 5%	1	
R232	ERD25TJ680	Carbon, 68 Ω , 1/4W, \pm 5%	1	
R233	ERD25TJ223	Carbon, 22k Ω , 1/4W, \pm 5%	1	
R234	ERD25TJ472	Carbon, 4.7k Ω , 1/4W, \pm 5%	1	
R301	ERD25TJ391	Carbon, 390 Ω , 1/4W, \pm 5%	1	
R302	ERD25TJ272	Carbon, 2.7k Ω , 1/4W, \pm 5%	1	
R303	ERD25TJ102	Carbon, 1k Ω , 1/4W, \pm 5%	1	
R304	ERD25TJ103	Carbon, 10k Ω , 1/4W, \pm 5%	1	
R305	ERD25TJ472	Carbon, 4.7k Ω , 1/4W, \pm 5%	1	
R306	ERD25TJ102	Carbon, 1k Ω , 1/4W, \pm 5%	1	
R307	ERD25TJ332	Carbon, 3.3k Ω , 1/4W, \pm 5%	1	
R308	ERD25TJ273	Carbon, 27k Ω , 1/4W, \pm 5%	1	
R309, 310	ERD25TJ473	Carbon, 47k Ω , 1/4W, \pm 5%	2	
R311	ERD25TJ222	Carbon, 2.2k Ω , 1/4W, \pm 5%	1	
R312, 313	ERD25TJ153	Carbon, 15k Ω , 1/4W, \pm 5%	2	
R314	EXBRB7121M	Composite Resistor, 120 Ω , x 7, \pm 20%	1	○
R315, 316, 317	ERD25TJ152	Carbon, 1.5k Ω , 1/4W, \pm 5%	3	
R318	ERD25TJ221	Carbon, 220 Ω , 1/4W, \pm 5%	1	
R319	ERD25TJ121	Carbon, 120 Ω , 1/4W, \pm 5%	1	
R320	ERD25TJ680	Carbon, 68 Ω , 1/4W, \pm 5%	1	
R401, 402, 403	ERD25TJ471	Carbon, 470 Ω , 1/4W, \pm 5%	3	
R404, 405, 406	ERD25TJ103	Carbon, 10k Ω , 1/4W, \pm 5%	3	
R407, 408	ERD25TJ223	Carbon, 22k Ω , 1/4W, \pm 5%	2	
R409, 410	ERD25TJ683	Carbon, 68k Ω , 1/4W, \pm 5%	2	
R411, 412	ERD25TJ684	Carbon, 680k Ω , 1/4W, \pm 5%	2	
R413	ERD25TJ563	Carbon, 56k Ω , 1/4W, \pm 5%	1	
R414	ERD25TJ124	Carbon, 120k Ω , 1/4W, \pm 5%	1	
R415, 416	ERD25TJ473	Carbon, 47k Ω , 1/4W, \pm 5%	2	
R417, 418	ERD25TJ104	Carbon, 100k Ω , 1/4W, \pm 5%	2	
R419	ERD25TJ471	Carbon, 470 Ω , 1/4W, \pm 5%	1	
R420, 421	ERD25TJ103	Carbon, 10k Ω , 1/4W, \pm 5%	2	
R422	ERD25TJ104	Carbon, 100k Ω , 1/4W, \pm 5%	1	
R501	ERD50TJ681	Carbon, 680 Ω , 1/2W, \pm 5%	1	
R502	ERD25TJ123	Carbon, 12k Ω , 1/4W, \pm 5%	1	
R503	ERD25TJ473	Carbon, 47k Ω , 1/4W, \pm 5%	1	
R504	ERD25TJ333	Carbon, 33k Ω , 1/4W, \pm 5%	1	
R505	ERD25TJ274	Carbon, 270k Ω , 1/4W, \pm 5%	1	
R506, 507	ERD25TJ274	Carbon, 270k Ω , 1/4W, \pm 5%	2	
R508	ERD25TJ393	Carbon, 39k Ω , 1/4W, \pm 5%	1	
R509	ERD25TJ221	Carbon, 220 Ω , 1/4W, \pm 5%	1	
R510	ERD25TJ824	Carbon, 820k Ω , 1/4W, \pm 5%	1	
R511	ERD25TJ333	Carbon, 33k Ω , 1/4W, \pm 5%	1	
R512	ERD25TJ183	Carbon, 18k Ω , 1/4W, \pm 5%	1	
R513	ERD25TJ473	Carbon, 47k Ω , 1/4W, \pm 5%	1	
R514	ERD25TJ123	Carbon, 12k Ω , 1/4W, \pm 5%	1	
R515	ERD25TJ472	Carbon, 4.7k Ω , 1/4W, \pm 5%	1	
R516	ERD25TJ473	Carbon, 47k Ω , 1/4W, \pm 5%	1	
R517	ERD25TJ393	Carbon, 39k Ω , 1/4W, \pm 5%	1	
R518	ERD25TJ102	Carbon, 1k Ω , 1/4W, \pm 5%	1	
R601	ERD50TJ4R7	Carbon, 4.7 Ω , 1/2W, \pm 5%	1	

Ref. No.	Part No.	Part Name & Description	Per Set	Remarks
VARIABLE RESISTORS				
VR101	EVLS3AA00B14	Period Adjustment	1	○
VR201	EVLS3AA00B24	VS Adjustment	1	
VR202	EVLS3AA00B24	IR Adjustment	1	
VR203	EVLS3AA00B54	Brake Adjustment	1	○
VR501	EVLS3AA00B24	Gain Adjustment	1	○
VR502	EVLS3AA00B55	Time Adjustment	1	○
CAPACITORS				
C1	ECEB35V330	Electrolytic, 330 μ F, 35V	1	
C2	ECEA25V33	Electrolytic, 33 μ F, 25V	1	
C3	ECEA16V10	Electrolytic, 10 μ F, 16V	1	
C4	ECEA16V47	Electrolytic, 47 μ F, 16V	1	
C5	ECEB50V470	Electrolytic, 470 μ F, 50V	1	
C6	ECEA25V33	Electrolytic, 33 μ F, 25V	1	
C101, 102, 103	ECEA25V33	Electrolytic, 33 μ F, 25V	3	
C104	ECQM1H104KZ	Polyester, 0.1 μ F, 50V, \pm 10%	1	
C105	ECSZ25EF1	Electrolytic, 1 μ F, 25V	1	
C106	ECSZ25EF2R2	Electrolytic, 2.2 μ F, 25V	1	
C107	ECSZ25EF1	Electrolytic, 1 μ F, 25V	1	
C108	ECQM1H223KZ	Polyester, 0.022 μ F, 50V, \pm 10%	1	
C109	ECEA25Z100	Electrolytic, 100 μ F, 25V	1	
C110	ECQM05154KZ	Polyester, 0.15 μ F, 50V, \pm 10%	1	
C111	ECQM1H333KZ	Polyester, 0.033 μ F, 50V, \pm 10%	1	
C112	ECQM1H104KZ	Polyester, 0.1 μ F, 50V, \pm 10%	1	
C113	ECQM1H562KZ	Polyester, 0.0056 μ F, 50V, \pm 10%	1	
C114	ECEA25V100	Electrolytic, 100 μ F, 25V	1	
C115	ECEA16V10	Electrolytic, 10 μ F, 16V	1	
C201	ECKD1E104ZFZ	Ceramic, 0.1 μ F, 50V,	1	
C202	ECEA25V2R2	Electrolytic, 2.2 μ F, 25V	1	
C203	ECSZ25EF2R2	Electrolytic, 2.2 μ F, 25V	1	
C204	ECCD1H330K	Ceramic, 33pF, 50V, \pm 10%	1	
C205, 206	ECCD1H331K	Ceramic, 330pF, 50V, \pm 10%	2	
C207	ECQM1H822KZ	Polyester, 0.0082 μ F, 50V, \pm 10%	1	
C208, 209	ECSZ25EF1	Electrolytic, 1 μ F, 25V	2	
C210	ECQM1H103KZ	Polyester, 0.01 μ F, 50V, \pm 10%	1	
C211	ECQM1H563KZ	Polyester, 0.056 μ F, 50V, \pm 10%	1	
C212	ECQM1H104KZ	Polyester, 0.1 μ F, 50V, \pm 10%	1	
C213	ECEA16V10	Electrolytic, 10 μ F, 16V	1	
C214	ECQM1H562KZ	Polyester, 0.0056 μ F, 50V, \pm 10%	1	
C215	ECQM1H562KZ	Polyester, 0.0056 μ F, 50V, \pm 10%	1	
C216, 217	ECQM1H104KZ	Polyester, 0.1 μ F, 50V, \pm 10%	2	
C218	ECQM1H562KZ	Polyester, 0.0056 μ F, 50V, \pm 10%	1	
C219, 220	ECQM1H104KZ	Polyester, 0.1 μ F, 50V, \pm 10%	2	
C221	ECKD1E104ZFZ	Ceramic, 0.1 μ F, 50V,	1	
C222	ECEA50V4R7	Electrolytic, 4.7 μ F, 50V	1	
C223	ECEA50V1	Electrolytic, 1 μ F, 50V	1	
C224	ECEA16V10	Electrolytic, 10 μ F, 16V	1	
C225	ECQM1H473KZ	Polyester, 0.047 μ F, 50V, \pm 10%	1	
C226, 227	ECQM1H104KZ	Polyester, 0.1 μ F, 50V, \pm 10%	2	
C228	ECEA16V47	Electrolytic, 47 μ F, 16V	1	
C229	ECQM1H103KZ	Polyester, 0.01 μ F, 50V, \pm 10%	1	
C230	ECQM1H102KZ	Polyester, 0.001 μ F, 50V, \pm 10%	1	
C231	ECKD1E104ZFZ	Ceramic, 0.1 μ F, 50V,	1	
C301	ECEA16V10	Electrolytic, 10 μ F, 16V	1	
C302	ECQM1H102KZ	Polyester, 0.001 μ F, 50V, \pm 10%	1	
C303	ECQM1H103KZ	Polyester, 0.01 μ F, 50V, \pm 10%	1	

Ref. No.	Part No.	Part Name & Description	Per Set	Remarks	Ref. No.	Part No.	Part Name & Description	Per Set	Remarks
C304	ECEA50V4R7	Electrolytic, 4.7 μ F, 50V	1		24	SFUM132-14	Lever, Select Cam	1	○
C305	ECQM1H103KZ	Polyester, 0.01 μ F, 50V, \pm 10%	1		25	SFUP132-05	Plate, Operation Support	1	○
C306	ECQM1H104KZ	Polyester, 0.1 μ F, 50V, \pm 10%	1		26	SFUM132-11	Cam, Repeat	1	○
C307	ECKD1E104ZFZ	Ceramic, 0.1 μ F, 50V	1		27	SFUM132-12	Gear, Operation Plate	1	○
C308	ECEA6V220	Electrolytic, 220 μ F, 6V	1		28	SFUM132-13	Cam, Select	2	○
C310	ECQM1H102KZ	Polyester, 0.001 μ F, 50V, \pm 10%	1		28-1	SFYB5-32	Steel Ball, Select Cam	2	*
C401, 402	ECEA16Z47	Electrolytic, 47 μ F, 16V	2		28-2	SFOA829-2	Spring, Select Cam	2	
C403, 404	ECEA50V2R2	Electrolytic, 2.2 μ F, 50V	2		28-3	XTN3+8B	Screw, Operation Plate	3	
C501	ECEA50ZR1	Electrolytic, 1 μ F, 50V	1		28-4	XTN3+8B	Screw, Operation Plate	2	
C502	ECQM1H473KZ	Polyester, 0.047 μ F, 50V, \pm 10%	1		29	SFUP132-02E	Bracket, Power Switch	1	○
C503	ECQM1H184KZ	Polyester, 0.18 μ F, 50V, \pm 10%	1		29-1	SFUZ132-02	Felt, Power Switch Knob	1	○
C504	ECQM1H473KZ	Polyester, 0.047 μ F, 50V, \pm 10%	1		29-2	SFXJ132-03	Support, Power Switch Knob	1	○
C505	ECEA25Z4R7	Electrolytic, 4.7 μ F, 25V	1		29-3	SFQA001-02	Spring, Power Switch knob	1	
C601	ECQF1A473MD	Polyester, 0.047 μ F, 125V, \pm 20%	1		29-4	SFUP001-10	Support, Power Switch Knob	1	
CABINET and CHASSIS PARTS					30	SFUM001-11	Cam, Power Switch	1	
1	SFAD132-01A	Dust Cover	1	○	30-1	SFUP001-12	Support, Power Switch	1	
2	SFAT165-01A	Hinge Ass'y	2		30-2	SFUM132-07	Cam, Power Switch Cam	1	○
3	SFTG170-01	Turntable Mat	1		31	SFUM132-05	Holder, Power Switch	1	○
4	SFTE132-01A	Turntable	1	○	32	SFUM132-06	Holder, Power Switch	1	○
5	SFKT132-06A	Knob, Operation	2	○	32-1	XTN3+8B	Screw, Power Switch Bracket	2	
6	SFUM132-02	Cover, Panel	1	○	32-2	XTN3+16B	Screw, Power Switch Holder	1	
6-1	XTN3+8BFZ	Screw, Panel Cover	6	○	32-3	XSN3+10S	Screw, Power Switch Cam	1	
6-2	SFNN132M01	Name Plate	1	* ○	32-4	XWC3B	Washer, Power Switch Cam	1	
7	SFUM132-04	Cover, Power Transformer	1	○	33	SFUP132-08	Mirror	1	○
7-1	XTN3+10BFZ	Screw, Power Transformer Cover	2		34	SFUP132-04	Bracket, Panel	1	○
7-2	XWG3	Washer, Power Transformer Cover	2		34-1	XTN3+6B	Screw, Panel Bracket	1	
8	RJA10A	AC Cord	1		35	SFKT132-05	Knob, Power Switch	1	○
9	SFUM170-06	Spacer, AC Power Cord	1		36	SFUM132M01	Panel	1	○
10	SFUM170-05	Bracket, AC Power Cord	1		37	SFKT132-03	Knob, Operation	4	○
10-1	XTN3+14BFZ	Screw, AC Power Cord Bracket	2		38	SFKT132-04	Knob, Operation	1	○
10-2	XWG3	Washer, AC Power Cord Bracket	2		39	SFKT132-01E	Knob, Operation	1	○
11	SFUM170-07	Case, Hinge Ass'y	2		40	SFKT132-02E	Knob, Operation	1	○
11-1	XTN3+8BFZ	Screw, Hinge Ass'y Case	4		41	SFUM132-09	Felt	1	○
12	SFDH028-01	Phono Cord	1		41-1	XWA3B	Washer, Panel	4	
13	SFEL028-01E	Ground Wire	1		41-2	XNG3BS	Nut, Panel	4	
14	SFUM170-06	Spacer, Phono Cord	1		41-3	XTN3+8B	Screw, P.C.B	8	
15	SFUM170-11	Bracket, Phono Cord	1		42	SFXB132-02	Spacer, Operation	2	○
15-1	XTN3+14BFZ	Screw, Phono Cord Bracket	2		42-1	SFXB132-01	Spacer, Operation	5	○
15-2	XWG3	Washer, Phono Cord Bracket	2		42-2	SFXG132-01	Screw, Operation	4	○
16	XTN3+8B	Screw, Phono P.C.B	1		42-3	XNS6JM	Nut, Operation Spacer	2	
17	SFAC132-01	Cabinet	1	○	42-4	XNG4HS1	Nut, Operation Spacer	5	
18	XTN3+8B	Screw, P.C.B	2		42-5	SFQA132-01	Spring, Operation Knob	2	○
19	SFUP132-03	Bracket, Power Transformer	1	○	42-6	SFQA132-02	Spring, Operation Knob	5	○
19-1	SFGC132-01	Spacer (Rubber), Power Transformer Bracket	1	○	42-7	XUC3FT	Circlip, Operation Knob	2	
19-2	XTN4+10B	Screw, Power Transformer	2		42-8	XUC25FT	Circlip, Operation Knob	5	
19-3	SFXW750-01	Washer, Power Transformer Bracket	3		43	SFMZ132-01Z	D.D. Motor Ass'y	1	○
19-4	XTN3+10B	Screw, Power Transformer Bracket	3		44	SFUM190-34	Index Plate	1	
20	SFKT132-07	Knob, Manual Switch	1	○	44-1	XTN3+16B	Screw, Index Plate	1	
21	SFUP132-10	Bracket, Manual Switch	1	○	44-2	SFXW190-21	Washer, Index Plate	1	
22	SFDJ132-05E	Connector, 2P Ass'y	1	○	44-3	SFXW190-22	Washer, Index Plate	1	
22-1	XTN3+8B	Screw, Manual Switch	4		44-4	SFXW190-23	Washer, Index Plate	1	
23	SFUK132-01E	Operation Plate Ass'y	1	○	45	SFUB190-21A	Operating Plate Ass'y	1	
					46	SFUM190-31	Support, Switch Plate	1	
					47	SFUM190-28	Plate, Switch	1	
					48	XTN3+8B	Screw, P.C.B	1	
					49	SFUK190-01E	Base, Automatic Mechanism	1	

EXPLODED VIEW

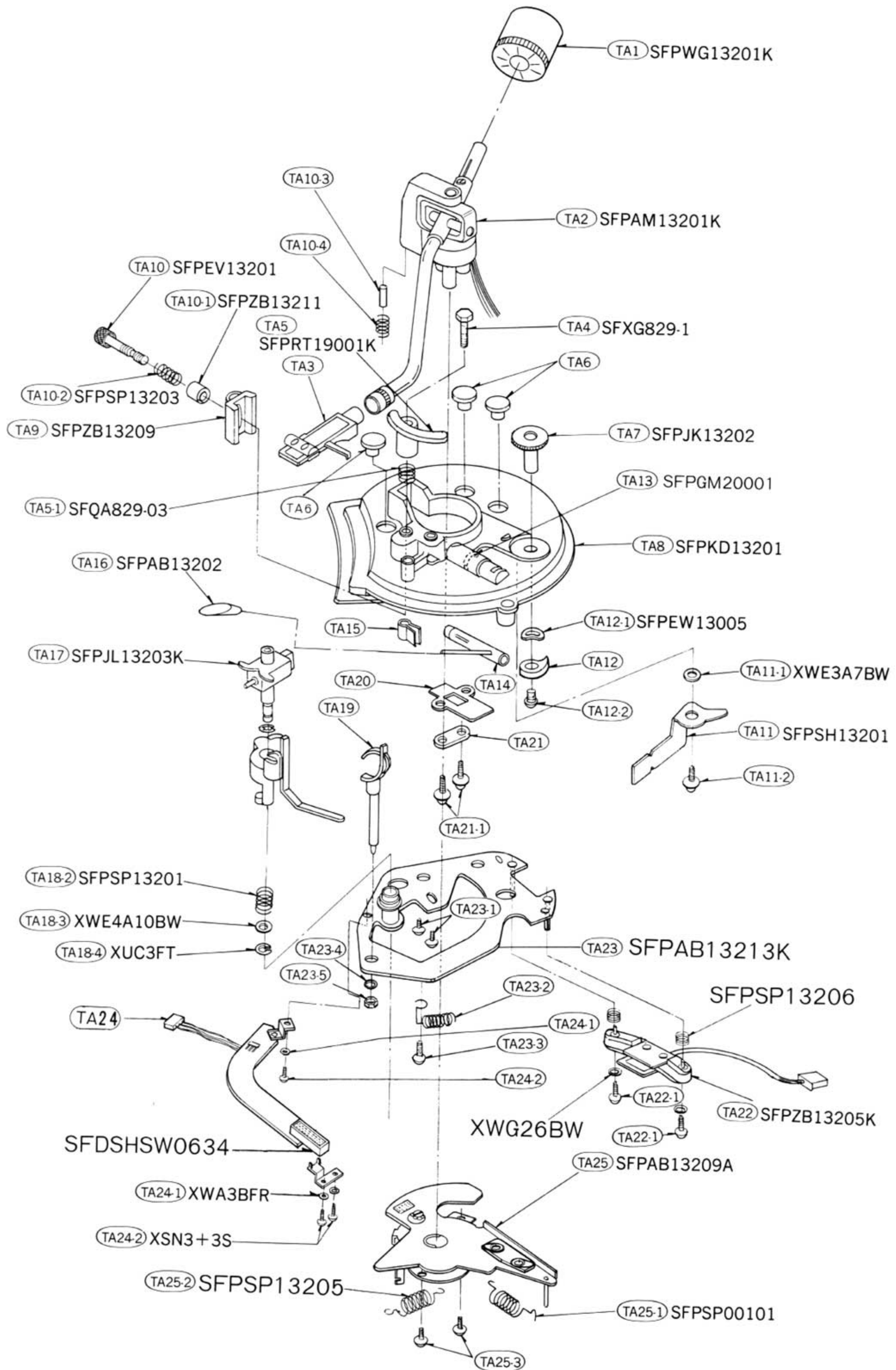

EXPLODED VIEW

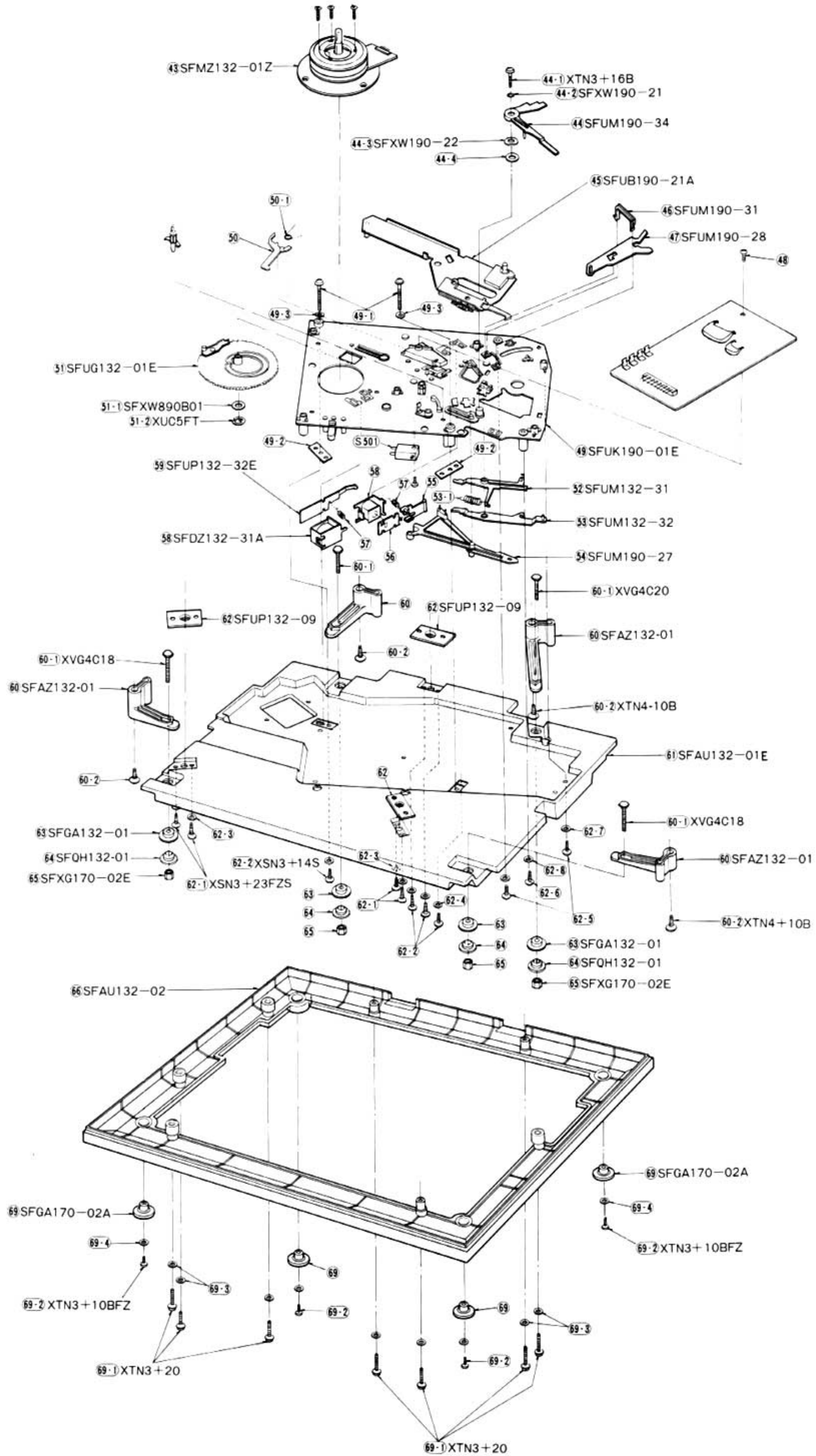

Ref. No.	Part No.	Part Name & Description	Per Set	Remarks
49-1	XTN4+35B	Screw, Automatic Mechanism	2	
49-2	SFUP190-02	Bracket, Automatic Mechanism Base	2	
49-3	XWG4	Washer, Automatic Mechanism	2	
50	SFUM190-26	Support, Gear Setting	1	
50-1	SFQS190-21	Spring, Gear Setting Support	1	
51	SFUG132-01E	Main Gear Ass'y	1	○
51-1	SFXW890B01	Washer, Main Gear	1	
51-2	XUC5FT	Circlip, Main Gear	1	
52	SFUM132-31	Lever, Start Set	1	○
53	SFUM132-32	Support, Start Set Lever	1	○
53-1	SFQH130-14	Spring, Start Set Lever Support	1	
54	SFUM190-27	Lever, Switching	1	
55	SFUM132-33	Support, Solenoid	1	○
56	SFUP132-31E	Support, Solenoid	1	○
57	SFQH910-05	Spring, Solenoid	2	
58	SFDZ132-31A	Solenoid Ass'y	2	○
59	SFUP132-32E	Support, Solenoid	1	○
60	SFAZ132-01	Insulator (A)	4	○
60-1	XVG4C18	Screw, Insulator (A)	4	
60-2	XTN4+10B	Screw, Insulator (A)	4	
61	SFAU132-01E	Base, Main	1	
62	SFUP132-09	Bracket, Main Base	3	○
62-1	XSN3+23FZS	Screw, Main Base Bracket	4	
62-2	XSN3+14S	Screw, Main Base Bracket	4	
62-3	XWG3	Washer, Main Base Bracket	4	
62-4	XWG3	Washer, Main Base Bracket	4	
62-5	XTN4+35B	Screw, Main Base	2	
62-6	XTN3+35B	Screw, Main Base	6	
62-7	XWG4	Washer, Main Base	2	
62-8	XWG3	Washer, Main Base	6	
63	SFGA132-01	Rubber, Insulator (A)	4	○
64	SFQH132-01	Spring, Insulator (A)	4	○
65	SFXG170-02E	Nut, Insulator (A)	4	
66	SFAU132-02A	Bottom, Cover	1	○
69	SFGA170-02A	Insulator (B)	4	
69-1	XTN3+20	Screw, Bottom Cover	7	
69-2	XTN3+10BFZ	Screw, Insulator (B)	4	
69-3	XWG3	Washer, Bottom Cover	7	
69-4	XWG4	Washer, Insulator (B)	4	
TONE ARM and ARM BASE				
TA1	SFPWG13201K	Balance Weight Ass'y	1	○
TA2	SFPAM13201K	Tone Arm Ass'y	1	○
TA3	SFPCC10001K	Head Shell	1	○
TA4	SFXG829-1	Screw, Tone Arm Lift Adjustment	1	
TA5	SFPRT19001K	Lift Ass'y	1	
TA5-1	SFQA829-03	Spring, Lift Ass'y	1	
TA6	SFGK132M01	Cap, Rubber	3	○
TA7	SFPJK13202	Knob, Anti-skate Force Control	1	○
TA8	SFPKD13201	Arm Base	1	○
TA9	SFPZB13209	Bracket, Tone Arm	1	○
TA10	SFPEV13201	Screw, Tone Arm Bracket	1	○
TA10-1	SFPZB13211	Cover, Spring	1	○
TA10-2	SFPSP13203	Spring, Tone Arm Bracket Screw	1	○

Ref. No.	Part No.	Part Name & Description	Per Set	Remarks
TA10-3	SFPZB13212	Pin, Tone Arm Bracket Screw	1	○
TA10-4	SFPSP13204	Spring, Tone Arm Bracket Screw	1	○
TA11	SFPSP13201	Support, Anti-skate Force Control	1	○
TA11-1	XWE3A7BW	Washer, Anti-skate Force Control Support	1	
TA11-2	XTN3+5B	Screw, Anti-Skate Force Control Support	1	
TA12	SFPJK17002	Cam, Anti-Skate Force Control	1	
TA12-1	SFPEW13005	Washer, Anti-Skate Force Control Knob	1	
TA12-2	XTN26+5B	Screw, Anti-Skate Force Control	1	
TA13	SFPGM20001	Rubber, Cueing Lever	1	
TA14	SFPJL13201K	Cueing Lever Ass'y	1	○
TA15	SFPZB13204	Plate, Arm Rest	1	○
TA16	SFPAB13202	Knob, Arm Lift	1	○
TA17	SFPJL13203K	Lift Bar Ass'y	1	○
TA18-2	FPSP13201	Spring, Arm Lift Base	1	○
TA18-3	XWE4A10BW	Washer, Arm Lift Base	1	
TA18-4	XUC3FT	Circlip, Arm Lift Base	1	
TA19	SFPRT13201K	Arm Rest	1	○
TA20	SFPAB13203	Plate, Lift	1	○
TA21	SFPZB13208	Support, Lift	1	○
TA21-1	XTN3+5B	Screw, Lift Support	2	
TA22	SFPZB13205K	Support, P.C.B	1	○
TA22-1	XSN26+8S	Screw, Support	2	
TA23	SFPAB13213K	Base, Arm Lift	1	○
TA23-1	XSN3+5S	Screw, Arm Lift Base	2	
TA23-2	SFPSP13202	Spring	1	○
TA23-3	XSN3+3S	Screw, Spring	1	
TA23-4	XWA26B	Washer, Arm Rest	1	
TA23-5	XNG26BFN	Nut, Arm Rest	1	
TA24	SFPAB13218K	Cord, PU Output Ass'y	1	○
TA24-1	XWA3B	Washer, P.C.B. Ass'y	2	
TA24-2	XSN3+3S	Screw, P.C.B. Ass'y	2	
TA25	SFPAB13209A	Tone Arm Fixing Plate Ass'y	1	○
TA25-1	SFPSP00101	Spring	1	
TA25-2	SFPSP13205	Spring, Tone Arm Fixing Plate Ass'y	1	
TA25-3	XSN3+6S	Screw	2	
ACCESSORIES				
A1	SFNU132M01	Instruction Book	1	○
A2	SFWE154A1	Adaptor, 45 r.p.m	1	
A3	SFCFB20502	Driver, Screw	1	
A4	SFWO010	Oil	1	
A5	SFPEV7803	Screw, Cartridge	2	
A5-1	SFPEV10005	Screw, Cartridge	2	
A5-2	SFPEV10009	Screw, Cartridge	2	
A5-3	SFPEN9200	Nut, Cartridge	2	
A5-4	SFYF05A06	Polyethylene Bag	1	
PACKING PARTS				
P1	SFHP132M01	Carton	1	○
P2	SFHH132-01	Pad, Front	1	○
P3	SFHH132-02	Pad, Rear	1	○
P4	SFHD132-02	Pad, Turntable	1	○

Ref. No.	Part No.	Part Name & Description	Per Set	Remarks
P5	SFHD132-01	Pad, Top	1	○
P6	SFHH170-03	Parts Box	1	
P7	SFHD170-03	Pad, Top, Parts Box	1	
P7-1	SFYC22A30	Polyethylene Cover	1	
P8	XST6D30B	Screw, Clamp	3	○
P9	SFYF60A60	Polyethylene Bag, Player Unit	1	
P9-1	SFYH40X45	Polyethylene Bag, Turntable	1	
P9-2	SFYH10X30	Polyethylene Bag, AC Cord	2	○

PACKINGS

