



OVEN

BASIC: BQ1Q4T090
MODEL: BQ1VQ6T012
MODEL CODE : BQ1VQ6T012/XEF

SERVICE Manual

OVEN



CONTENTS

- 1. Precaution
- 2. Product Specification
- 3. Disassembly and Reassembly
- 4. Troubleshooting
- 5. Exploded Views and Parts List
- 6. PCB Diagrams
- 7. Wiring Diagrams
- 8. Schematic Diagrams



Contents

1. Precaution	1
1-1 Safety precautions	1
2. Specifications	2
2-1 Features	2
2-2 Specification	3
2-3 Accessory	4
3. Disassembly and Reassembly	5
3-1 Tools for Removal and Reassembly	5
3-2 Replacement of Case upper & Cover back	5
3-3 Replacement the Tube	6
3-4 Replacement of Door Assembly	7
3-5 Replacement of Door Glass	8
3-6 Replacement of the rear oven Lamp Bulb	10
3-7 Replacement of the side Halogen Lamp	10
3-8 Replacement of Assy Control Box	11
3-9 Replacement of Tube Steam Module	13
3-10 Replacement of Assy Steam Module	15
3-11 Assembly for Main Assy Steam module part	18
3-12 Replacement of Assy generator sub	20
3-13 Replacement of Motor Fan Cooling	21
3-14 Replacement of Duct Cover, Bracket & Spring Duct & Ceramic Filter	21
3-15 Replacement of Motor Convection	22
3-16 Replacement of Heater Convection twin	23
3-17 Replacement of Assy Partition S/W	23
3-18 Replacement of Thermostat	24
3-19 Replacement of Terminal Block	24
3-20 Replacement of Sensor Thermistor	24
3-21 Replacement of Heater Grill	25
3-22 Replacement of Heater Bottom	25
3-23 Replacement of Assy PCB Parts (Main PCB)	26
3-24 Replacement of Assy-Door Lock	26
4. Troubleshooting	27
4-1 Failure Codes	27
5. Exploded Views and Parts List	43
5-1 Exploded Views	43
5-2 Main Parts List	44
5-2 Main Parts List	45
5-3 Door Parts List	46
5-4 Control Parts List	47
5-5 Standard Parts List	48
6. PCB Diagram	49
6-1 PCB Diagram	49
7. Wiring Diagram	50
7-1 Wiring Diagram	50
8. Schematic Diagram	51
8-1 Schematic Diagram	51

1. Precaution

Follow these special safety precautions.

1-1 Safety precautions (⚠)

1. All repairs should be done in accordance with the procedures described in this manual. This product complies with Federal Performance Standard 21 CFR Subchapter J(DHHS).
 2. Check all grounds.
 3. Do not power the OVEN from a "2-prong" AC cord. Be sure that all of the built-in protective devices are replaced. Restore any missing protective shields.
 4. When reinstalling the chassis and its assemblies, be sure to restore all protective devices including nonmetallic control knobs and compartment covers.
 5. Make sure that there are no cabinet openings through which people --particularly children --might insert objects and contact dangerous voltages.
 6. Service technicians should remove their watches while repairing an OVEN.
 7. Design Alteration Warning:
Use exact replacement parts only, i.e., only those that are specified in the drawings and parts lists of this manual. Never alter or add to the mechanical or electrical design of the OVEN. Any design changes or additions will void the manufacturer's warranty. Always unplug the unit's AC power cord from the AC power source before attempting to remove or reinstall any component or assembly.
 8. Never defeat any of the B+ voltage interlocks. Do not apply AC power to the unit (or any of its assemblies) unless all solid-state heat sinks are correctly installed.
 9. Some semiconductor ("solid state") devices are easily damaged by static electricity. Such components are called Electrostatically Sensitive Devices (ESDs). Examples include integrated circuits and field-effect transistors. Immediately before handling any semiconductor components or assemblies, drain the electrostatic charge from your body by touching a known earth ground.
 10. Always connect a test instrument's ground lead to the instrument chassis ground before connecting the positive lead; always remove the instrument's ground lead last.
 11. Components that are critical for safety are indicated in the circuit diagram by shading,  or .
 12. Use replacement components that have the same ratings, especially for flame resistance and dielectric strength specifications. A replacement part that does not have the same safety characteristics as the original might create shock, fire or other hazards.
- NOTE:** Connect the oven to a 25 A.
When connecting the oven to a 16 A,
make sure that circuit breaker can operate.
13. Never touch any circuit wiring with your hand nor with uninsulated tool during operation.
 14. For your safety, wear gloves on your hands.
 15. Remove the all water from water-tank and Steam generator, before repairing the oven set.

2. Specifications

2-1 Features

		BASIC MODEL Built In Oven	NEW MODEL Built In Oven
Model Name		BQ1Q4T090	BQ1VQ6T012
Model Type Install		Single Built-in	Single Built-in
Design		GEO	GEO
Main sales point		Dual cook	Dual cook
Oven Features			
Cavity Interior		Pyro Lytic Coating	Pyro Lytic Coating
Oven Colors		STSS	STSS
Oven Doors (D: double, T: triple, Q: quadruple)		Q	Q
Door Opening		Drop Down	Drop Down
Interior Lamp		1(Halogen)	2(Halogen)
Interior Lights position		Back/Side	Back/Side
Control Method(Oven)		Tact Button & Dial	Tact & Touch & Dial
Display		2 Layer LED	2 Layer LED
Cleaning Method Oven		Steam & Self	Steam & Self & Descaling
Heater		Drop Down	Fixed
Electric Features			
Oven Temp Ranges - Single		40~300 °C 300 °C: Grill only	40~270 °C 270 °C: Grill only
- Upper or Lower		170~250 °C	170~250 °C
Grill Heater (In/Out)		1600W/1100W	1600W/1100W
Bottom Heater		1100W	1100W
Convection Heater (Upper/Lower)		1200W/1200W	1200W/1200W
Energy Class		A/A/A	A/A/A
Oven Function			
Number of Functions		11	15
Single Mode 1. Convection		Yes	Yes
2. Top heat + convection		Yes	Yes
3. Conventional		Yes	Yes
4. Large Grill		Yes	Yes
5. Small Grill		Yes	Yes
6. Bottom + convection		Yes	Yes
7. Steam cook		-	Yes
6. Steam assist cook		-	Yes

2-1 Features

		BASIC MODEL Built In Oven	NEW MODEL Built In Oven
UPPER Mode	1. Convection	Yes	Yes
	2. Top heat + convection	Yes	Yes
	3. Large grill	Yes	Yes
LOWER Mode	1. Convection	Yes	Yes
	2. Bottom heat + convection	Yes	Yes
	3. Steam cook	-	Yes
	4. Steam assist cook	-	Yes
Control Features			
Clock		Yes	Yes
Child Safety Lock		Yes	Yes (Hidden)
Sound On/Off		Yes (Hidden)	Yes (Hidden)
Count Timer		Yes	Yes
Cook Time		Yes	Yes
End Time		Yes	Yes
Oven Temp		Yes	Yes
Steam Cleaning		Yes	Yes
Self Cleaning		Yes	Yes
Language Option		No	No
Light On/Off		Yes	Yes
Sound		Smart buzzer	Smart buzzer
Equipment Supplied			
Multi spit		No	No
Barbecue spit		YES	No
Square Baking Tray		2	2
Square Wire Rack		1	2

2-2 Specification

Specifications		BASIC	NEWMODEL
Power source		230V 50Hz, AC	230V 50Hz, AC
Dimension (W x H x D)	Outside	595 x 595 x 566mm	595 x 595 x 566mm
	Cavity	440 x 365 x 405mm	440 x 365 x 405mm
Shipping weight		Net 47Kg, Gross 52Kg	Net 49Kg, Gross 55Kg

2-3 Accessory

The following accessories are provided with your oven.



	Description	Code No.	Q'ty
	RACK-WIRE	DG59-00001A	1
	RACK-WIRE ROAST	DG59-00004A	1
	TRAY-BAKING A	DG63-00012A	1
	TRAY-BAKING B	DG63-00011A	1
	ASSY-PARTITION	DG97-00015A	1
	STEAM-GLASS STEAM-TRAY SUB STEAM-TRAY	DG01-00010A DG63-00246A DG63-00242A	1

3. Disassembly and Reassembly

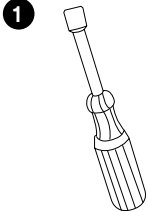
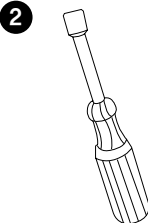
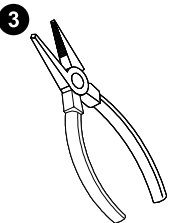
3-1 Tools for Removal and Reassembly

Tool	
	<ol style="list-style-type: none">1. Tool : Nut Driver2. Type : 7mm3. Remarks : Heater bracket Nut
	<ol style="list-style-type: none">1. Tool : Nut Driver2. Type : 9mm3. Remarks : Convection Fan Nut
	<ol style="list-style-type: none">1. Tool : Longnose2. Remarks : Tube Clamp

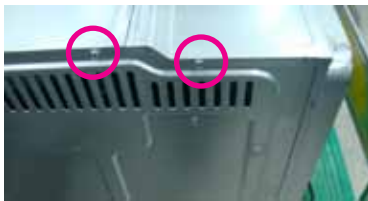



3-2 Replacement of Case upper & Cover back

  	<p>* You must remove it before the repair</p>
---	---

3. Disassembly and Reassembly

3-3 Replacement the Tube



The Assembly is reverse order of disjoining.

Parts	Explanation Photo	Explanation
Tube		1. Prepare long-nose to remove the Tube clamp.
		2. Grab the Tube clamp with long-nose.
		3. remove the Tube clamp.
		4. remove the Tube.

3. Disassembly and Reassembly

3-4 Replacement of Door Assembly

The Assembly is reverse order of disjoining.

Parts	Explanation Photo	Explanation
Door Assembly		<ol style="list-style-type: none">1. Turn over the clips of both hinges.
		
		<ol style="list-style-type: none">2. With both hands, grasp the middle sides of the oven door.3. Rotate the door by approx. 70degree until the hinges can be taken out completely from the hinges holes.

3-5 Replacement of Door Glass

The Assembly is reverse order of disjoining.

WARNING

Whenever the door is separated from the oven, the clips should always be turned over.

When the door is mounted, if some of the parts (Door glass or other parts) are removed from the door, it can cause injury due to sheet.

ATTENTION

The glass may break if you use force especially on the edges of the front sheet.

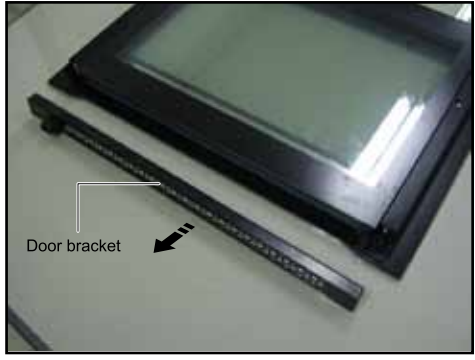
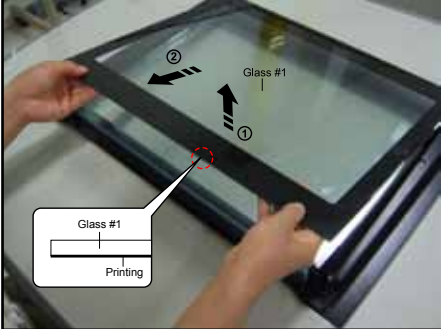
Parts	Explanation Photo	Explanation
Door Glass		<ol style="list-style-type: none">1. Remove the two screws of the left and right sides of the door.
		<ol style="list-style-type: none">2. Take off the door bracket.
		<ol style="list-style-type: none">3. Detach the inner glass #1 (number 1) from the door. * When assembly the inner glass#1, put printing to direction below.

3-5 Replacement of Door Glass (Continued)

The Assembly is reverse order of disjoining.

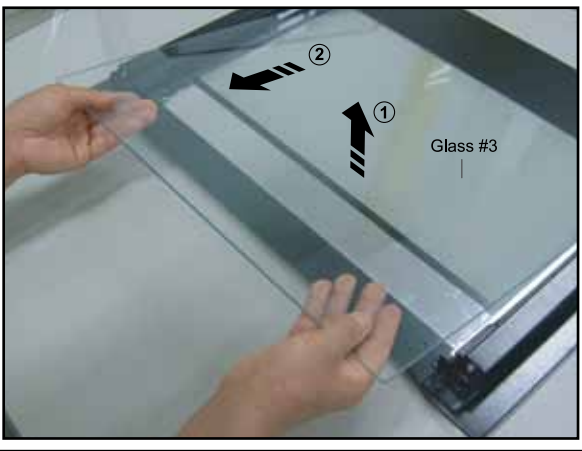
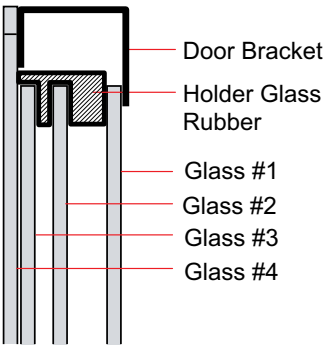
Parts	Explanation Photo	Explanation
<p>Door Glass</p>		<p>4. Detach the inner glass #2 and spring-brackets from the door.</p>
		
		

3-6 Replacement of the rear oven Lamp Bulb

The Assembly is reverse order of disjoining.

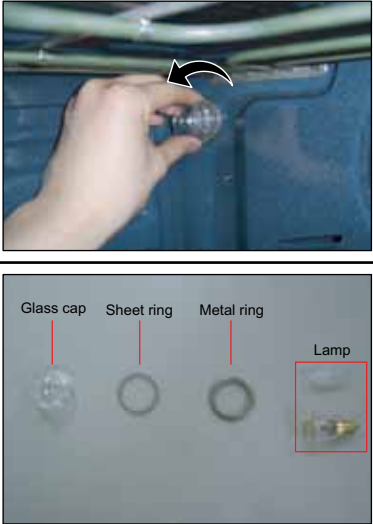
Parts	Explanation Photo	Explanation
Lamp Bulb		<ol style="list-style-type: none"> 1. Take off the cap by turning counterclockwise. 2. Remove the metal ring and the sheet ring and clean the glass cap. 3. If necessary, replace the bulb with a 25 watt, 230 V, 300 °C heat - resistant oven light bulb. 4. Fit the metal and the sheet ring to the glass cap. 5. Replace the glass cap.

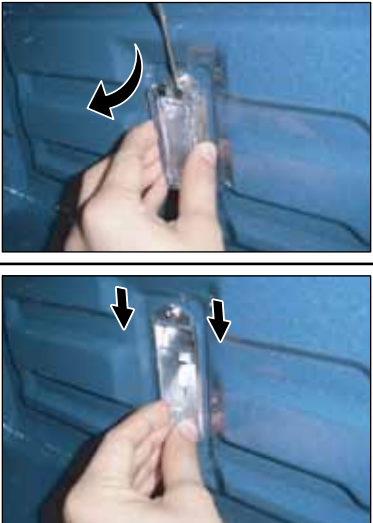

3-7 Replacement of the side Halogen Lamp

The Assembly is reverse order of disjoining.

Parts	Explanation Photo	Explanation
Lamp Bulb		<ol style="list-style-type: none"> 1. To remove the glass cover, hold the lower end with one hand, insert a flat sharp implement such as a table knife between the glass and the frame and pop out the cover. 2. If necessary, replace the halogen bulb with a 25 ~ 40 watt, 230 V, 300 °C heat - resistant halogen oven light bulb. <div style="border: 2px solid black; padding: 5px; margin: 10px 0;"> <p style="text-align: center;">Tip</p> <p>Always use a cloth when handling a halogen bulb to avoid depositing oils from your fingers on to the surface of the bulb.</p> </div> <ol style="list-style-type: none"> 3. Replace the glass cover.

3-8 Replacement of Assy Control Box

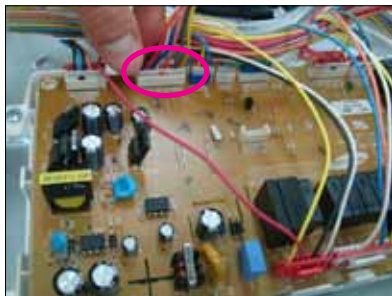
The Assembly is reverse order of disjoining.



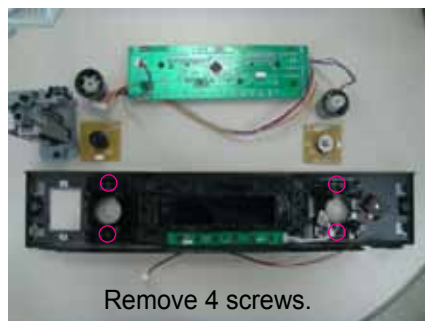
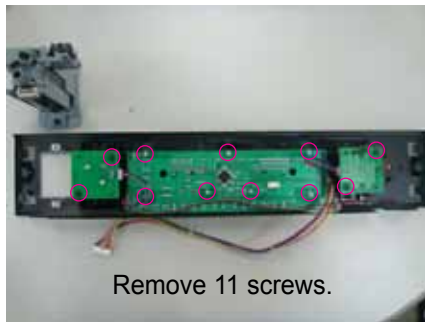
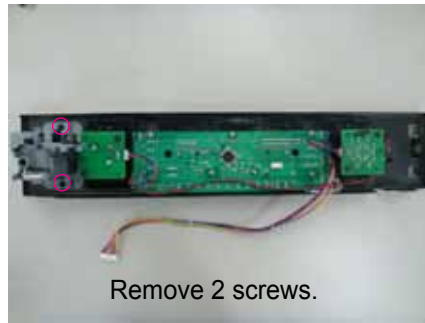

Parts	Explanation Photo	
Assy Control Box	 <p>Labels in the photo: Assy Knob Dial Encoder Parts, Assy Display, Buzzer, Assy Inlet, Assy Knob Dial Select Parts, Door Lock, Pump Motor, Assy PCB Parts (Main PCB), Motor Fan Cooling.</p>	
	Explanation Photo	Explanation
		<ol style="list-style-type: none"> 1. Remove one connector from the main pcb.
		<ol style="list-style-type: none"> 2. Remove two Tubes and one connector at assy inlet.
	<ol style="list-style-type: none"> 3. Remove 3 screws at both sides and top inside of assy control box, lift up assy control box and pull forward to separate. 	

3-8 Replacement of Assy Control Box (Continued)

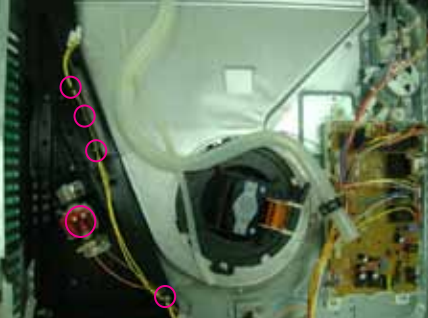

3-9 Replacement of Tube Steam Module

The Assembly is reverse order of disjoining.

Parts	Explanation Photo	Explanation
Tube Steam Module		<ol style="list-style-type: none"> 1. Remove the control-box.
		<ol style="list-style-type: none"> 2. Remove the 3 tubes.
		<ol style="list-style-type: none"> 3. Remove the 2 connectors and 4 hook.
		<ol style="list-style-type: none"> 4. Remove the 4 screws.



3-9 Replacement of Tube Steam Module (Continued)

The Assembly is reverse order of disjoining.

Parts	Explanation Photo	Explanation
		<p>5. Remove the Pump Motor.</p>
Tube Steam Module		<p>6. Remove 2 rubbers.</p>



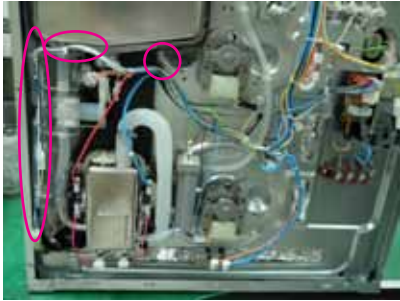
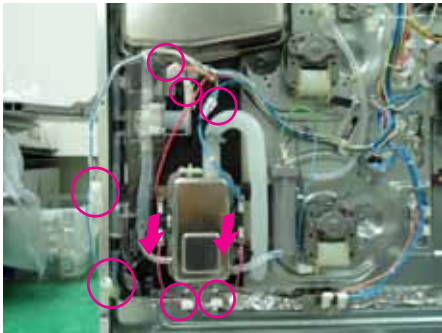

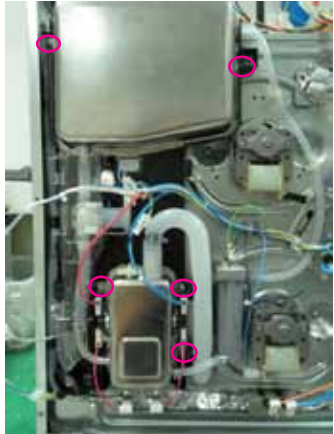
3-10 Replacement of Assy Steam Module

The Assembly is reverse order of disjoining.

Parts	Explanation Photo	Explanation
Assy Steam Module		<ol style="list-style-type: none"> 1. Separate the wire-harness from the hook on assy steam module and separate the 1 tube from assy steam generator.
		<ol style="list-style-type: none"> 2. Remove 7 connectors and 2 TCO from the assy steam generator. <p>* Lower Lamp is optional.</p>
		<ol style="list-style-type: none"> 3. Separate the 2 tubes.
		<ol style="list-style-type: none"> 4. Remove 5 screws.

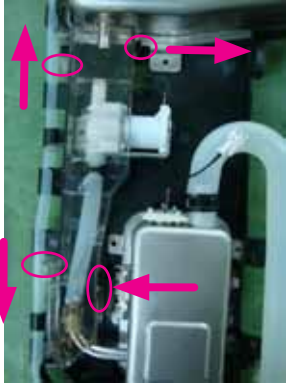

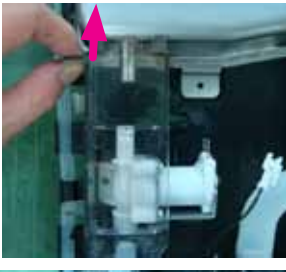
3-10 Replacement of Assy Steam Module (Continued)

The Assembly is reverse order of disjointing.



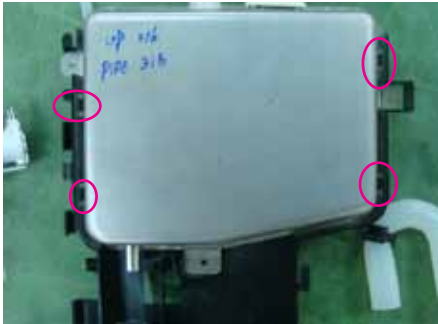

Parts	Explanation Photo	Explanation
Assy Steam Module		<p>5. Lift up assy steam module to separate from oven.</p>
		<p>Separate the cover upper steam. There are totally 4 hook that each has different direction.</p>
		<p>6. Separate right and up side hook first.</p>
		<p>7. Separate left and up side hook also.</p>
	<p>8. Separate last 2 hook.</p>	

3-10 Replacement of Assy Steam Module (Continued)

The Assembly is reverse order of disjoining.

Parts	Explanation Photo	Explanation
Assy Steam Module		<p>9. Remove 5 tubes.</p>
		<p>10. Separate the right side hook by using a flat head screwdriver. And then remove the assy steam generator.</p>
		<p>11. Separate the right side hook by using a flat head screwdriver. And then remove the water valve.</p>
		<p>12. Separate the 4 hook by using a flat head screwdriver. And then remove the assy water tank.</p>

3-11 Assembly for Main Assy Steam module part

Parts	Explanation Photo	Explanation
Assy Water tank		<ol style="list-style-type: none"> 1. Press the 4 point of assy water tank and check the right assembly with hook.
Water valve		<ol style="list-style-type: none"> 1. Insert left side of water valve into hook.
		<ol style="list-style-type: none"> 2. Press the right side of water valve.
Assy Steam generator		<ol style="list-style-type: none"> 1. Insert left side of assy steam generator into hook.

3-11 Assembly for Main Assy Steam module part (Continued)

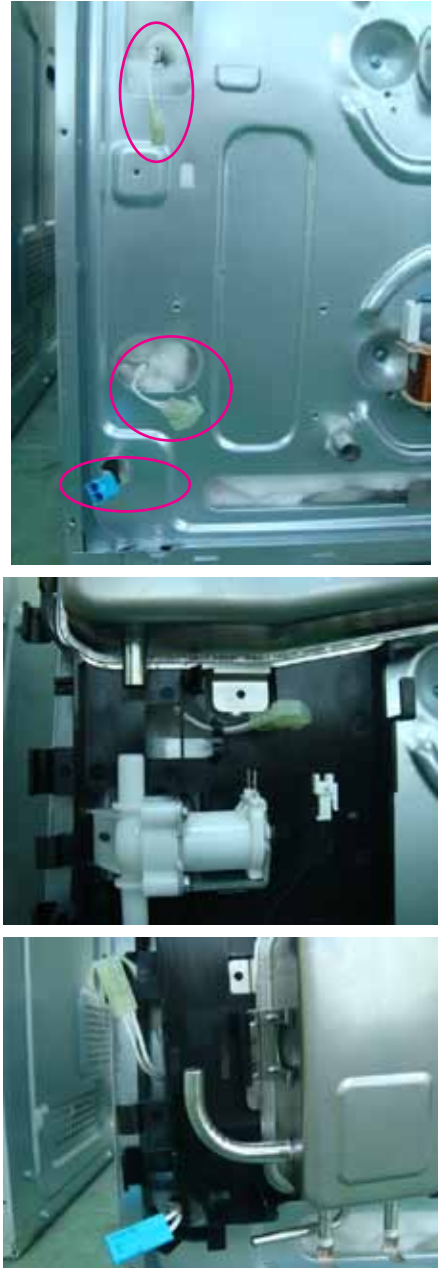
Parts	Explanation Photo	Explanation
Assy Steam generator		<ol style="list-style-type: none"> 2. Press the right side of assy steam generator.
Connectors and Assy steam module		<ol style="list-style-type: none"> 1. Check the right position between assy steam module hole and connector.

3-12 Replacement of Assy generator sub

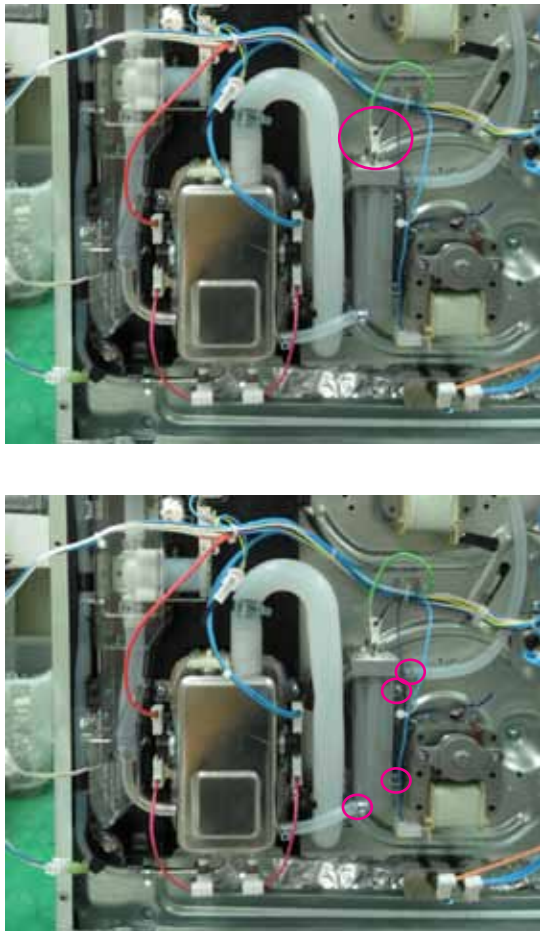
Parts	Explanation Photo	Explanation
Assy generator sub		<ol style="list-style-type: none"><li data-bbox="915 730 1219 758">1. Remove 2 connectors.<li data-bbox="915 793 1354 821">2. Remove the 2 tubes and 2 screws.

3-13 Replacement of Motor Fan Cooling

The Assembly is reverse order of disjoining.

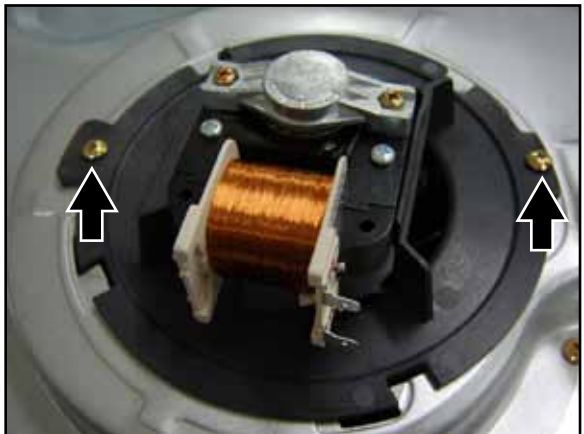

Parts	Explanation Photo	Explanation
Fan Cooling		<ol style="list-style-type: none">1. Remove two screws and turn toward the clockwise to separate.

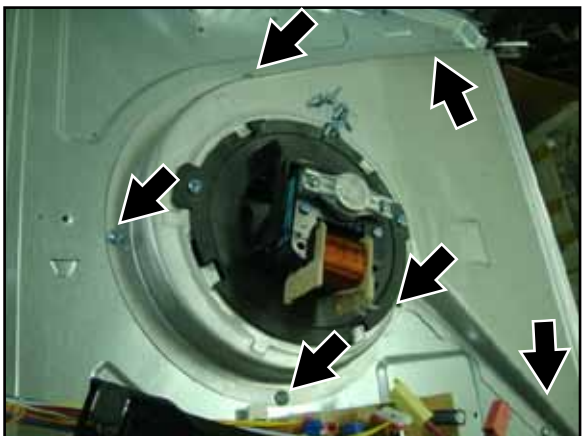
3-14 Replacement of Duct Cover, Bracket & Spring Duct & Ceramic Filter

Parts	Explanation Photo	Explanation
Fan Cooling		<ol style="list-style-type: none">1. Remove 6 screws from ass'y cover cooling motor.

3-15 Replacement of Motor Convection

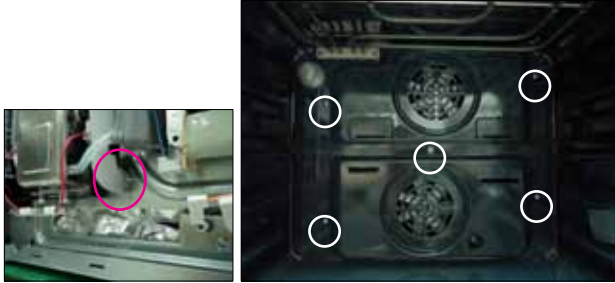
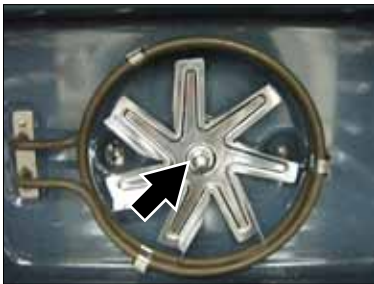

The Assembly is reverse order of disjointing.

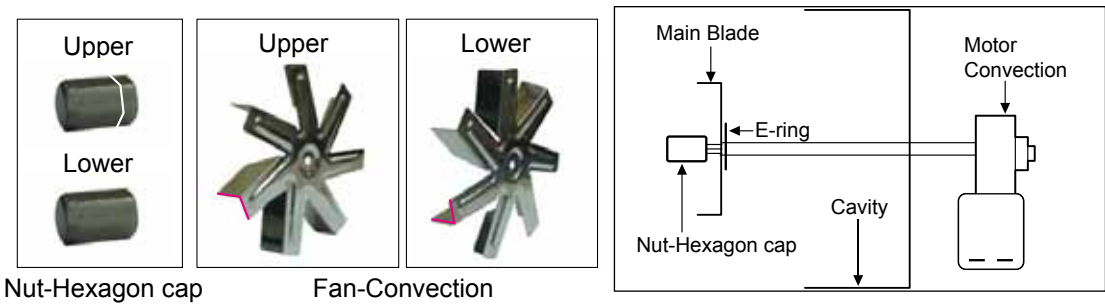
Parts	Explanation Photo	Explanation
Motor Convection		<ol style="list-style-type: none"> 1. Separate the 1 tube from the adiabatic rear. <p>* Be sure to connect tube again when assembly.</p> <ol style="list-style-type: none"> 2. Remove 5 screws at the back inside cavity to separate the cover casing.
		<ol style="list-style-type: none"> 3. Turn flange nut to the left to release and separate spacer fan convection and fan convection.
		<ol style="list-style-type: none"> 4. Remove two connector from convection motor 5. Remove turn toward the counter-clockwise to separate. <div style="border: 2px solid black; padding: 5px; margin-top: 10px;"> <p style="text-align: center;">Reference</p> <p>Convection fan is turn in the opposite direction each other for improvement cook performance. Upper fan is turn in counter-clockwise direction, Lower fan is fan turn in clockwise direction therefor convection fan direction and netflange are opposed each other.</p> <p>Convection fan is indicated (U),(L) and netflange is different the head shape.</p> </div>



3-16 Replacement of Heater Convection twin

The Assembly is reverse order of disjoining.

Parts	Explanation Photo	Explanation
Heater Convection Twin		<ol style="list-style-type: none">1. Remove the two connectors.2. Remove two screws securing heater convection twin at the rear.
		<ol style="list-style-type: none">3. Pull the securing bracket at the left forward, and pull it toward the left to separate heater convection twin.

3-17 Replacement of Assy Partition S/W

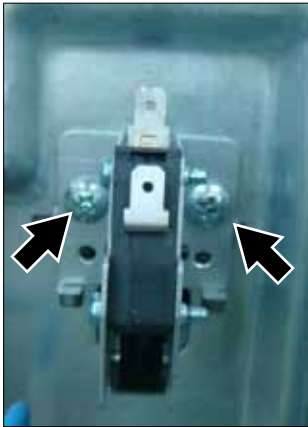
Parts	Explanation Photo	Explanation
Partition S/W		<ol style="list-style-type: none">1. Remove a connector.2. Remove two screws.

3-18 Replacement of Thermostat

The Assembly is reverse order of disjoining.

Parts	Explanation Photo	Explanation
Thermostat		<ol style="list-style-type: none">1. Unfold one point.

3-19 Replacement of Terminal Block

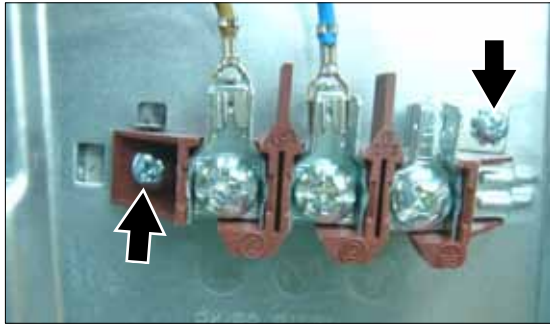

Parts	Explanation Photo	Explanation
Terminal Block		<ol style="list-style-type: none">1. Remove two wires from terminal block..2. Remove three screws.

3-20 Replacement of Sensor Thermistor

Parts	Explanation Photo	Explanation
Sensor Thermistor		<ol style="list-style-type: none">1. Remove one screws.

3-21 Replacement of Heater Grill

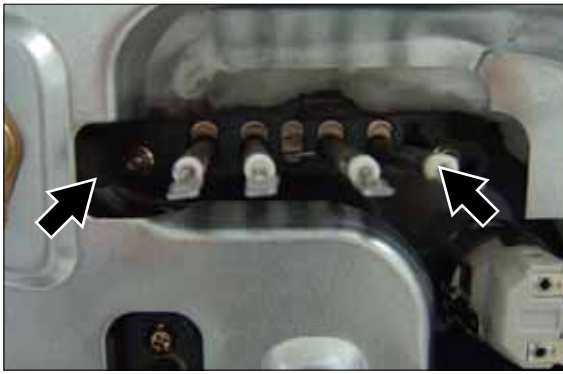
The Assembly is reverse order of disjoining.

Parts	Explanation Photo	Explanation
		<ol style="list-style-type: none"> 1. Remove the four connectors. 2. Remove each nut frange at right and left sides.
Heater Grill		<ol style="list-style-type: none"> 3. Turn the upper nut circular inside the cavity to the counterclockwise to release, pull heater grill forward to separate.

3-22 Replacement of Heater Bottom

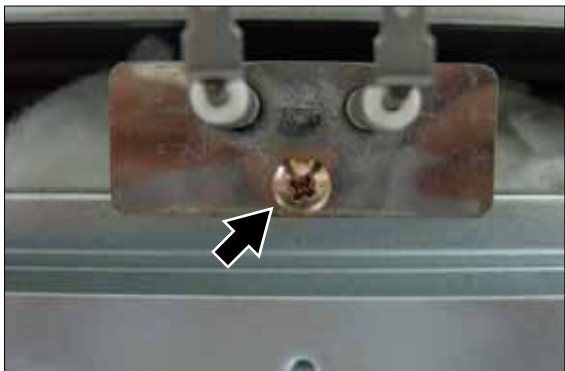
Parts	Explanation Photo	Explanation
Heater Bottom		<ol style="list-style-type: none"> 1. Remove the two connectors. 2. Remove one screw and pull forward to separate it.

3-23 Replacement of Assy PCB Parts (Main PCB)

The Assembly is reverse order of disjointing.

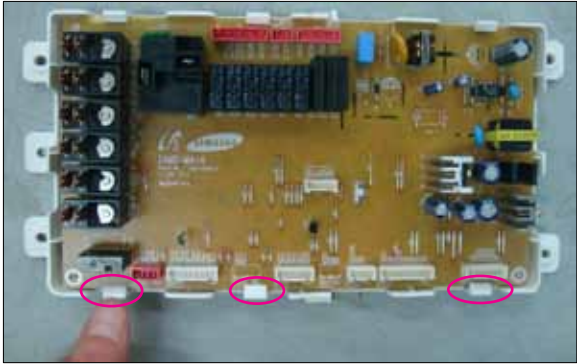
Parts	Explanation Photo	Explanation
Assy PCB Parts (Main PCB)		1. Remove a screw.
		2. Seperate 3 hook.

3-24 Replacement of Assy-Door Lock

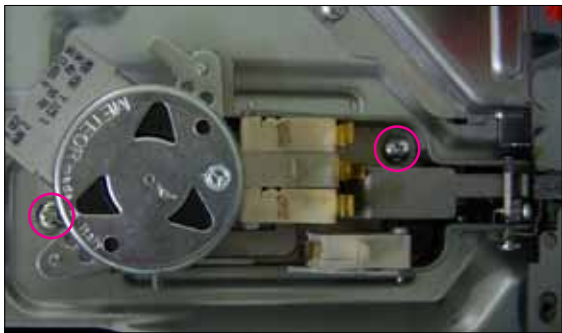
Parts	Explanation Photo	Explanation
Assy-Door Lock		1. Remove two screws.

4. Troubleshooting

4-1 Failure Codes

There are a kind of error code and two kinds of warning codes. Possible error codes during use can be checked before service. Press [Stand by Mode + Current time 0:00] and [Function + Time] at the same time and hold them for 5 seconds, error codes are displayed. Press [Function] button, the latest 5 error codes can be checked. But, if the oven turns off, the stored error codes are deleted. Press [Function + Time] button to return to 'normal display mode'.

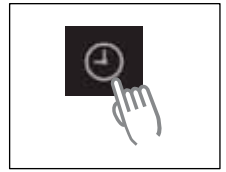
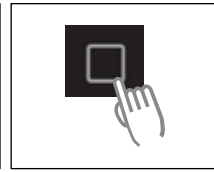





4-1-1 Temp Sensor Error

Error Code	General Function	Solution	Page
E-27	Cavity upper sensor open	Sensor Open Error It occurs due to a defective sensor, misplaced wires, a defective PCB.	29 Page
E-29	Cavity lower sensor open		
E-26	Cooling motor sensor open		
E-71	Steam generator sensor open		
E-28	Cavity upper sensor short	Sensor Short Error It occurs due to a defective sensor, misplaced wires, a defective PCB. It may occur when the ambient temperature falls under -5°C.	30 Page
E-2A	Cavity lower sensor short		
E-2C	Cooling motor sensor short		
E-72	Steam generator sensor short		

4-1-2 Safety Error

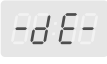
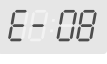
Error Code	General Function	Solution	Page								
S-01	Overtime <table border="1" style="margin-left: 20px;"> <thead> <tr> <th>Temp</th> <th>Time</th> </tr> </thead> <tbody> <tr> <td>~ 100°C</td> <td>16 hours</td> </tr> <tr> <td>105°C ~ 240°C</td> <td>8 hours</td> </tr> <tr> <td>245°C ~</td> <td>4 hours</td> </tr> </tbody> </table>	Temp	Time	~ 100°C	16 hours	105°C ~ 240°C	8 hours	245°C ~	4 hours	This error occurs when the oven works during CUT-OFF TIME in the same mode and at the same temperature without any operation of an user. This error is to prevent a risk of fire and hazards in case an user forgets to turn off the oven after use or the oven automatically starts in an unusual way. The oven can be used after off.	32 Page
Temp	Time										
~ 100°C	16 hours										
105°C ~ 240°C	8 hours										
245°C ~	4 hours										
-SE-	Touch Button Short	This error occurs when a button is pressed and held for over 10 seconds. It may occur when water soaks through the inside of the control panel or dust particles are stuck to TOUCH PAD. In this case, remove DISPLAY PCB, clean TOUCH PAD PCB or replace it.	31 Page								

4-1-2 Safety Error (Continued)

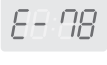
Error Code	General Function	Solution	Page
	Divider Missing	This error occurs when the divider sensing switch senses that the divider is used at the inappropriate mode.	33 Page
	Preheating Time Out	This error occurs when the set preheating time, 30 minutes, is over. It may occur due to a heater's open, defects of relay contact point and wiring defects.	35 Page
	Excess of cooking compartment's temperature	<ul style="list-style-type: none"> - This error occurs when the temperature of cooking compartment maintains over 320°C for more than 5 minutes. - This error occurs when a fire occurs inside cooking compartment or the temperature cannot be controlled because of sensor's failure. 	38 Page
	Excess of cooking compartment's temperature	<ul style="list-style-type: none"> - This error occur immediately after the temperature of cooking compartment reaches 350°C. - This error occurs when a fire occurs inside cooking compartment or the temperature cannot be controlled because of sensor's failure. 	38 Page
	Cooling motor lock sensed	<ul style="list-style-type: none"> - This error occurs when the temperature sensor on the Main PCB senses abnormal temperature. - It occurs 30 ~ 60 minutes after the cooling motor does not operate. - It may occur when the cooling motor stops running by power off during operation of the oven, then it runs again. 	34 Page
	Excess of steam generator temperature	- This error occurs when the temperature sensor in the steam generator senses abnormal temperature.	36 Page
	Water valve open sensed	- This error occurs when generator sensor can not sense the water even though water valve is opened for 30 sec.	28 Page

4-1-3 E-27,E-29, E-2b, E-71

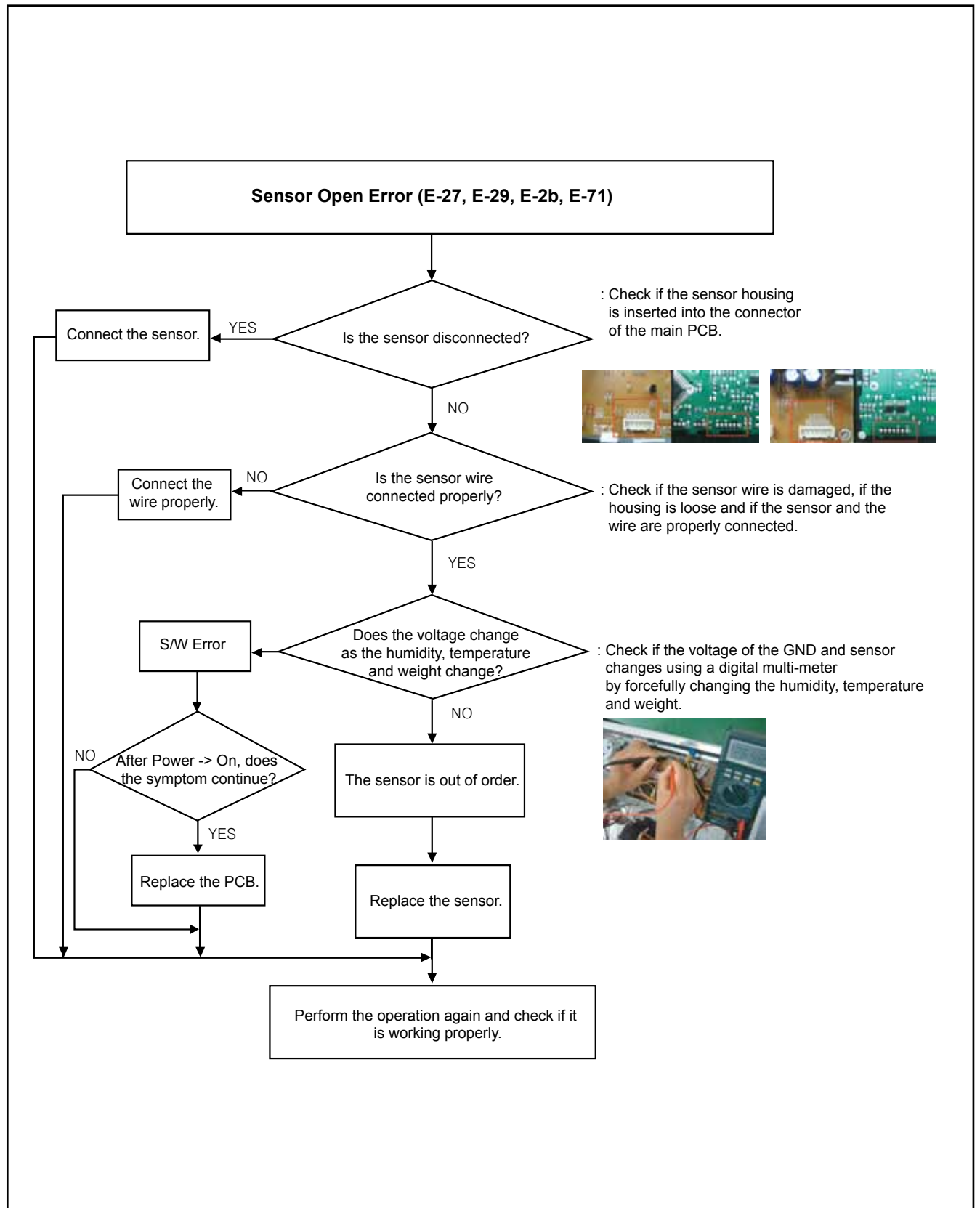

4-1-4 E-28, E-2A, E-2C, E-72

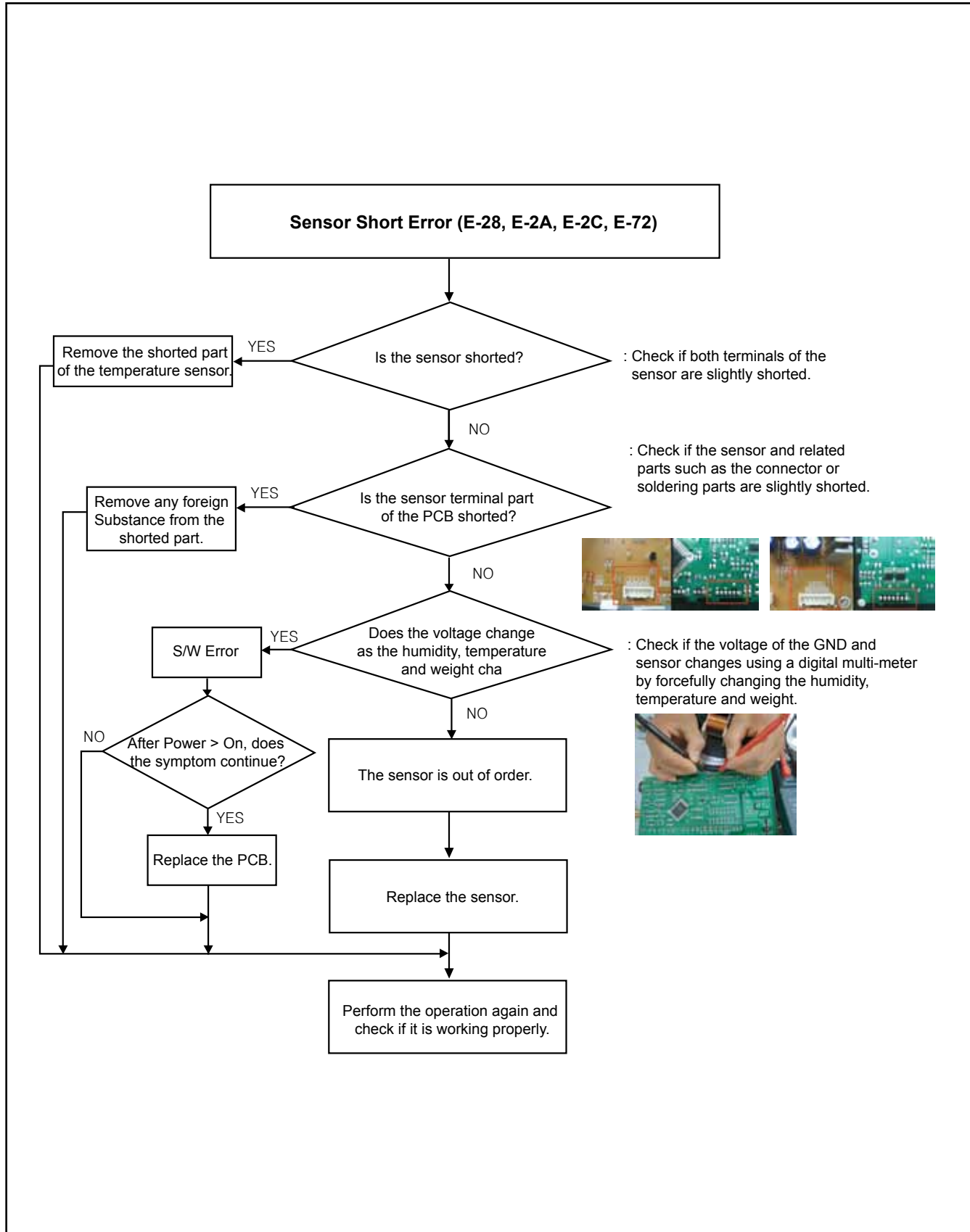

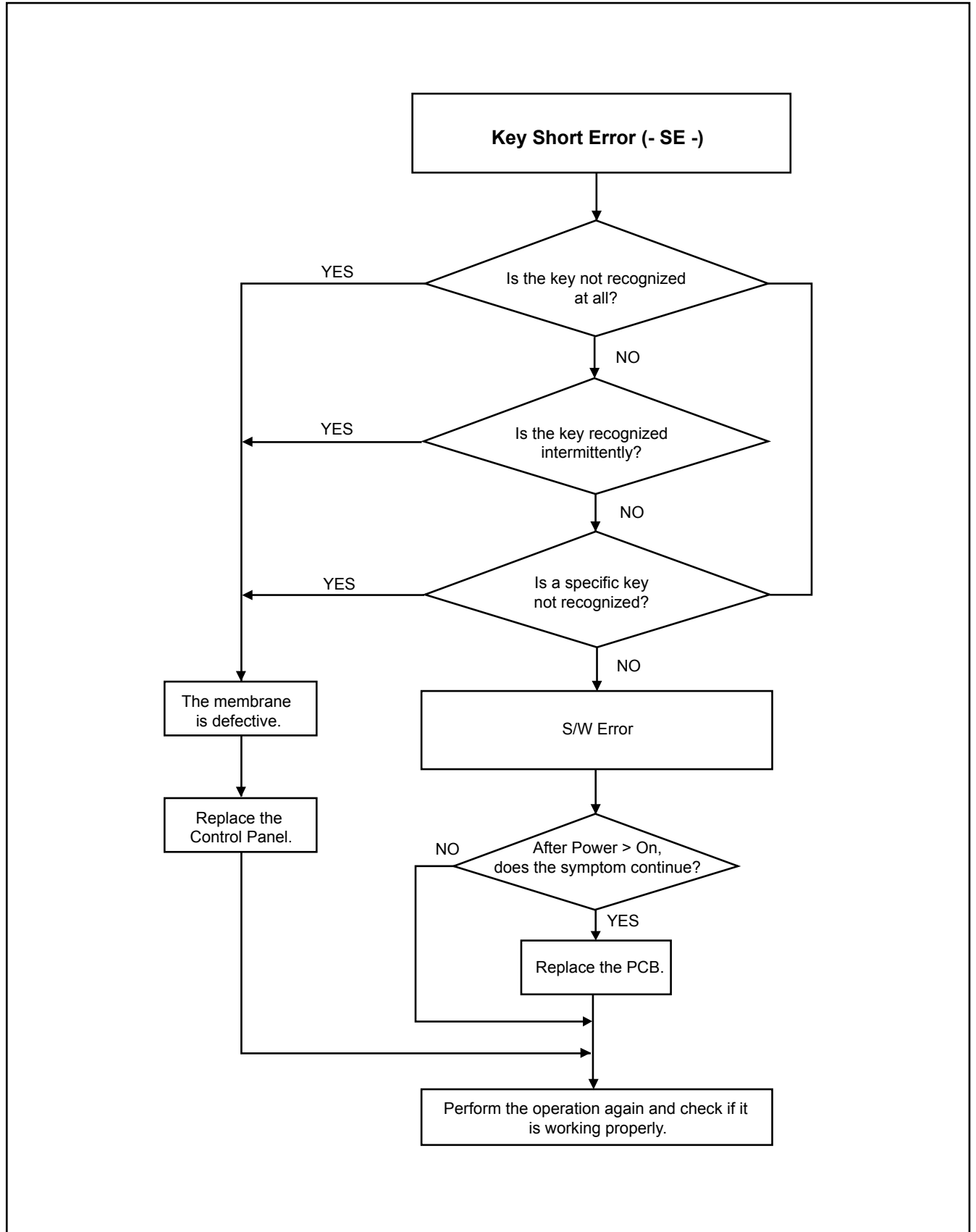

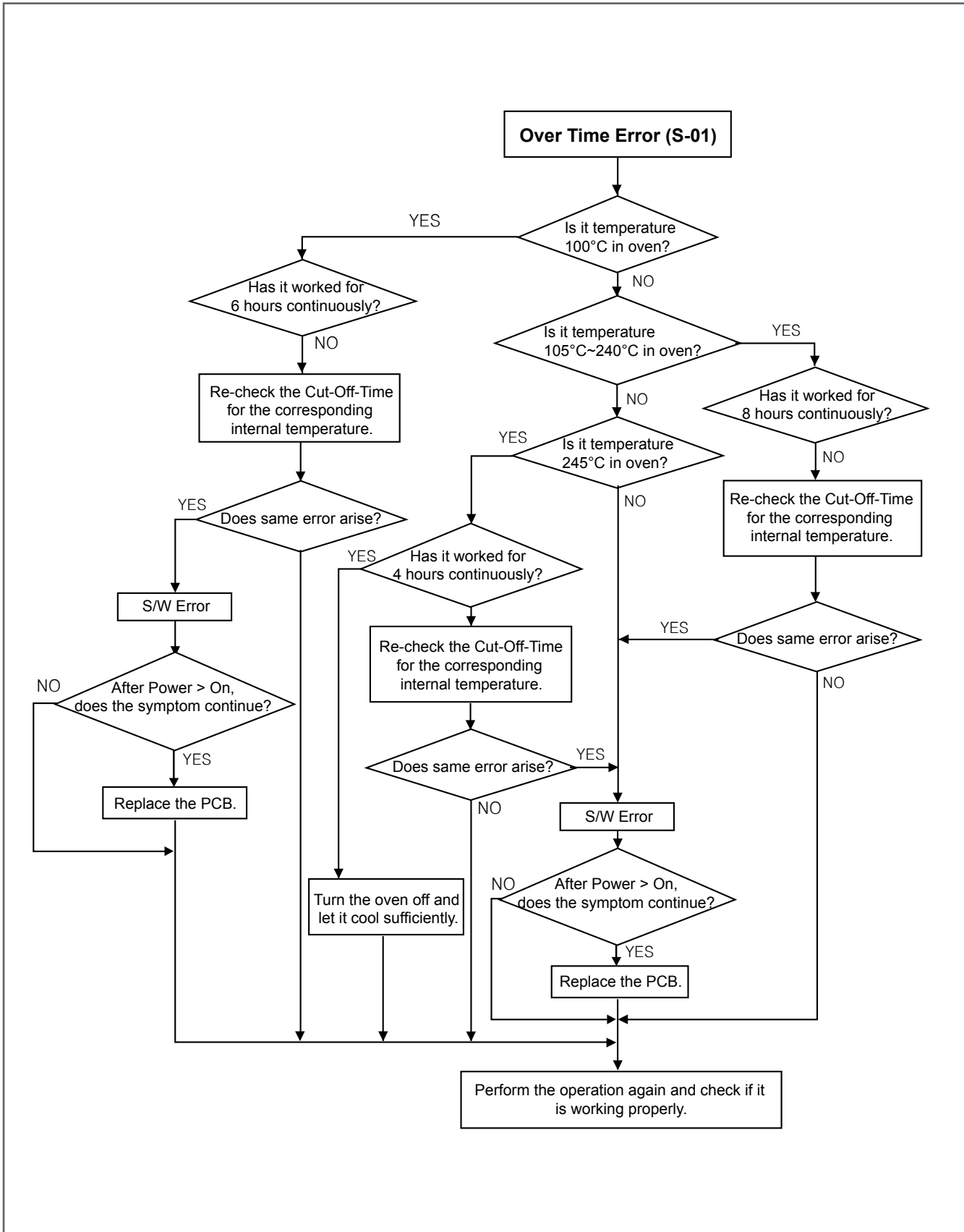

4-1-7 dE

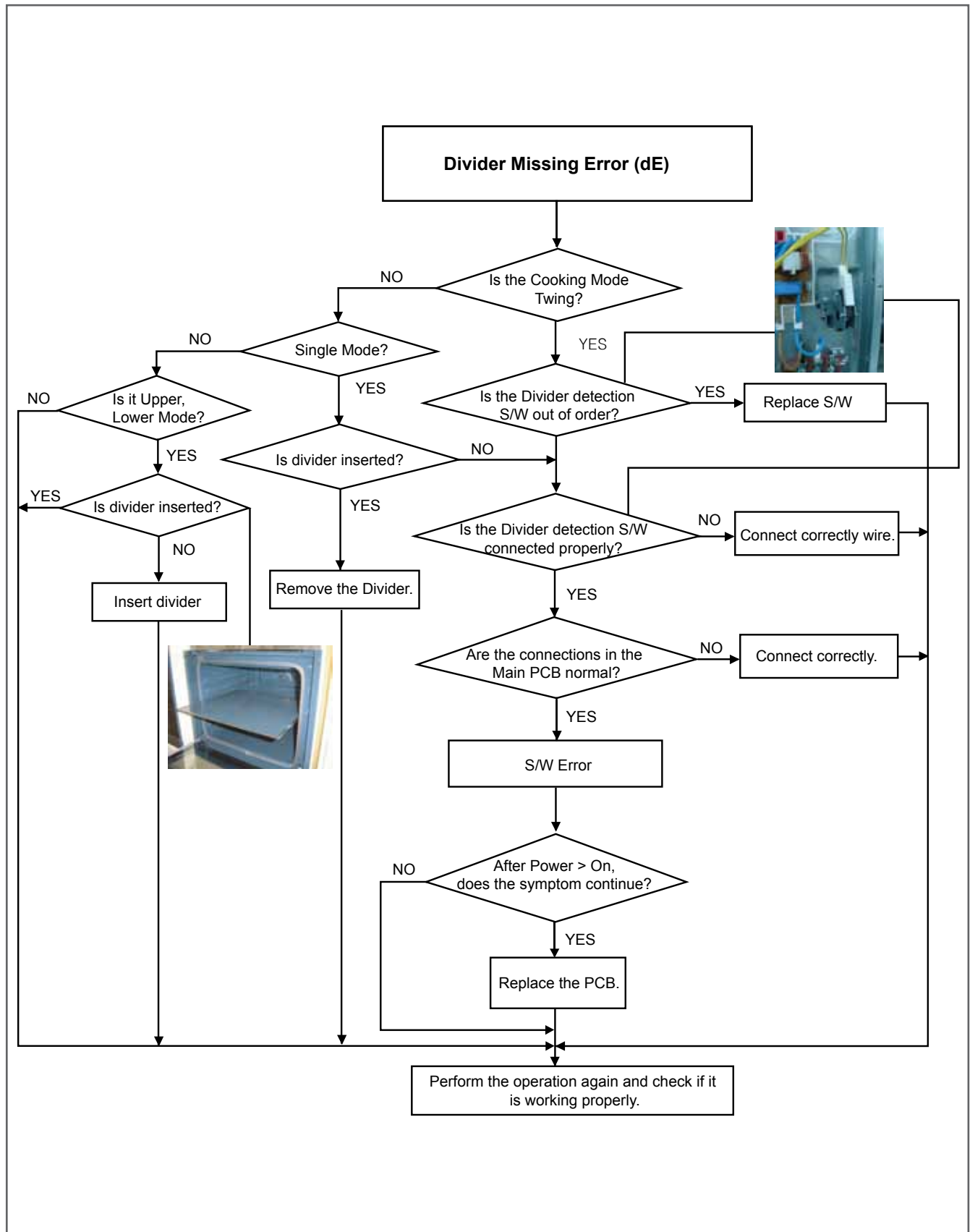

4-1-8 E-0b

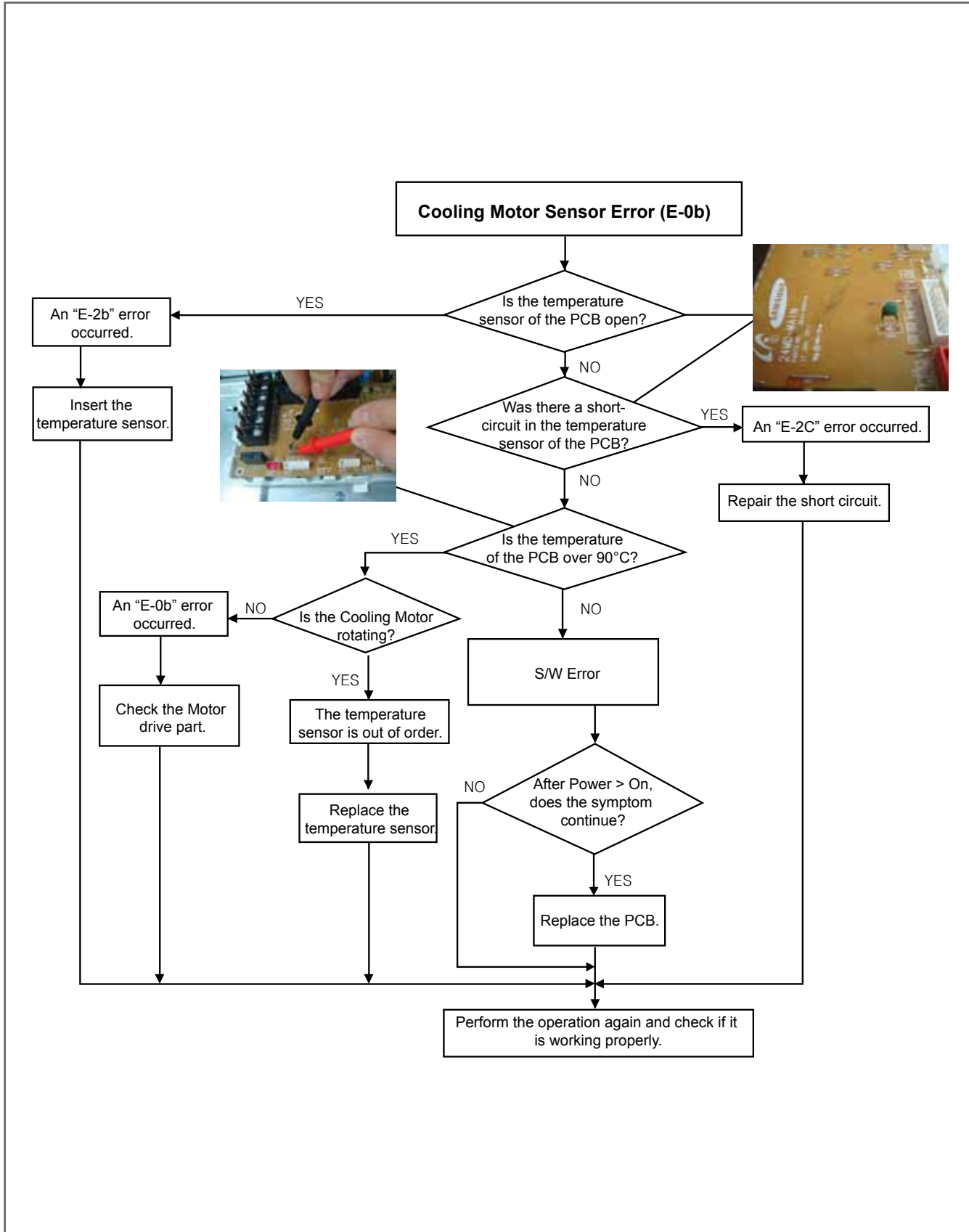

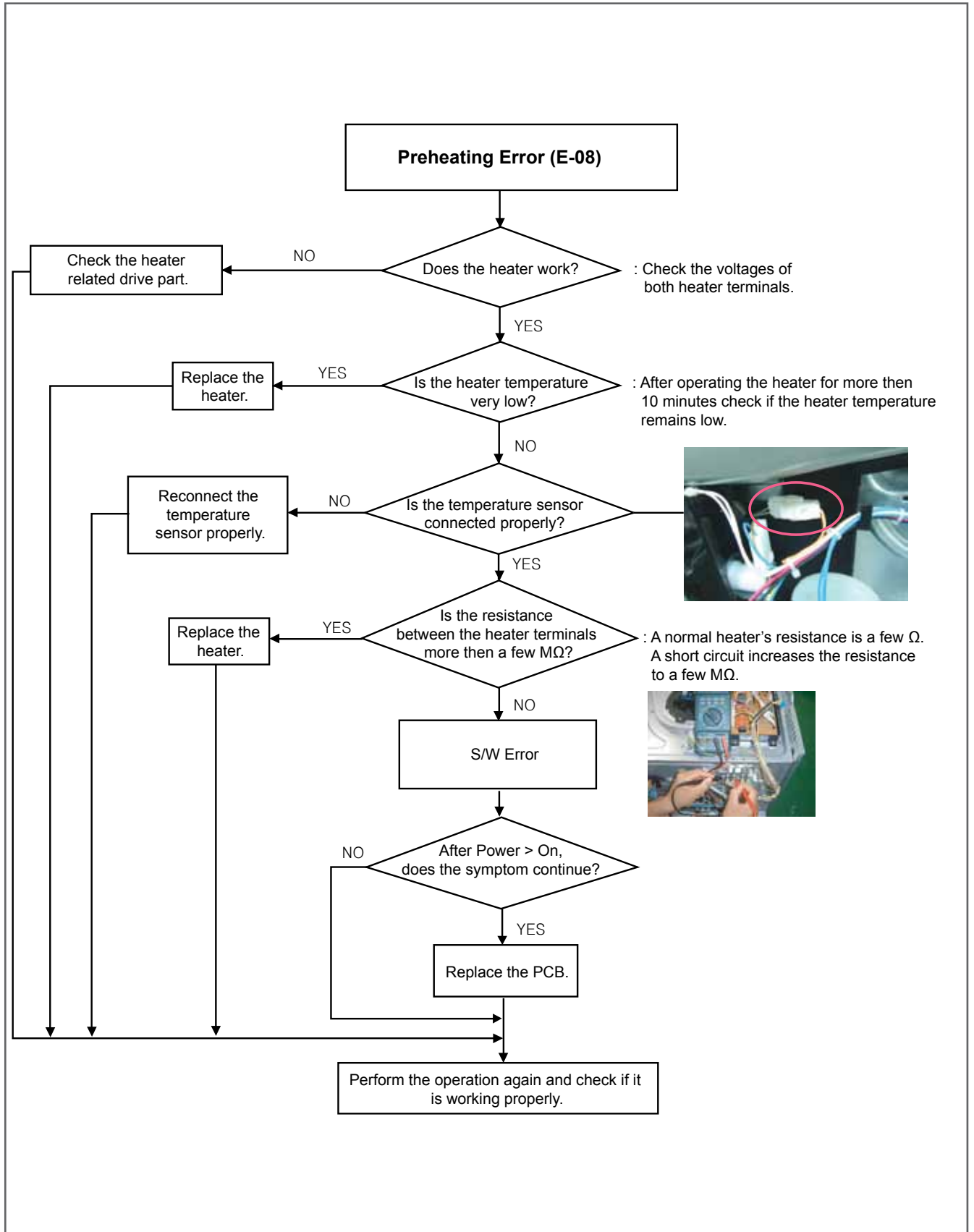

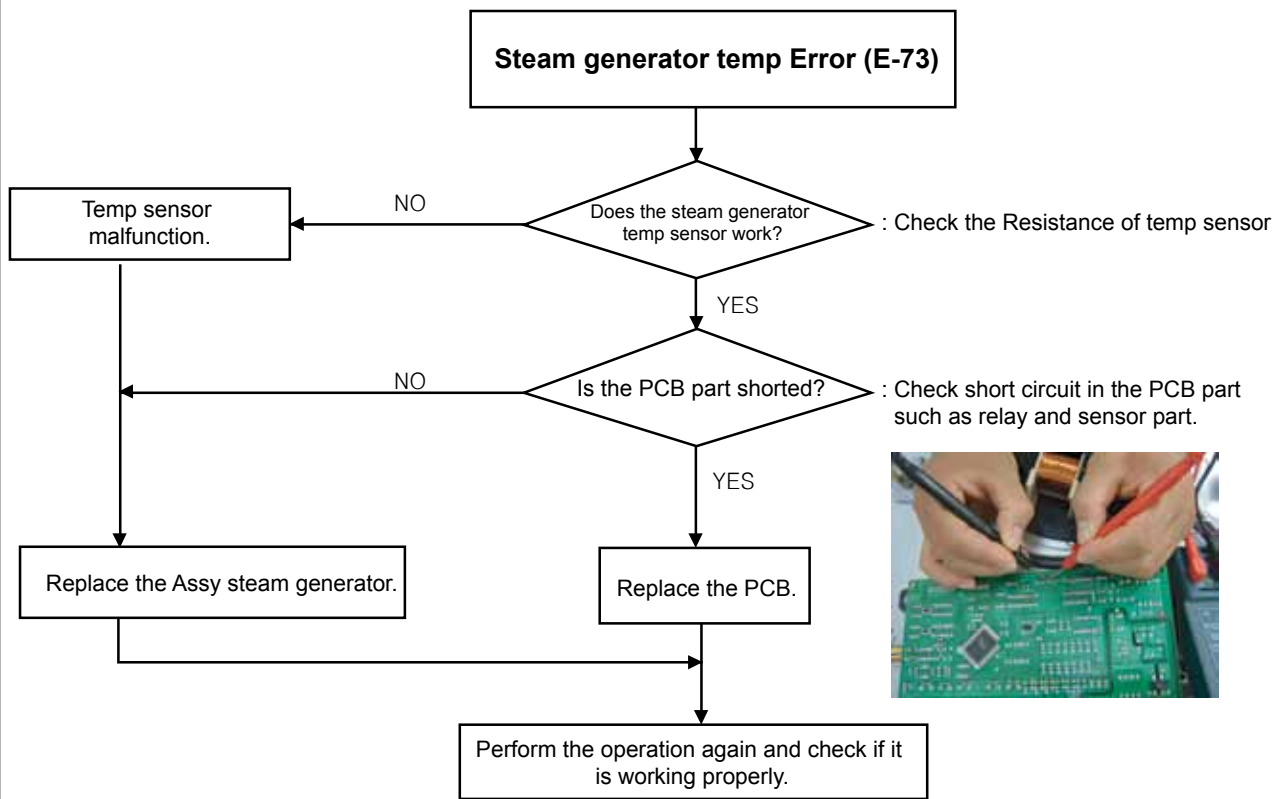

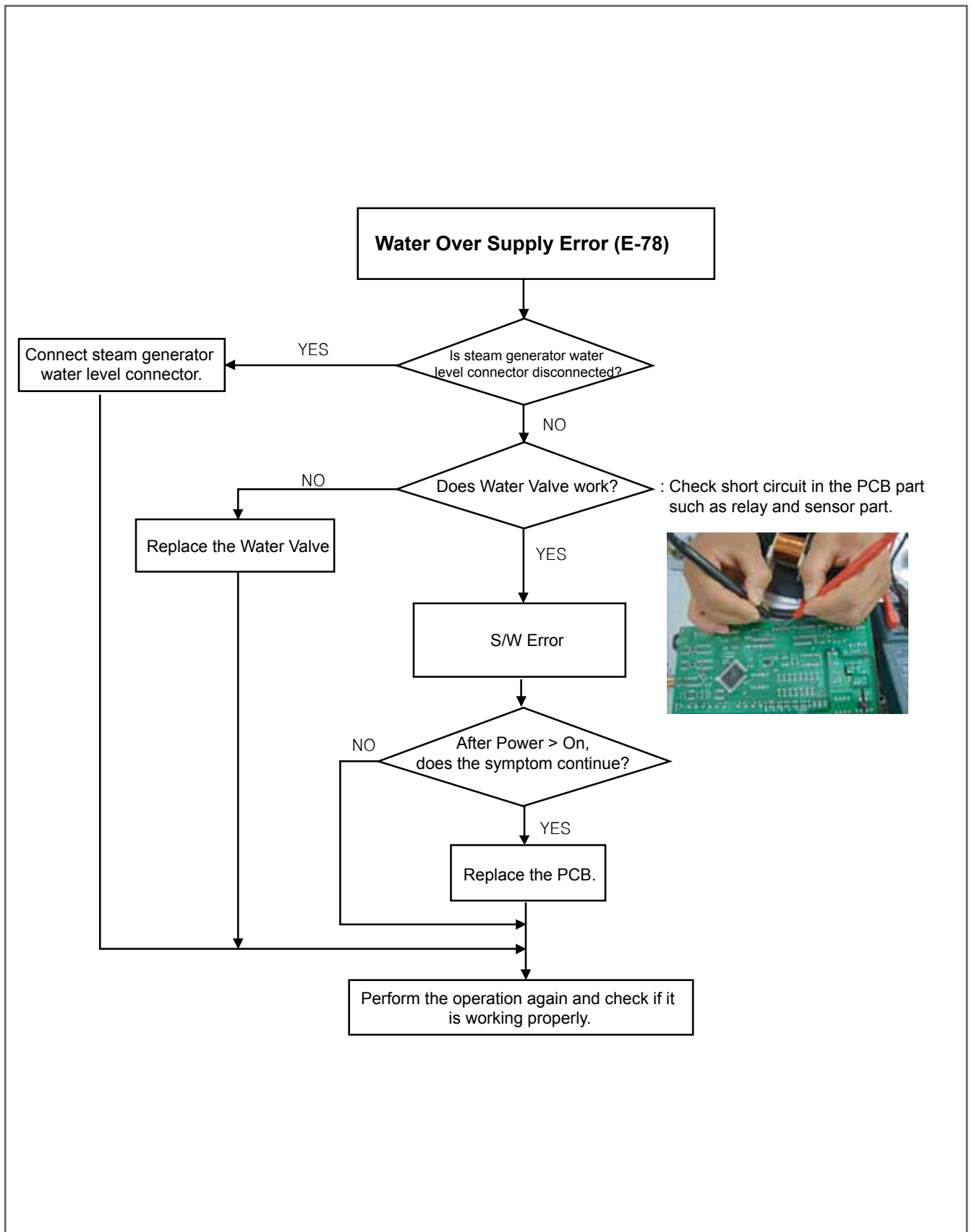

4-1-12 E-0A, E-09

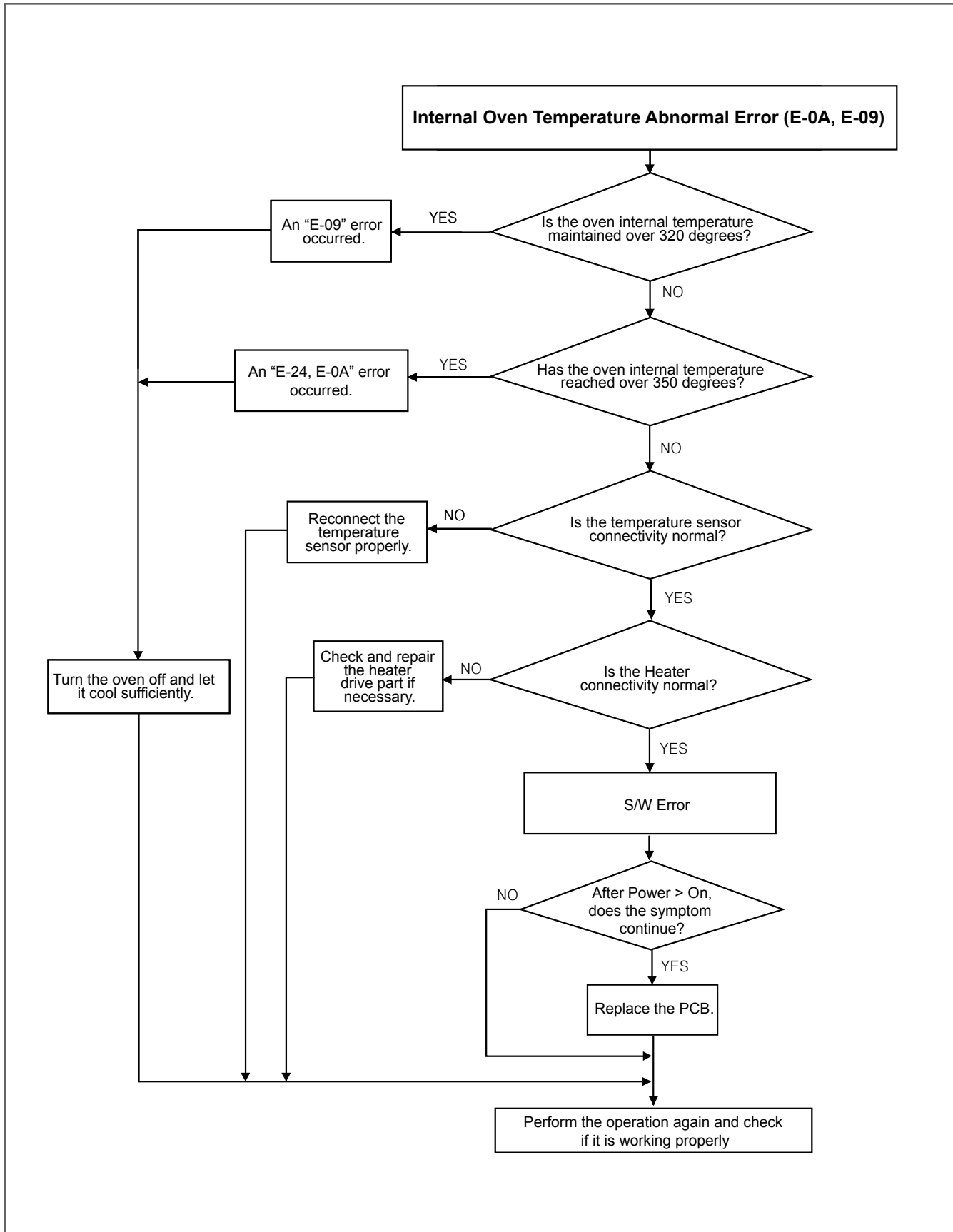

4-1-13 Power Failure

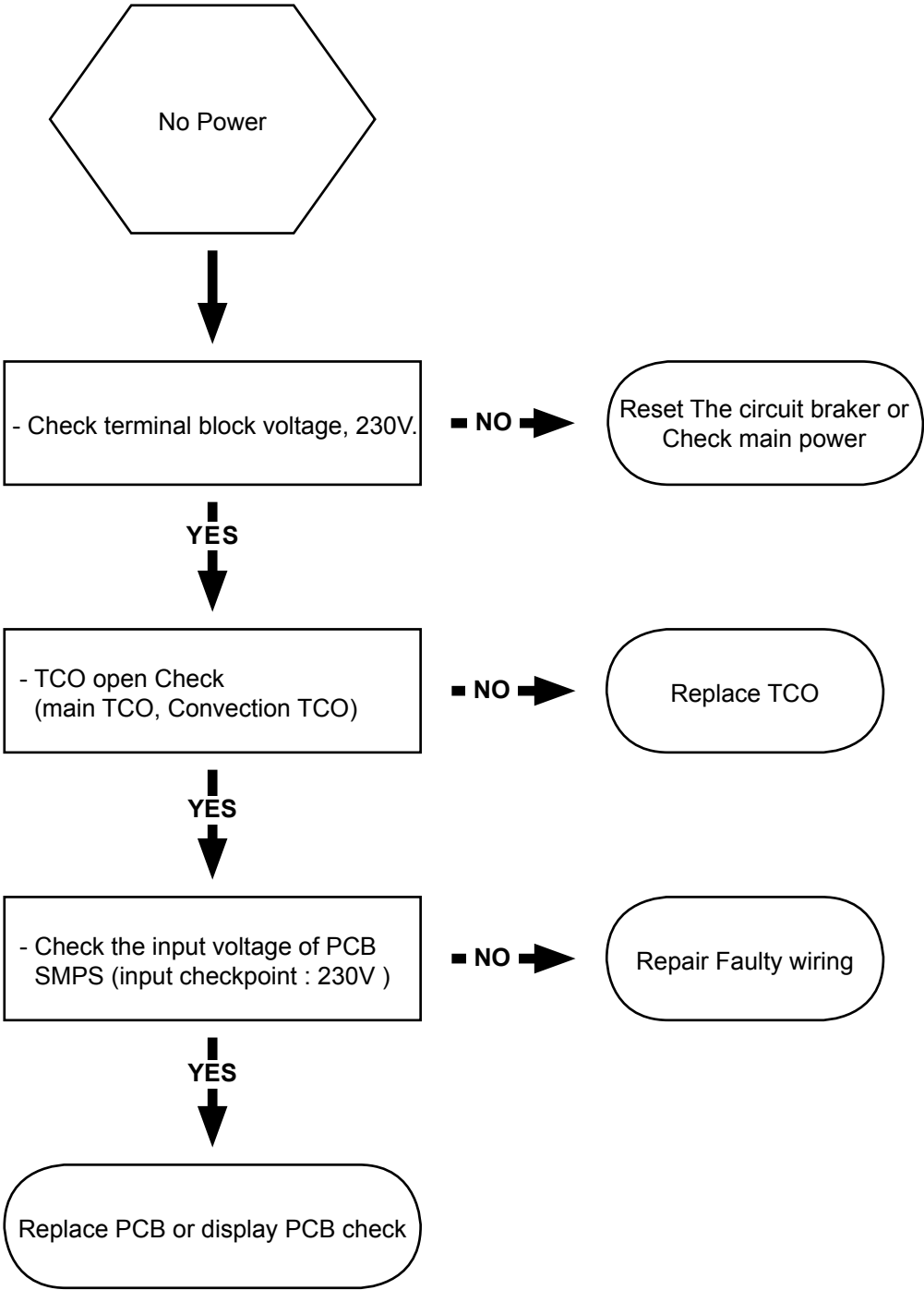

4-1-14 TCO Open

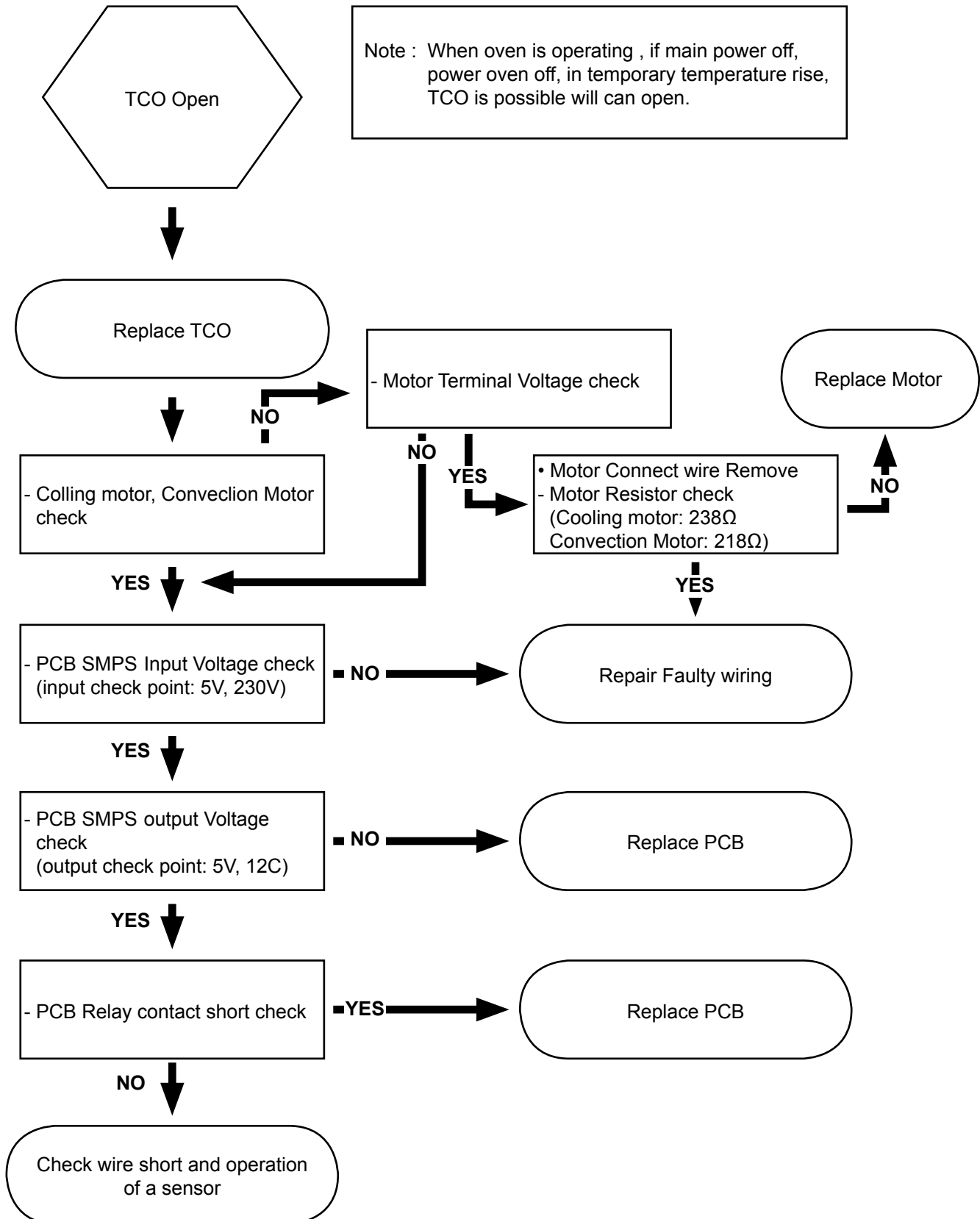

4-1-15 PCB Failure

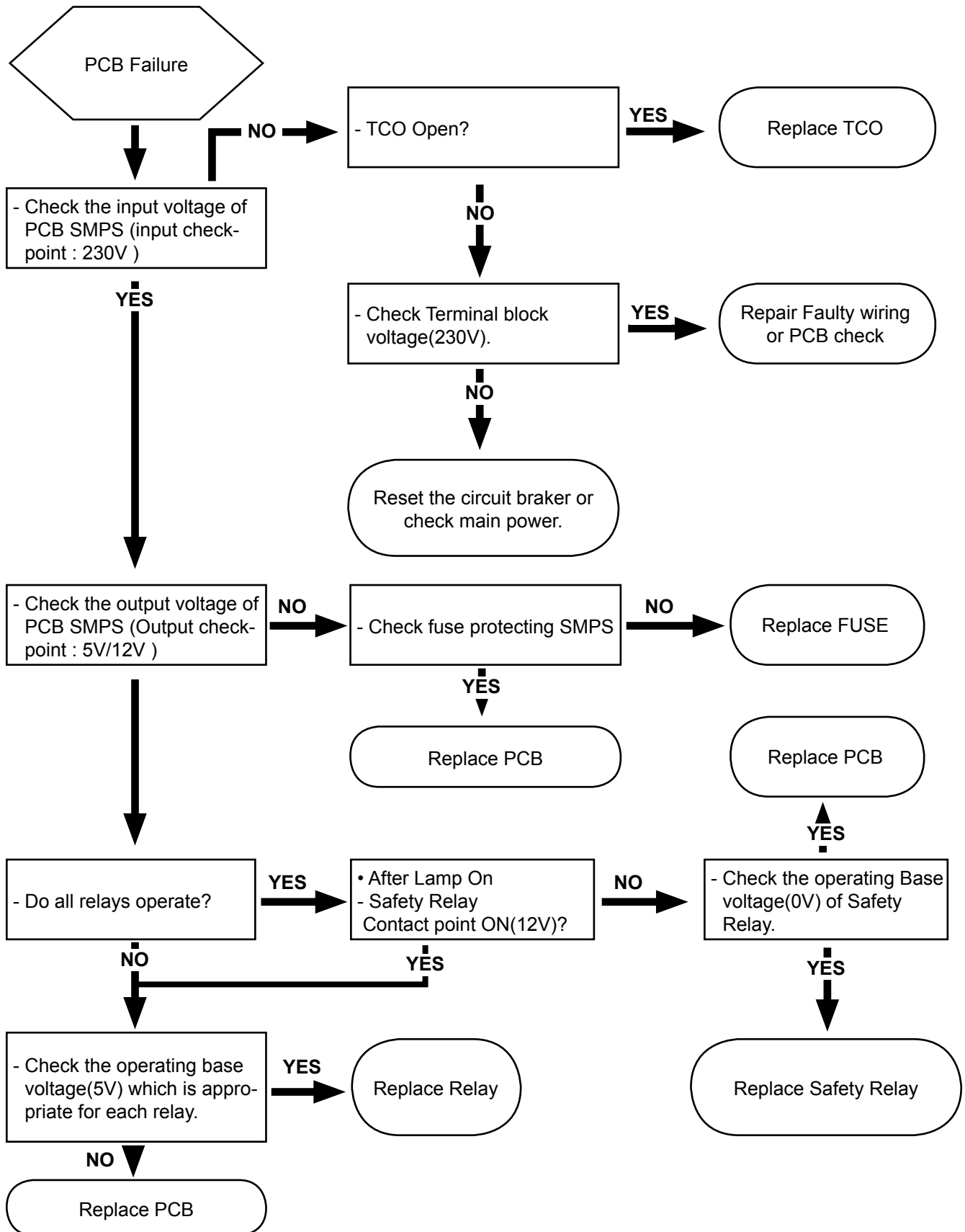

4-1-16 Failure of heating elements

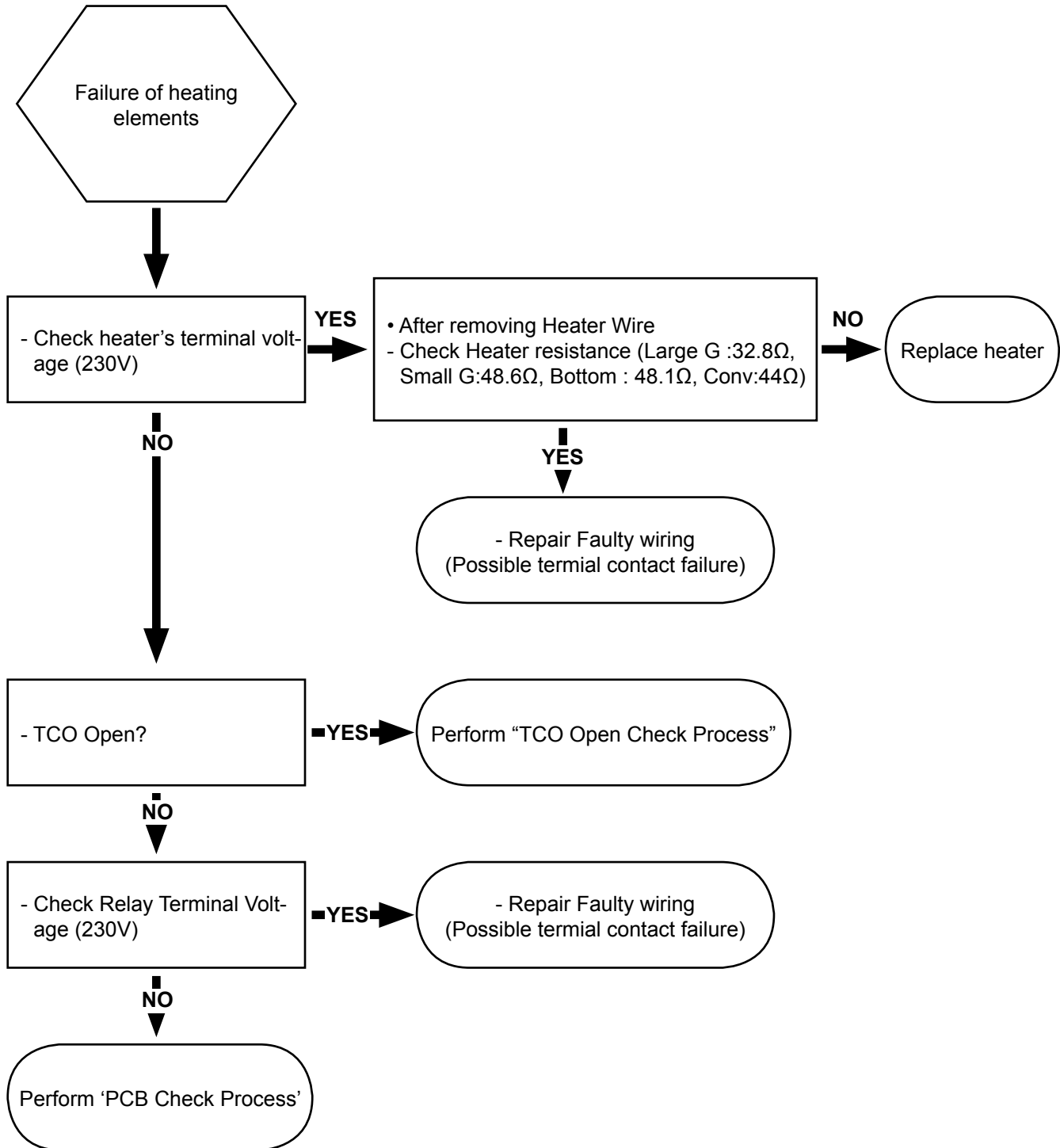

5. Exploded Views and Parts List

5-1 Exploded Views

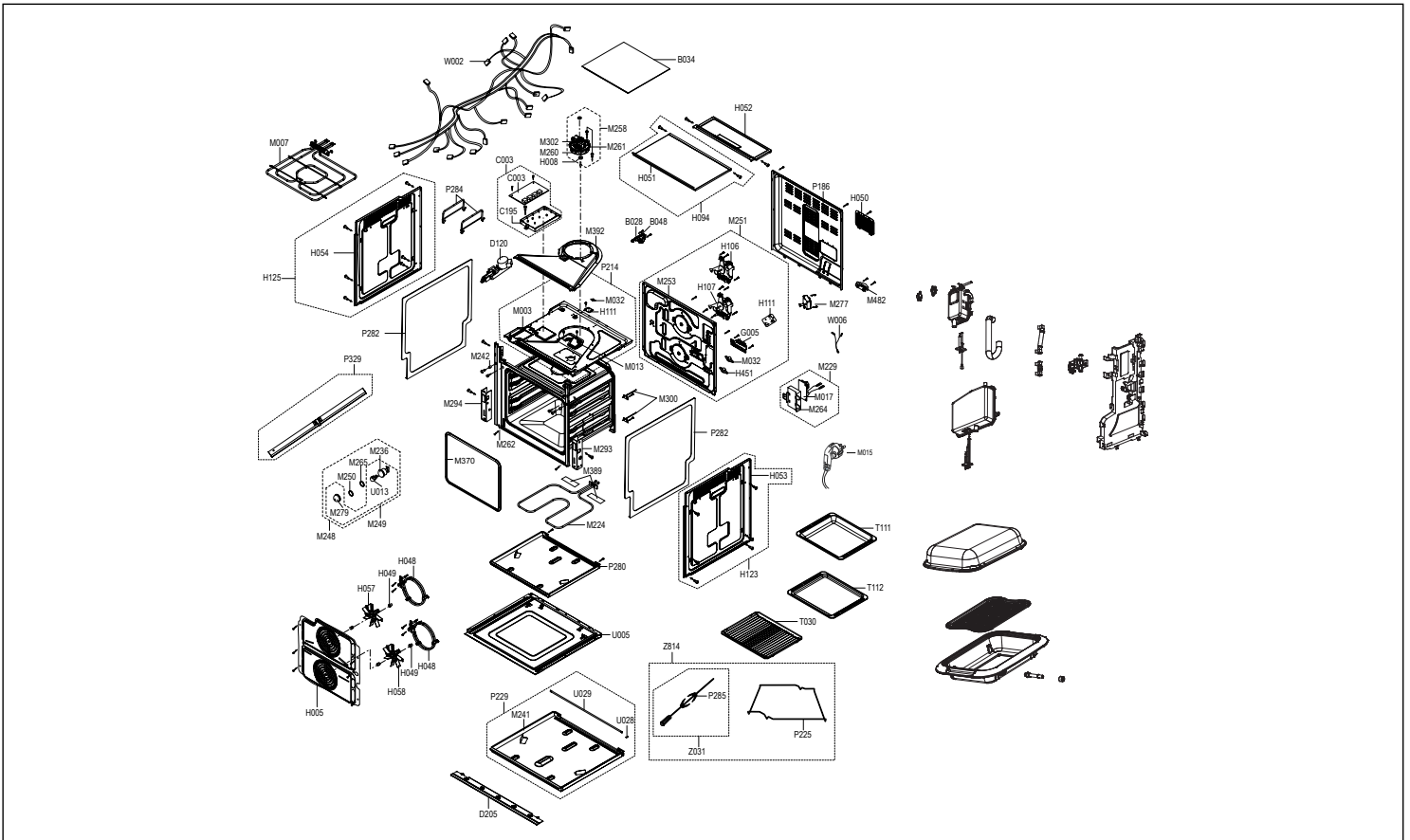

5-3 Door Parts List

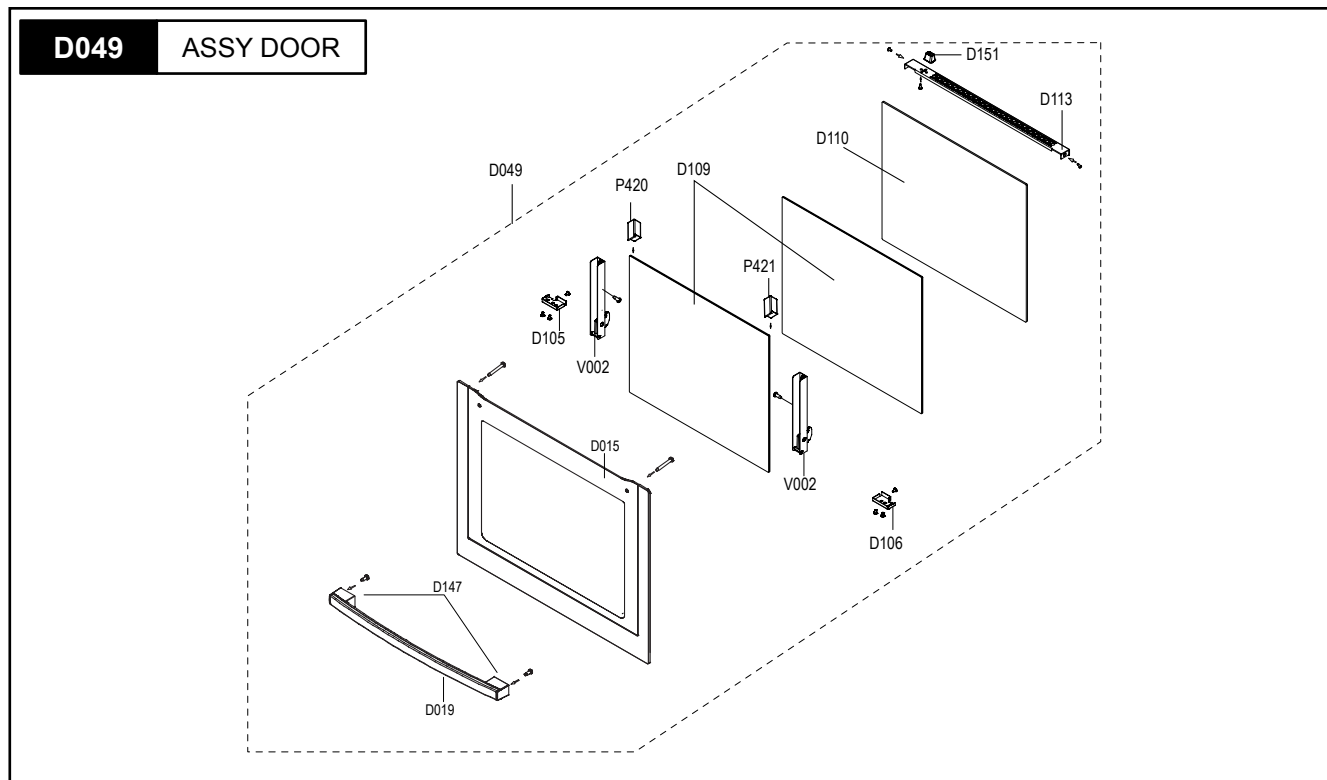

(SNA : SERVICE NOT AVAILABLE)

No.	Code No.	Description	Specification	Q'ty	SA/SNA	Remark

5-4 Control Parts List

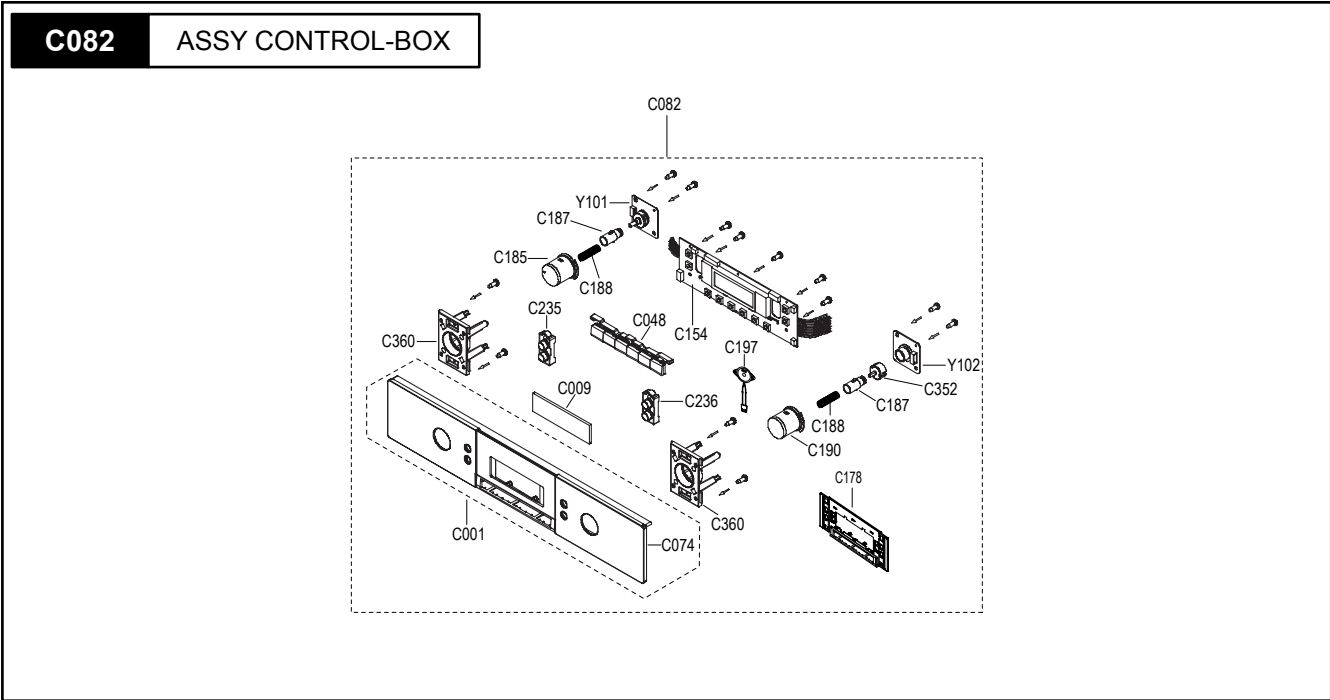

(SNA : SERVICE NOT AVAILABLE)

No.	Code No.	Description	Specification	Q'ty	SA/ SNA	Remark

6. PCB Diagram

6-1 PCB Diagram

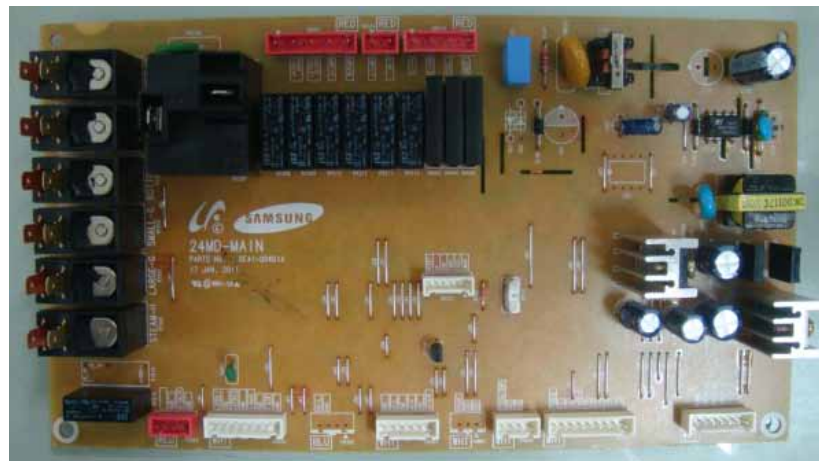

No.	Parts Number	Part Name	Function and Rule	No.	Parts Number	Part Name	Function and Rule
1	CN101	Display connector-1	A Terminal for Connecting with display module.	12	RY104	Upper heater Relay	A relay for Connecting with Upper heater
2	CN102	Display connector-2	A Terminal for Connecting with display module.	13	RY105	Lower heater Relay	A relay for Connecting with Lower heater
3	CN103	Temp sensor & divider switch connector	A Terminal for Connecting with divider and temp sensor.	14	RY106	Latch open Relay	Latch open control
4	CN104	Buzzer	A Terminal for Connecting with speaker.	15	RY107	Latch close Relay	Latch close control
5	CN105	Door Lock motor connector	A Terminal for Connecting with Door Lock motor.	16	RY108	Uppwe lamp Relay	Uppwe lamp control
6	CN106	Neutral , upper/lower lamp	A Terminal for Connecting with Neutral,upper/lower lamp.	17	RY109	Lower lamp Relay	Lower lamp control
7	CN107	Spit , Upper/lower fan , Cooling fan	A Terminal for Connecting with Spit , Upper/lower fan , Cooling fan.	18	RY111	Spit Relay	Spit Source
8	CN108	Door latch , Door sensing	A Terminal for Connecting with Door latch , Door sensing	19	RY112	Source Relay	Supply power for all relay
9	RY101	Large grill Relay	A relay for Connecting with Large grill heater	20	SSR101	Upper fan SSR	Upper fan control
10	RY102	Small grill Relay	A relay for Connecting with Small grill heater	21	SSR102	Lower fan SSR	Lower fan control
11	RY103	Bottom heater Relay	A relay for Connecting with Bottom heater	22	SSR103	Cooling fan SSR	Cooling fan control

7. Wiring Diagram (This Document can not be used without Samsung's authorization.)

7-1 Wiring Diagram

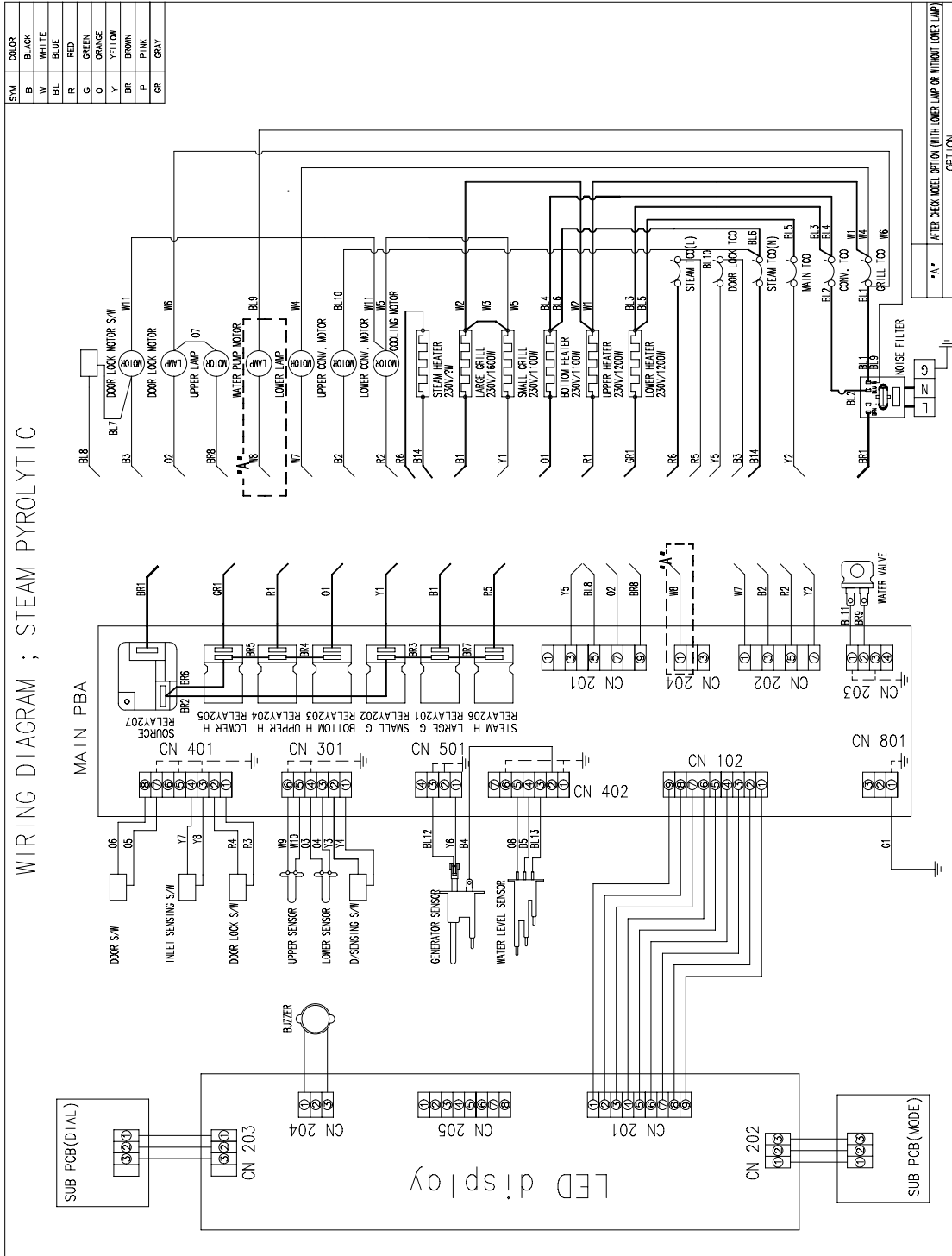

8. Schematic Diagram

8-1 Schematic Diagram

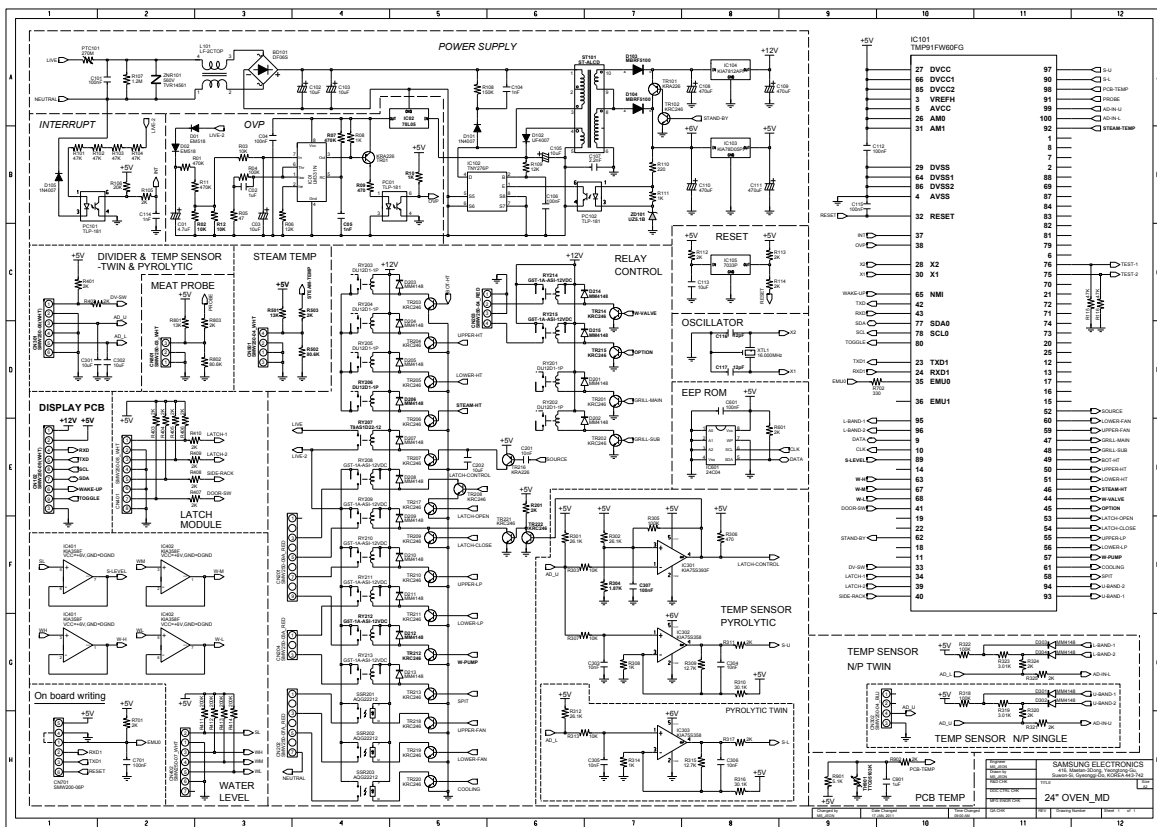



GSPN (Global Service Partner Network)

Contry	Web Site
North America	service.samsungportal.com
Latin America	latin.samsungportal.com
CIS	cis.samsungportal.com
Europe	europe.samsungportal.com
China	china.samsungportal.com
Asia	asia.samsungportal.com
Mideast & Africa	mea.samsungportal.com

**This Service Manual is a property of Samsung Electronics Co.,Ltd.
Any unauthorized use of Manual can be punished under applicable
International and/or domestic law.**

© Samsung Electronics Co., Ltd. April
2011 Printed in Korea