

vue de l'avant

vue de l'arrière

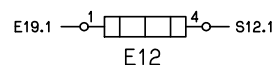

- A1 minuterie
- E12 résistance de sole 1100W/230V
- E17 résistance grilloir 1300W/230V
- E19 résistance circulaire 1600W/230V
- E24 éclairage du four 40W
- E27 résistance grilloir 1500W/230V
- K4 relais de puissance
- M1 ventilateur
- M3 turbine de ventilation
- M9 moteur de la broche tournante
- N8 thermostat du four
- N13 thermost. du ventilat. de refroidissem.
- N15 limiteur de température
- R33 résistance 750Ω
- S12 sélecteur
- X7 borne de branchement au réseau
- ⌘ alternatif (additionné ou non)

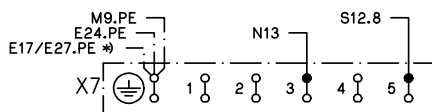
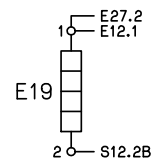
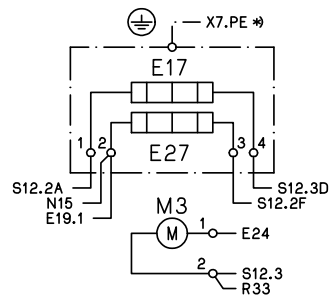
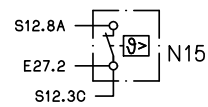
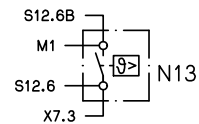
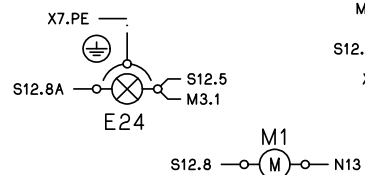
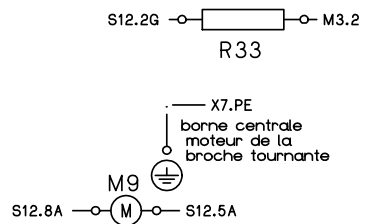

F

|                |            |
|----------------|------------|
| 56500941758P01 | 14.02.2003 |
| HB 430250BF    | S0-30/4218 |