



LED TV

Chassis : U85A

Model : UE40F6320AW
UE46F6320AW
UE55F6320AW

SERVICE Manual

LED TV



UE**F6320AW

Contents

1. Precautions
2. Product specifications
3. Disassembly and Reassembly
4. Troubleshooting
5. Wiring Diagram

Contents

1. Precautions	1-1
1-1. Safety Precautions	1-1
1-1-1. Warnings.....	1-1
1-1-2. Servicing the LED TV	1-1
1-1-3. Fire and Shock Hazard	1-1
1-1-4. Product Safety Notices	1-2
1-2. Servicing Precautions.....	1-3
1-2-1. General Servicing Precautions	1-3
1-3. Static Electricity Precautions	1-4
1-4. Installation Precautions	1-5
2. Product Specifications	2-1
2-1. Product information	2-1
2-2. Product specification	2-2
2-2-1. Detailed Specifications	2-2
2-2-2. Feature & Specifications.....	2-6
2-3. Accessories	2-9
2-4. Viewing the Functions	2-10
2-4-1. Auto Motion Plus 120 Hz	2-10
2-4-2. Supported Formats	2-11
2-4-3. Remote Control	2-13
2-4-4. Universal Remote Control Setup	2-14
2-4-5. SMART HUB.....	2-15
2-4-6. 3D Display	2-17
3. Disassembly and Reassembly	3-1
3-1. Disassembly and Reassembly	3-1
3-1-1. LED TV	3-1
3-1-2. ASSY BOARD P-RF-MODULE.....	3-9
3-1-3. NETWORK	3-9
4. Troubleshooting	4-1
4-1. Troubleshooting	4-1
4-1-1. Previous Check	4-1
4-1-2. Simple flow chart of malfunction.....	4-3
4-2. How to Check Fault Symptom	4-4
4-2-1. NO Power	4-4
4-2-2. No Video (HDMI 1, 2, 3, 4 - Digital Signal)	4-7
4-2-3. No Video (Tuner_CVBS)	4-10
4-2-4. No Vido (Tuner DTV)	4-13
4-2-5. No Video (Video AV)	4-16
4-2-6. No Video (COMPONENT)	4-19
4-2-7. No Sound (1.Speaker 2.Monitor_out 3.Optical).....	4-22

4-3. Factory Mode Adjustments	4-26
4-3-1. Detail Factory Option	4-26
4-3-2. Entering Factory Mode	4-27
4-3-3. Factory Data	4-28
4-4. White Balance	4-41
4-4-1. Calibration	4-41
4-4-2. Service Adjustment	4-41
4-4-3. Adjustment	4-42
4-5. RS-232C	4-43
4-6. AV Control Tab	4-44
4-7. Software Upgrade	4-50
4-7-1. How to Check the Software Version	4-50
4-7-2. How to Upgrade Software	4-51
5. Wiring Diagram	5-1
5-1. Wiring Diagram	5-1
5-2. Connector	5-2
5-3. Connector Functions	5-4



**This Service Manual is a property of Samsung Electronics Co.,Ltd.
Any unauthorized use of Manual can be punished under applicable
International and/or domestic law.**

**© 2013 Samsung Electronics Co.,Ltd.
All rights reserved.
Printed in Korea**

3. Disassembly and Reassembly

This section of the service manual describes the disassembly and reassembly procedures for the LED TV.



This LED TV contains electrostatically sensitive devices. Use caution when handling these components.

3-1. Disassembly and Reassembly





1. Disconnect the LED TV from the power source before disassembly.
2. Follow these directions carefully; never use metal instruments to pry apart the cabinet.
3. If there is no additional coment, it is same for all inches.



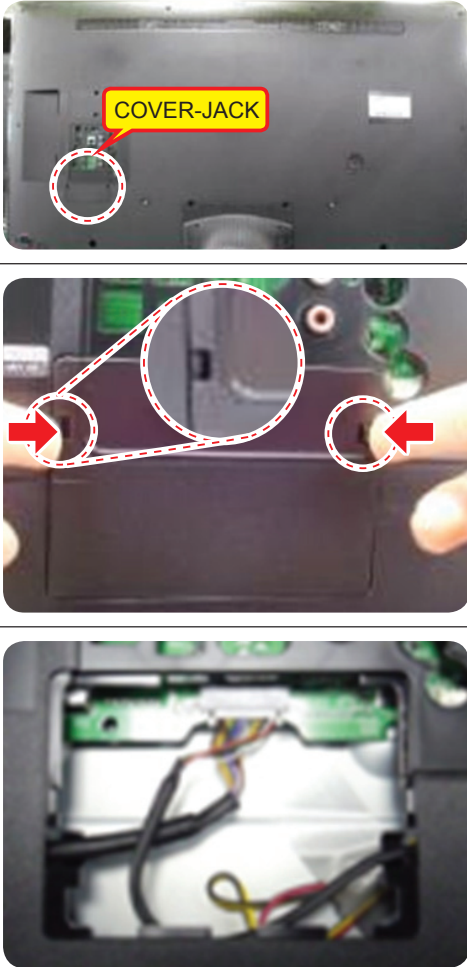
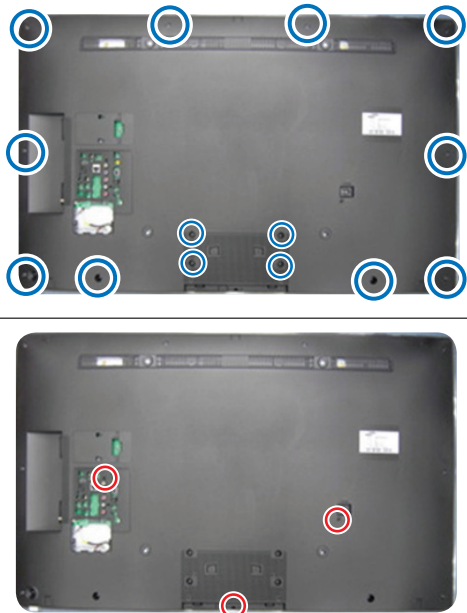

3-1-1. LED TV

■ 40 / 46 Inches



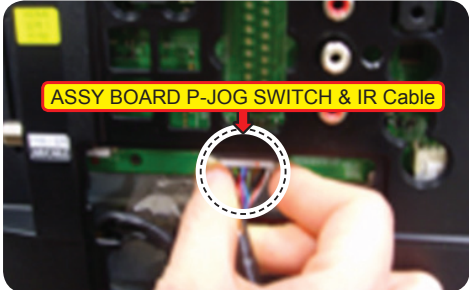

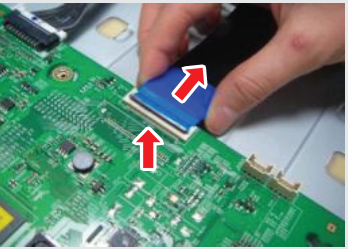
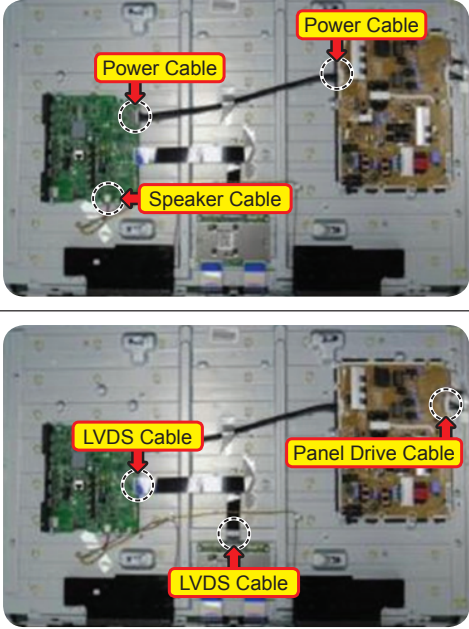
Description	Picture Description	Screws
<p>1 Place TV face down on cushioned table.</p>		
<p>2 Remove 4 screws from the ASSY GUIDE P-STAND.</p>		<p>Torque : 9~11Kgf.cm. 128~156psi</p> <p>6003-001782 SCREW-MACHINE M4.0, L12.0 BLK</p>
<p>3 Remove STAND.</p>		

3. Disassembly and Reassemble

Description	Picture Description	Screws
<p>4 Remove the COVER-JACK after push the locking in both sides.</p>		
<p>5 Remove screws of ASSY COVER P-MIDDLE, REAR.</p> <ul style="list-style-type: none"> • 40 inch : 14 EA • 46 inch : 14 EA <ul style="list-style-type: none"> • 40 inch : 2 EA • 46 inch : 3 EA 		<div style="display: flex; flex-direction: column; align-items: center;"> <div style="text-align: center;">  <p>Torque : 7~8Kgf.cm. 100~113psi</p> </div> <div style="text-align: center;"> <p>6001-002755 SCREW-MACHINE M3.0, L6.0 BLK</p> </div> <div style="text-align: center; margin-top: 20px;">  <p>Torque : 9~11Kgf.cm. 128~156psi</p> </div> <div style="text-align: center;"> <p>6003-001782 SCREW-MACHINE M4.0, L12.0 BLK</p> </div> </div>

Description	Picture Description	Screws
<p>6 Disconnect the ASSY BOARD P-JOG SWITCH & IR Cable.</p> <p> NOTE First remove the cable before you remove the ASSY COVER P-MIDDLE, REAR.</p>	 <p>ASSY BOARD P-JOG SWITCH & IR Cable</p>	
<p>7 Remove the ASSY COVER P-MIDDLE, REAR.</p>		
<p>8 Remove the Power Cables and Speaker Cables. Remove the LVDS Cable and Panel Drive Cable.</p> <p> NOTE Applied to Double locking.</p> <ol style="list-style-type: none"> 1. Flip up the locking tab on top of the connector. 2. Squeeze the edge of the connector to release the second tab lock and gently pull the connector away. 	 <p>Power Cable</p> <p>Power Cable</p> <p>Speaker Cable</p> <p>LVDS Cable</p> <p>Panel Drive Cable</p> <p>LVDS Cable</p>	
<p>9 Remove the screws of ASSY PCB MAIN.</p>		<p>Torque : 7~8Kgf.cm. 100~113psi</p>  <p>6001-002756 SCREW-MACHINE M3.0, L6.0 WHT</p>

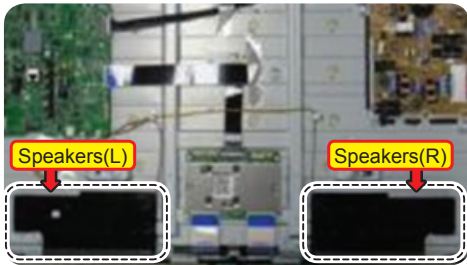
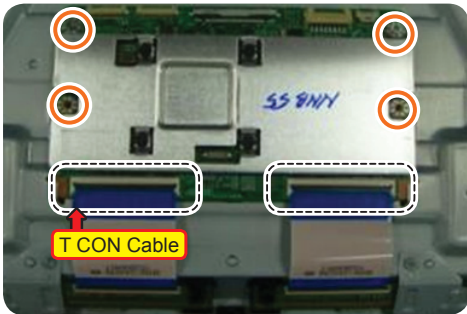
3. Disassembly and Reassemble







Description	Picture Description	Screws
<p>10 Remove the screws of DC VSS-LED TV PD BD.</p>		<p>Torque : 7~8Kgf.cm. 100~113psi</p>  <p>6001-002756 SCREW-MACHINE M3.0, L6.0 WHT</p>
<p>11 Remove the ASSY SPEAKER (L/R).</p>		
<p>12 Remove the 4 screws of ASSY T CON and unlock the locking of T CON Cable.</p>		<p>Torque : 7~8Kgf.cm. 100~113psi</p>  <p>6001-002756 SCREW-MACHINE M3.0, L6.0 WHT</p>
<p>13 Completed disassembly.</p> <ul style="list-style-type: none"> Panel. 		



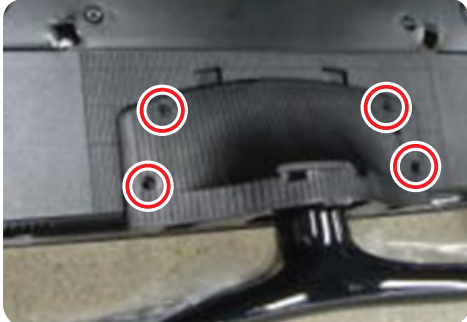





NOTE



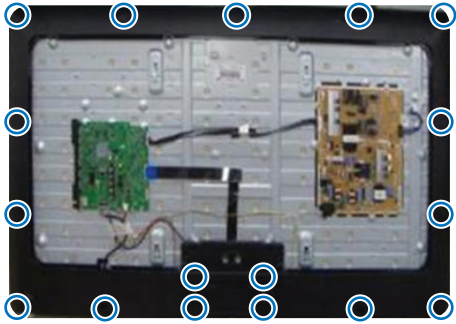

Reassembly procedures are in the reverse order of disassembly procedures.

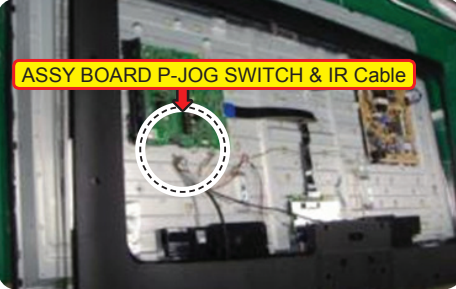
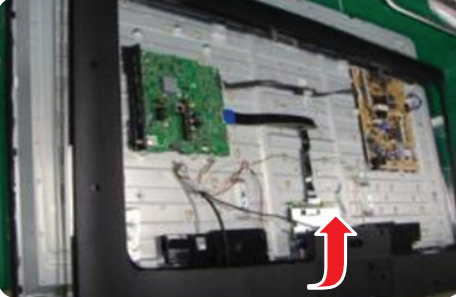
■ 55 Inches

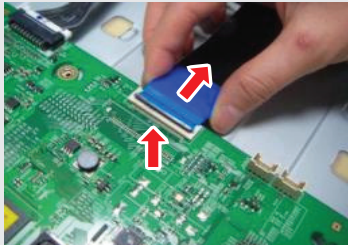
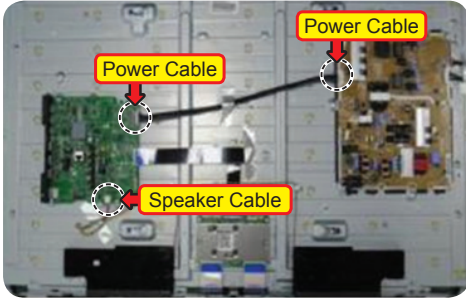
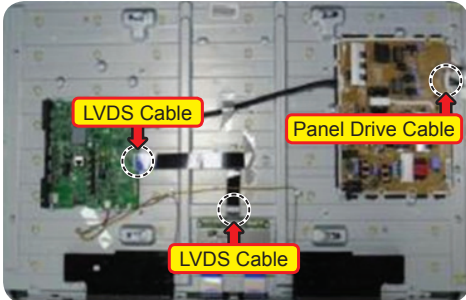

Description	Picture Description	Screws
<p>1 Place TV face down on cushioned table.</p>		
<p>2 Remove 4 screws from the ASSY GUIDE P-STAND.</p>		<p>Torque : 9~11Kgf.cm. 128~156psi</p>  <p>6003-001782 SCREW-MACHINE M4.0, L12.0 BLK</p>
<p>3 Remove STAND.</p>		
<p>4 Remove screws of ASSY COVER P-REAR.</p> <ul style="list-style-type: none"> • 55 inch : 4 EA 		<p>Torque : 7~8Kgf.cm. 100~113psi</p>  <p>6001-002755 SCREW-MACHINE M3.0, L6.0 BLK</p>
<ul style="list-style-type: none"> • 55 inch : 4 EA 		<p>Torque : 9~11Kgf.cm. 128~156psi</p>  <p>6003-001782 SCREW-MACHINE M4.0, L12.0 BLK</p>

3. Disassembly and Reassemble

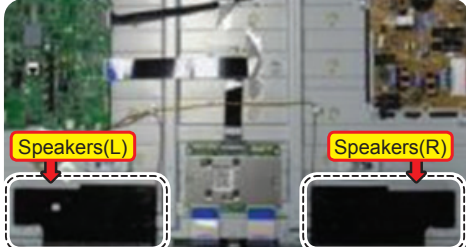
Description	Picture Description	Screws
<p>5 Remove 17 screws of ASSY COVER P-MIDDLE.</p>		<p>Torque : 7~8Kgf.cm. 100~113psi</p>  <p>6001-002755 SCREW-MACHINE M3.0, L6.0 BLK</p>
<p>Remove 1 screws of ASSY COVER P-MIDDLE.</p> <p>! CAUTION Be careful when you lift up the ASSY COVER P-MIDDLE, It's really sharp.</p>		<p>Torque : 9~11Kgf.cm. 128~156psi</p>  <p>6003-001782 SCREW-MACHINE M4.0, L12.0 BLK</p>
<p>6 Disconnect the ASSY BOARD P-JOG SWITCH & IR Cable.</p> <p>NOTE First remove the cable before you remove the ASSY COVER P-MIDDLE.</p>	 <p>ASSY BOARD P-JOG SWITCH & IR Cable</p>	
<p>7 Lift up the ASSY COVER P-MIDDLE.</p>		
<p>8 Remove the ASSY COVER P-MIDDLE.</p>		

Description	Picture Description	Screws
<p>9 Remove the Power Cables and Speaker Cables. Remove the LVDS Cable and Panel Drive Cable.</p> <p> NOTE Applied to Double locking.</p> <ol style="list-style-type: none"> 1. Flip up the locking tab on top of the connector. 2. Squeeze the edge of the connector to release the second tab lock and gently pull the connector away. 	 	
<p>10 Remove the screws of ASSY PCB MAIN.</p>		 <p>Torque : 7~8Kgf.cm. 100~113psi</p> <p>6001-002756 SCREW-MACHINE M3.0, L6.0 WHT</p>
<p>11 Remove the screws of DC VSS-LED TV PD BD.</p>		 <p>Torque : 7~8Kgf.cm. 100~113psi</p> <p>6001-002756 SCREW-MACHINE M3.0, L6.0 WHT</p>
<p>12 Remove the ASSY SPEAKER (L/R).</p>		

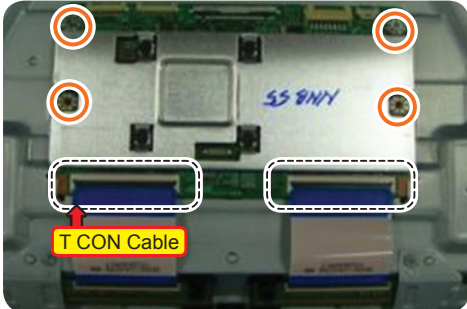
3. Disassembly and Reassemble

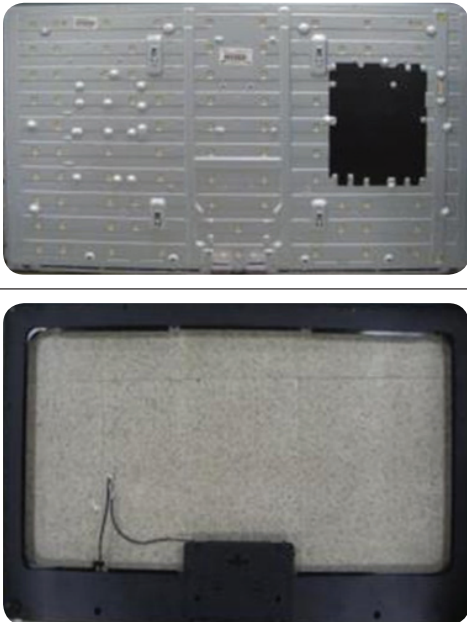
Description	Picture Description	Screws
<p>13 Remove the 4 screws of ASSY T CON and unlock the locking of T CON Cable.</p>		 <p>6001-002756 SCREW-MACHINE M3.0, L6.0 WHT</p>
<p>14 Completed disassembly.</p> <ul style="list-style-type: none"> Panel. ASSY COVER P-MIDDLE. 		



NOTE

Reassembly procedures are in the reverse order of disassembly procedures.

3-1-2. ASSY BOARD P-RF-MODULE

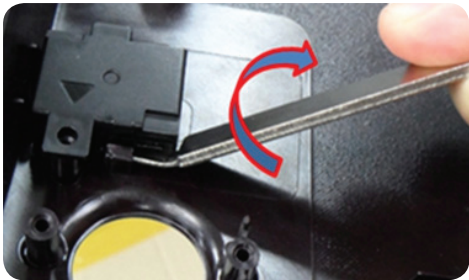
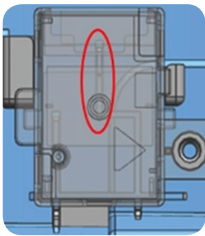
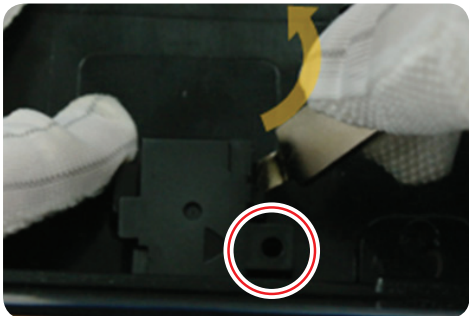
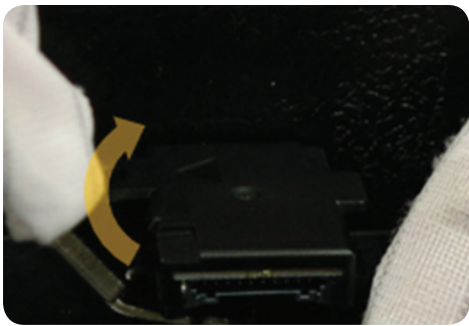
Description	Picture Description	Refer
<p>1 Preparation : BN81-00001A (Registered in Jig material)</p> 		
<p>2 Twist the jig after inserting ASSY BOARD P-RF-MODULE(B/T module) and ASSY COVER P-MIDDLE,REAR.</p>		
		

3-1-3. NETWORK

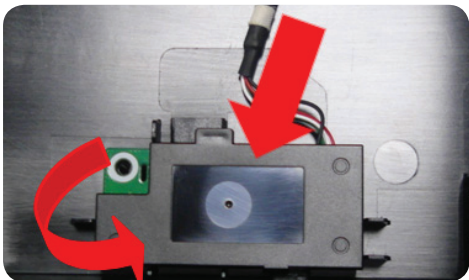
Description	Picture Description	Refer
<p>1 Remove the NETWORK(Wi-Fi module).</p>		

**NOTE**

Reassembly procedures are in the reverse order of disassembly procedures.

3. Disassembly and Reassemble

Screw Size

Code No.	COLOR	A (mm)	B (mm)	C (mm)	D (mm)	E (mm)	Screw Image
6003-001782	BLACK	7.80~8.20	1.85~1.95	3.81~3.91	11.4~12.0	-	
6001-002755	BLACK	7.1~7.5	1.9~2.0	2.98~3.02	5.7~6.0	4.4~5.4	
6001-002756	WHITE	5.6~6.0	1.15~1.25	2.92~2.98	3.7~4.0	4.4~5.4	

ANNEX. Exploded View & Part List [UE40F6320AWXXH UH02]

1-1. Exploded View

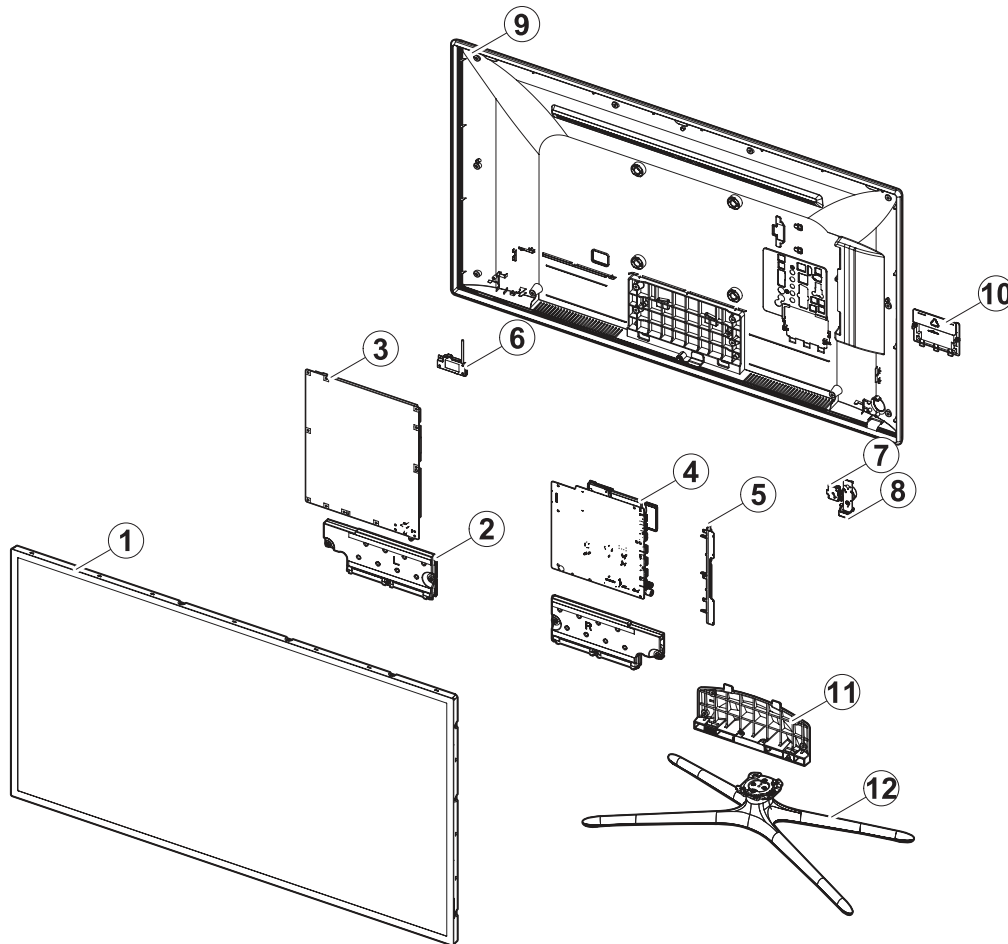

1-1-1. Part List

No.	Code No.	Description & Specification	Q'ty	SA/SNA	Remark
1	BN95-01110A	PRODUCT LCD-AMLCD; LSF400HJ01,CY-HF400CSL	1	SA	
2	BN96-25565A	ASSY SPEAKER P; 6ohm,10W,Enclosure_F6k	1	SA	
3	BN44-00622B	DC VSS-LED TV PD BD; L42X1Q_DHS,L42X1Q_DH	1	SA	
4	BN94-06624R	ASSY PCB MAIN; UE40F6320AWXXC	1	SA	
5	BN61-08813D	HOLDER-SIDE AV; F6100/6300,ABS+PC,WINERED	1	SNA	
6	BN59-01161A	NETWORK; WIDT-30Q,Internal WiFi,USB,IEEE8	1	SA	
7	BN96-25376A	ASSY BOARD P-RF-MODULE; Bluetooth Module,	1	SA	
8	BN96-26401E	ASSY BOARD P-JOG SWITCH & IR; UE40F6400,F	1	SA	
9	BN96-26634U	ASSY COVER P-MIDDLE,REAR; UF6320 40,PC V2	1	SA	
10	BN63-10178F	COVER-JACK; UF6100/6300 40"-50" EO,ABS+PC	1	SNA	
11	BN61-08823A	GUIDE-STAND; UF6100 55",PC+GF,G/F 20%	1	SA	
12	BN96-25547A	ASSY STAND P-BASE; UF6100 40,QUAD Chrome	1	SA	

2-1. Electrical Parts List

Service Bom (SA: SERVICE AVAILABLE, SNA: SERVICE NOT AVAILABLE)

Level	Location No.	Code No.	Description & Specification	Q'ty	SA/SNA	Remark
			UE40F6320AWXXH UH02			
1	S001A	BN90-04144A	ASSY STAND;LEDTV	1	SNA	
0.2	SG03	BN61-08823A	GUIDE-STAND;UF6100 55",PC+GF,G/F 20%	1	SA	
..3		0103-007285	RESIN-PC;MW32020GFU,K032202GFV,BK0007,V2	460	SNA	
0.2	SB04A	BN96-25547A	ASSY STAND P-BASE;UF6100 40,QUAD Chrome	1	SA	
..3		6002-001294	SCREW-TAPPING;BH,+.,M4,L16,ZPC(BLK)	4	SA	
..3	SCREW	6003-001315	SCREW-TAPTYPE;BH,+.,B,M4,L20,ZPC(WHT),SWR	4	SNA	
..3	SCREW	6003-001425	SCREW-TAPTYPE;BH,+.,B,M4,L25,ZPC(BLK),SWR	1	SNA	
..3	SCREW	6003-001785	SCREW-TAPTYPE;FH,+.,B,M4,L8,ZPC(BLK),SWRC	4	SA	
..3		BN61-07171C	HOLDER-SWIVEL, TOP;40 QUAD STAND,ACETAL,D	1	SNA	
..3		BN61-07175A	BRACKET-SWIVEL, TOP;UD8000 32/3740 QUAD,S	1	SNA	
..3		BN61-07738A	BRACKET-SWIVEL,BOTTOM;UD8000 37/40 QUAD,	1	SNA	
..3		BN61-08733A	HOLDER-SWIVEL,BOTTOM;32-40 SLIM QUAD STA	1	SNA	
...4		0103-009825	RESIN-POM;TS-25A,Dark Gray,GY0199,HB	5	SNA	
..3		BN61-08734A	HOLDER-STAND,NECK;32-40 SLIM QUAD STAND,	1	SNA	
...4		0103-007285	RESIN-PC;MW32020GFU,K032202GFV,BK0007,V2	95	SNA	
..3		BN61-08735A	BRACKET-STAND, TOP;32-40 SLIM QUAD STAND,	1	SNA	
..3		BN61-08736A	BRACKET-STAND,BOTTOM;32-40 SLIM QUAD STA	1	SNA	
..3		BN63-05135E	COVER-SHEET;4-LEG,Rhcm PE Vinyl,T0.05,W6	2	SNA	
..3		BN63-10154A	COVER-STAND, TOP-FRONT;32-40 SLIM QUAD ST	1	SNA	
..3		BN63-10155A	COVER-STAND, TOP-REAR-LEFT;32-40 SLIM QUA	1	SNA	
..3		BN63-10156A	COVER-STAND, TOP-REAR-RIGHT;32-40 SLIM QU	1	SNA	
..3		BN63-10157A	COVER-STAND,BASE;32-40 SLIM QUAD STAND,A	1	SNA	
...4		0103-005041	RESIN-PC;FR3200TV,901408,BK0008,1.2mm V-	120	SNA	
..3		BN67-00385D	RUBBER-FOOT;RUBBER-FOOT,SILICONE,ROUND,1	4	SNA	
1		BN90-04578J	ASSY W/I;UF6K	1	SNA	
0.2		BN81-08159Z	PART SET-ELEC W/I;UF4* ~ UF8* ELEC	1	SNA	
0.2		BN81-08174Q	PART SET-MECH W/I;UF6P,U40FP*	1	SNA	
1		BN90-04769F	ASSY COVER MIDDLE;UF6300 40	1	SNA	
0.2		6001-002755	SCREW-MACHINE;BH,+.,M3,L6,ZPC(BLK),SWRCH1	14	SA	
0.2	SCREW	6003-001782	SCREW-TAPTYPE;BH,+.,B,M4,L12,ZPC(BLK),SWR	2	SA	
0.2		BN96-26634U	ASSY COVER P-MIDDLE,REAR;UF6320 40,PC V2	1	SA	
..3		0203-001598	TAPE-FILAMENT;#8915,0.15,12,55000,CLR	0	SNA	
..3	SCREW	6003-000115	SCREW-TAPTYPE;BH,+.,B,M3,L6,ZPC(BLK),SWRC	2	SA	
..3	CCM1	BN63-02183D	COVER-SHEET;Rhcm,PE Vinyl,T0.05,680mm,20	1	SNA	
..3		BN63-07556X	COVER-SHEET;F-LED 3D VE,PO-SHEET,T0.068,	3	SNA	
..3		BN63-10188B	COVER-MIDDLE,REAR;F6100/6170,40,PC/PC+AB	1	SNA	
...4		0103-007268	RESIN-PC;TN-1045M,70784,TP0010,0.8, 3.0	410	SNA	
...4		0103-009587	RESIN-PC ABS;NE-1010,431322,RD0071,1.5 V	1900	SNA	
..3		BN63-10851A	SHEET-COVER;UF5000,PET,0.145,16,BLACK	2	SNA	
..3	T0071	BN64-02224J	INLAY-TERMINAL;UF6200-F6800,PS SHEET,T0.	1	SNA	
..3		BN68-03518D	LABEL-STICKER-CI SLOT;WW,ALL,PE,132.5,72	1	SNA	
..3		BN68-04709S	LABEL-TERMINAL SIDE;UF6300,PET,T0.05,UO/	1	SNA	
..3	FB01A	BN96-26401E	ASSY BOARD P-JOG SWITCH & IR;UE40F6400,F	1	SA	

Level	Location No.	Code No.	Description & Specification	Q'ty	SA/SNA	Remark
...4	EC13	BN39-01772B	LEAD CONNECTOR;UE40F6400,Cable Connector	1	SNA	
...4	5WAY	BN96-26401A	ASSY BOARD P-JOG SWITCH & IR;UE32F5000,F	1	SNA	
1		BN91-10253H	ASSY SHIELD;UA40F6400ARX*	1	SNA	
0.2		6001-003016	SCREW-MACHINE;PWH,+,M3.0,L5.0,ZPC(WHT),S	9	SA	
0.2	SCREW	6003-000115	SCREW-TAPTYPE;BH,+,B,M3,L6,ZPC(BLK),SWRC	1	SA	
0.2		BN02-00102B	TAPE FILAMENT;UE7000,#893,0.15,25,50,WHI	0	SNA	
0.2	EC13	BN39-01475A	LEAD CONNECTOR;UN32C6400,Flat Connector,	1	SA	
0.2	EC14	BN39-01744A	LEAD CONNECTOR-LED WIRE HARNESS;DIRECT w	1	SA	
0.2	P001A	BN44-00622B	DC VSS-LED TV PD BD;L42X1Q_DHS,L42X1Q_DH	1	SA	
0.2	NW01	BN59-01161A	NETWORK;WIDT-30Q,Internal WiFi,USB,IEEE8	1	SA	
0.2		BN61-08813D	HOLDER-SIDE AV;F6100/6300,ABS+PC,WINERED	1	SNA	
0.2		BN62-00367A	PAD GAP;F6400,SILICON,35 35 mm,6.5,Light	1	SNA	
0.2	FC05	BN63-10178F	COVER-JACK;UF6100/6300 40"-50" EO,ABS+PC	1	SNA	
..3		0103-009587	RESIN-PC ABS;NE-1010,431322,RD0071,1.5 V	20	SNA	
0.2		BN67-00364C	RUBBER-FOOT;X13,RUBBER,10*10,6,Dark Gray	1	SNA	
0.2	LVDS	BN96-24278N	ASSY CABLE P-FFC;UE40F6470,FFC,251mm,51P	1	SA	
0.2	BT	BN96-25376A	ASSY BOARD P-RF-MODULE;Bluetooth Module,	1	SA	
..3	AS BT	BN81-08545A	A/S-BT;Bluetooth Module SCREW	1	SNA	
..3		BN97-07275A	ASSY MICOM-BLUETOOTH F/W;BN81-08385A	1	SNA	
...4		BN81-08385A	AS-BLUETOOTH F/W;BLUETOOTH F/W	1	SNA	
0.2	SP01A	BN96-25565A	ASSY SPEAKER P;6ohm,10W,Enclosure_F6k	1	SA	
1		BN91-11064A	ASSY LCM-AMLCD;BN95-01110A,CY-HF400CSLV2	1	SNA	
0.2	PANEL	BN95-01110A	PRODUCT LCD-AMLCD;LSF400HJ01,CY-HF400CSL	1	SA	
..3		6001-002757	SCREW-MACHINE;BH,+,M3,L4,ZPC(WHT),SWRCH1	2	SA	
..3		BN02-00102B	TAPE FILAMENT;UE7000,#893,0.15,25,50,WHI	1	SNA	
..3		BN63-10731A	COVER-SOURCE,PCB(L);Y13 SF-LED 40,ABS,HB	2	SNA	
...4		0103-007797	RESIN-ABS;EA-0640,K2007,HB	48	SNA	
..3	AS109	BN63-11085A	SHEET-SIDE;F6100,TAPE,0.125,25mm,130m,BL	3	SNA	
..3		BN68-02471A	LABEL-STICKER;WW,Art Paper,80,40,AV	1	SNA	
..3		BN90-04952A	ASSY MISC-BLU;VNB 40	1	SNA	
...4		BN02-00152H	TAPE ETC-SHEET FIXING;Y13 Slim F-LED,PET	3	SNA	
...4		BN61-08638A	LGP-DIFFUSER PLATE;40" Slim FLED_Diffus	1	SNA	
...4		BN61-09304A	SUPPORT-PLATE;Y13 SLIM / VNB,PC,WHT + CL	8	SNA	
....5		0103-005036	RESIN-PC;M2407,550115,TP0003	12	SNA	
....5		0103-009493	RESIN-PC;LH-1070W,W92853,WT0107,V-2	20	SNA	
...4		BN63-10447A	SHEET-REFLECTOR;SY95,SHEET*,0.188,886.6,	1	SNA	
...4		BN63-10453A	SHEET-DIFFUSER;40inch, SFLED, UTA10 / DM	1	SNA	
...4		BN96-25294F	ASSY MISC P-CHASSIS BOTTOM;Y13 SF-LED 40	1	SNA	
....5		6001-002759	SCREW-MACHINE;CH,+,M3,L4,ZPC(BLK),SWRCH1	1	SA	
....5		6001-003005	SCREW-MACHINE;BH,+,M3,L6,ZPC(WHT),SWRCH1	4	SNA	
....5		BN02-00040C	TAPE DOUBLE FACE-D-PLATE;F-LED ALL,MKT50	2	SNA	
....5		BN02-00043D	TAPE ETC-SHEET FIXING;Y13 slim F-LED,PET	2	SNA	
....5		BN02-00134E	TAPE ETC-SHEET FIXING;SFLED 32/40/46/55/	6	SNA	
....5		BN60-00792A	SPACER-SOURCE PCB GASKET;Y13 Slim F-LED,	4	SNA	
....5		BN61-08161A	HOLDER-LED-PCB;Direct-LED,PC,white	2	SNA	
....6		0103-009493	RESIN-PC;LH-1070W,W92853,WT0107,V-2	2	SNA	
....5		BN61-09049A	BRACKET-WALL MOUNT;Y13 ALL Model,SPCC,T1	4	SNA	

ANNEX. Exploded View & Part List

Level	Location No.	Code No.	Description & Specification	Q'ty	SA/SNA	Remark
....5		BN61-09101A	SUPPORT-SOURCE PCB;SF-LED,ABS+PC,V0,GRAY	4	SNA	
....6		0103-009930	RESIN-PC ABS;NH-1017SG,GRAY,GY0275,V0	8	SNA	
....5		BN61-09555A	HOLDER-SOURCE PCB;Y13 SF-LED 40 (VNB CEL	4	SNA	
....6		0103-007442	RESIN-PC ABS;NH-1017SG,W91902,WT0034,2.0	8	SNA	
....5		BN62-00338M	INSULATION-PD BOARD;Y13 SF-LED 39"~55",P	1	SNA	
....5	CC02	BN64-02199E	CHASSIS-BOTTOM;Y13 F-LED Slim 40" VNB CE	1	SNA	
....5		BN96-25336A	ASSY BOARD P-D-LED INTERFACE;40inch Slim	1	SNA	
...4		BN96-25304A	ASSY MISC P-LED BAR;40inch Slim Direct L	7	SA	
...4		BN96-25305A	ASSY MISC P-LED BAR;40inch Slim Direct L	7	SA	
...4		BN96-28375A	ASSY FRAME P-MOLD MIDDLE;Y13 6K SF-LED 4	1	SNA	
....5		BN60-00700E	SPACER-PANEL (UD);13 SF-LED 40,SILICON+T	1	SNA	
....5		BN60-00700W	SPACER-PANEL (LR);13 SF-LED 40" VNB,SILI	2	SNA	
....5		BN60-00700X	SPACER-PANEL (U);13 SF-LED 40" VNB,SILIC	1	SNA	
....5		BN60-00744B	SPACER-RUBBER;Y13 F-LED SLIM(VNB CELL),S	2	SNA	
....5		BN61-09554A	FRAME-MOLD MIDDLE;Y13 SF-LED 40 (VNB CEL	1	SNA	
....6		0103-009559	RESIN-PC;210GNH15,6919A,BK0007,PC ABS GF	150	SNA	
..3	TCON	BN95-00858A	ASSY T CON;LSF400HF02,40 FHD 120 VNB	1	SC	
...4		BN02-00102B	TAPE FILAMENT;UE7000,#893,0.15,25,50,WHI	0	SNA	
...4		BN62-00371A	HEAT SINK-PS;F6000,A1050,ANODIZING,110*6	1	SNA	
...4		BN62-00372B	HEAT SINK-PS;F5000/6000,A5052*,BLACK,32*	1	SNA	
...4		BN97-06996A	ASSY SMD;BN95-00858A	1	SNA	
....5		0202-001830	SOLDER-CREAM;LFM-48W TM-HP,D20~38um,96.5	2	SNA	
....5		0404-001640	DIODE-SCHOTTKY;SS1060HEWS,60V,1000mA,SOD	2	SA	
....5		0404-001643	DIODE-SCHOTTKY;B360A,60V,3000mA,SMA,TP	1	SA	
....5		0406-001317	DIODE-TVS;SMAJ14A,15.6/-/17.2V,400W,SMA	1	SNA	
....5		0406-001324	DIODE-TVS;RClamp1502B,16.7/-/17.2V,200W,SOT	2	SNA	
....5		0406-001438	DIODE-TVS;SMCJ14A,15.6/-/17.2V,1500W,DO-	1	SA	
....5		0406-001445	DIODE-TVS;RClamp7512N,2.7/2.8/2.9,300W,S	2	SA	
....5		0406-001483	DIODE-TVS;ESD5B5.0ST1G,5,8V/- /7.8V,50W,	2	SA	
....5		0406-001556	DIODE-TVS;NUP4114UCW1,6/-/17.2V,180W,SC-88	3	SA	
....5		0406-001578	DIODE-TVS;P4SMAJ40A,44.4,51.1,400W,SMA	1	SA	
....5		0502-001331	TR-POWER;NSS30100LT1G,PNP,310mW,SOT-23,T	3	SA	
....5		0502-001345	TR-POWER;FCX491A,NPN,1000mW,SOT89,TR,900	3	SA	
....5		0502-001346	TR-POWER;FCX591A,PNP,1000mW,SOT89,TR,30/	2	SA	
....5		0505-002826	FET-SILICON;ZXMN6A07F,N,60V,1A,0.4ohm,0.	1	SNA	
....5		0505-003224	FET-SILICON;AO6405,P,-30V,-5A,0.052ohm,2	1	SA	
....5	EL02	0601-002037	LED;SMD(TOP VIEW),BLUE,1.6x0.8mm,465/470	3	SNA	
....5		0801-003292	IC-CMOS LOGIC;7WB66,Bus Switch,MAB08A,8P	1	SA	
....5		1105-002227	IC-DDR3 SDRAM;K4B1G1646G-BCK0,DDR3 SDRAM	1	SA	
....5		1201-003130	IC-OP AMP;iML2811SEC,TDFN-EP,TP,8P,3x3mm	1	SA	
....5		1203-006130	IC-POSI.FIXED REG.;S-1172B25-U5T1G,SOT-8	1	SA	
....5		1203-006138	IC-POSI.ADJUST REG.;AP1117DGZ-13-89,TO-2	1	SA	
....5		1203-006999	IC-DC/DC CONVERTER;SM4152,QFN,48P,7x7mm,	1	SNA	
....5		1203-007447	IC-VOL. GENERATOR;RT6503GQW,QFN,48Z30,7x	1	SNA	
....5		1203-007552	IC-DC/DC CONVERTER;TPS56921PWPR,HTSSOP,2	1	SA	
....5		1204-003406	IC-VIDEO PROCESS;SDP1203,HSFCBGA,756Z30,	1	SA	
....5	IS01	1209-002183	IC-SENSOR;S-5851AAA-M6T1U,SOT,6Z30,2.9x1	1	SA	

Level	Location No.	Code No.	Description & Specification	Q'ty	SA/SNA	Remark
....5		1404-001731	THERMISTOR-NTC;33Kohm,4050K,1mW/C,TP,1.6	1	SNA	
....5		2007-000034	R-CHIP;1ohm,5%,1/4W,TP,3216	1	SNA	
....5		2007-000040	R-CHIP;150ohm,1%,1/10W,TP,1608	2	SNA	
....5		2007-000043	R-CHIP;1Kohm,1%,1/10W,TP,1608	4	SA	
....5		2007-000052	R-CHIP;10Kohm,1%,1/10W,TP,1608	3	SA	
....5		2007-000060	R-CHIP;100Kohm,1%,1/10W,TP,1608	1	SNA	
....5		2007-000063	R-CHIP;150Kohm,1%,1/10W,TP,1608	1	SNA	
....5		2007-000066	R-CHIP;20Kohm,1%,1/10W,TP,1608	1	SNA	
....5		2007-000067	R-CHIP;15Kohm,1%,1/10W,TP,1608	1	SNA	
....5		2007-000070	R-CHIP;0ohm,5%,1/10W,TP,1608	14	SA	
....5		2007-000109	R-CHIP;1Mohm,5%,1/10W,TP,1608	1	SA	
....5		2007-000138	R-CHIP;100ohm,5%,1/16W,TP,1005	9	SA	
....5		2007-000140	R-CHIP;1Kohm,5%,1/16W,TP,1005	2	SNA	
....5		2007-000143	R-CHIP;4.7Kohm,5%,1/16W,TP,1005	11	SNA	
....5		2007-000148	R-CHIP;10Kohm,5%,1/16W,TP,1005	8	SA	
....5		2007-000171	R-CHIP;0ohm,5%,1/16W,TP,1005	9	SNA	
....5		2007-000256	R-CHIP;1.6Kohm,1%,1/10W,TP,1608	1	SA	
....5		2007-000336	R-CHIP;120Kohm,1%,1/10W,TP,1608	4	SA	
....5		2007-000455	R-CHIP;18Kohm,1%,1/10W,TP,1608	2	SA	
....5		2007-000516	R-CHIP;2.7Kohm,1%,1/10W,TP,1608	3	SA	
....5		2007-000726	R-CHIP;300ohm,1%,1/10W,TP,1608	2	SA	
....5		2007-000736	R-CHIP;30Kohm,1%,1/10W,TP,1608	2	SA	
....5		2007-000772	R-CHIP;33Kohm,1%,1/10W,TP,1608	1	SA	
....5		2007-000779	R-CHIP;33ohm,1%,1/10W,TP,1608	1	SA	
....5		2007-000869	R-CHIP;4.7Kohm,1%,1/10W,TP,1608	1	SA	
....5		2007-000962	R-CHIP;5.1Kohm,1%,1/10W,TP,1608	4	SA	
....5		2007-000979	R-CHIP;5.6Kohm,1%,1/10W,TP,1608	1	SA	
....5		2007-001038	R-CHIP;56Kohm,1%,1/10W,TP,1608	1	SA	
....5		2007-001125	R-CHIP;68Kohm,1%,1/10W,TP,1608	1	SA	
....5		2007-001139	R-CHIP;7.5Kohm,1%,1/10W,TP,1608	1	SA	
....5		2007-001153	R-CHIP;750ohm,1%,1/10W,TP,1608	1	SA	
....5		2007-001175	R-CHIP;8.2Kohm,1%,1/10W,TP,1608	1	SA	
....5		2007-001206	R-CHIP;82Kohm,1%,1/10W,TP,1608	1	SNA	
....5		2007-001433	R-CHIP;12Kohm,1%,1/10W,TP,1608	2	SA	
....5		2007-002437	R-CHIP;2ohm,5%,1/10W,TP,1608	3	SNA	
....5		2007-002899	R-CHIP;10ohm,1%,1/10W,TP,1608	18	SA	
....5		2007-002900	R-CHIP;11Kohm,1%,1/10W,TP,1608	1	SNA	
....5		2007-007107	R-CHIP;100Kohm,1%,1/16W,TP,1005	1	SNA	
....5		2007-007136	R-CHIP;4.7Kohm,1%,1/16W,TP,1005	10	SNA	
....5		2007-007156	R-CHIP;1ohm,5%,1/16W,TP,1005	2	SNA	
....5		2007-007306	R-CHIP;100ohm,1%,1/16W,TP,1005	18	SNA	
....5		2007-007309	R-CHIP;12Kohm,1%,1/16W,TP,1005,0.35	2	SA	
....5		2007-007312	R-CHIP;20Kohm,1%,1/16W,TP,1005	1	SA	
....5		2007-007316	R-CHIP;3.3Kohm,1%,1/16W,TP,1005	2	SA	
....5		2007-007318	R-CHIP;1Kohm,1%,1/16W,TP,1005	11	SNA	
....5		2007-007517	R-CHIP;240ohm,1%,1/16W,TP,1005	3	SNA	
....5		2007-007651	R-CHIP;9.1Kohm,1%,1/10W,TP,1608	3	SA	

ANNEX. Exploded View & Part List

Level	Location No.	Code No.	Description & Specification	Q'ty	SA/SNA	Remark
....5		2007-007698	R-CHIP;5.1Kohm,1%,1/16W,TP,1005	1	SNA	
....5		2007-007766	R-CHIP;2Kohm,1%,1/16W,TP,1005	5	SNA	
....5		2007-007798	R-CHIP;10ohm,1%,1/16W,TP,1005	32	SA	
....5		2007-008015	R-CHIP;75ohm,1%,1/16W,TP,1005	18	SA	
....5		2007-008117	R-CHIP;2.7Kohm,1%,1/16W,TP,1005	1	SA	
....5	AD480	2203-000257	C-CER,CHIP;10nF,10%,50V,X7R,TP,1608	4	SA	
....5	AD480	2203-000489	C-CER,CHIP;2.2nF,10%,50V,X7R,TP,1005	2	SA	
....5	AD480	2203-000995	C-CER,CHIP;0.047nF,5%,50V,C0G,TP,1005	2	SA	
....5	AD480	2203-001126	C-CER,CHIP;0.68nF,10%,50V,X7R,TP,1608	1	SNA	
....5	AD480	2203-001697	C-CER,CHIP;0.082nF,5%,50V,NP0,TP,1608	2	SNA	
....5	AD480	2203-001851	C-CER,CHIP;0.016nF,5%,50V,NP0,TP,1608	2	SNA	
....5	AD480	2203-002711	C-CER,CHIP;100nF,10%,25V,X7R,TP,1608	3	SA	
....5	AD480	2203-002982	C-CER,CHIP;6.8nF,10%,50V,X7R,TP,1005	1	SA	
....5	AD480	2203-005138	C-CER,CHIP;1.8nF,10%,50V,X7R,TP,1005	3	SA	
....5	AD480	2203-005249	C-CER,CHIP;100nF,10%,50V,X7R,TP,1608	8	SNA	
....5	AD480	2203-005344	C-CER,CHIP;22nF,10%,25V,X7R,TP,1005,0.5T	3	SNA	
....5	AD480	2203-005918	C-CER,CHIP;1000nF,10%,6.3V,X7R,TP,1608	2	SNA	
....5	AD480	2203-006048	C-CER,CHIP;100nF,10%,10V,X7R,TP,1005	9	SA	
....5	AD480	2203-006158	C-CER,CHIP;100nF,10%,16V,X7R,TP,1005,0.5	61	SNA	
....5	AD480	2203-006320	C-CER,CHIP;2200nF,10%,16V,X7R,TP,2012	1	SNA	
....5	AD480	2203-006348	C-CER,CHIP;1000nF,10%,25V,X5R,TP,1608,0.	2	SA	
....5	AD480	2203-006427	C-CER,CHIP;4700nF,10%,16V,X5R,TP,2012	1	SA	
....5	AD480	2203-006474	C-CER,CHIP;22000nF,20%,6.3V,X5R,TP,2012	6	SA	
....5	AD480	2203-006562	C-CER,CHIP;1000nF,10%,10V,X5R,TP,1005	2	SNA	
....5	AD480	2203-006698	C-CER,CHIP;1000nF,10%,25V,X7R,TP,1608,0.	9	SA	
....5	AD480	2203-006890	C-CER,CHIP;10000nF,20%,6.3V,X5R,TP,1608	8	SA	
....5	AD480	2203-006960	C-CER,CHIP;1000nF,10%,50V,X7R,TP,2012	2	SNA	
....5	AD480	2203-007240	C-CER,CHIP;22000nF,20%,6.3V,X5R,TP,1608,	3	SA	
....5	AD480	2203-007270	C-CER,CHIP;10000nF,10%,10V,X5R,TP,1608,0	13	SNA	
....5	AD480	2203-007306	C-CER,CHIP;10000nF,10%,25V,X5R,TP,2012,1	31	SNA	
....5		2409-001118	C-POLYMER ,CHIP;47uF,20%,10V,WT,TP,3.5X2	1	SA	
....5		2409-001240	C-ORGANIC,SMD;33uF,20%,25V,LR,TP,7343(1.	1	SA	
....5		2703-003747	INDUCTOR-SMD;22uH,20%,6060,0.135ohm,1300	2	SA	
....5		2703-003803	INDUCTOR-SMD;4.7uH,20%,6060,0.031ohm,270	1	SA	
....5		2703-003862	INDUCTOR-SMD;10uH,20%,6060,0.065ohm,1900	1	SA	
....5		2703-003867	INDUCTOR-SMD;22uH,20%,4040,1.8T,0.29Ohm,	1	SA	
....5		2703-003937	INDUCTOR-SMD;1uH,20%,7.0x6.47x3.0mm,0.00	1	SA	
....5		2703-004199	INDUCTOR-SMD;10uH,20%,7066,2.2mm,0.101Oh	1	SNA	
....5		2801-003954	CRYSTAL-SMD;27MHz,30ppm,28-AAN,16pF,50oh	1	SA	
....5		3301-002039	BEAD-SMD;26ohm,1608,TP	24	SA	
....5		3601-001386	FUSE-SURFACE MOUNT;125V,5A,FAST-ACTING,C	1	SA	
....5		3708-002157	CONNECTOR-FPC/FFC/PIC;80P,0.5mm,SMD-A,AU	2	SNA	
....5	EH01	3711-005601	HEADER-BOARD TO CABLE;BOX,8P,1R,2mm,SMD-	1	SA	
....5	EH01	3711-005925	HEADER-BOARD TO CABLE;BOX,51P,1R,0.5mm,S	1	SA	
....5		6302-001290	GASKET;SMR-TS-4-4.5-3,4.0mm,Ni+Au+SUS+Mg	4	SNA	
....5		BN41-01939B	PCB MAIN;2013 FHD 120Hz/240Hz,FR-4,4,1.2	1	SNA	
....5		BN97-07132A	ASSY MICOM;F40A1F0611_011d,2013.02.16	1	SNA	

Level	Location No.	Code No.	Description & Specification	Q'ty	SA/SNA	Remark
....6		1107-002224	IC-FLASH MEMORY;W25X40CLSSIG,4Mbit,SOP,8	1	SNA	
..3	OC-TC	BN96-24429D	ASSY CABLE P-FFC;E7000,FFC,60mm□1,80P	2	SNA	
..3		BN96-24842A	ASSY OPEN CELL;LSF400HF02-A,8bit,40 INCH	1	SNA	
...4		BN81-07435A	A/S-ADHESIVE-A.C.F;ADHESIVE-A.C.F,2-ADHE	1	SNA	
...4		BN81-07880B	A/S-IC DRIVER SOURCE;IC DRIVER SOURCE,13	1	SNA	
...4		BN81-07891A	A/S-POLARIZER-C/F;8-POLARIZER-C/F	1	SNA	
...4		BN81-07903A	A/S-POLARIZER-TFT;POLARIZER-TFT	1	SNA	
...4		BN81-07921B	A/S-ASSY PCB-SOURCE LEFT;ASSY PCB-SOURCE	1	SNA	
...4		BN81-07922B	A/S-ASSY PCB-SOURCE RIGHT;ASSY PCB-SOURC	1	SNA	
...4		BN81-07943A	A/S-ADHESIVE-A.C.F(TP500B);ADHESIVE-A.C.	1	SNA	
..3	TC01A	BN96-28376A	ASSY MISC P-CHASSIS TOP;Y13 SF-LED 40(6K	1	SNA	
...4		BN60-00667B	SPACER-GASKET;Y13 SF-LED,GASKET(FG200A),	4	SNA	
...4		BN60-00701C	SPACER-TOP,UD;Y13 Slim F-LED 40,GASKET,L	2	SNA	
...4		BN60-00701D	SPACER-TOP,LR;Y13 Slim F-LED 40,GASKET*,	2	SNA	
...4		BN60-00715B	SPACER-TOP CORNER;Y13 Slim F-LED,GASKET+	4	SNA	
...4		BN60-00743C	SPACER-PET (UD);Slim F-LED 40",SB00 + SK	2	SNA	
...4		BN63-07556U	COVER-SHEET;F-LED,urethane,T0.068,W18,10	1	SNA	
...4		BN63-10945B	COVER-SHEET;Y13 SF-LED,PO-SHEET,T0.068,W	2	SNA	
...4		BN63-11161A	SHEET-THERMAL;GAP PAD,1.5,W 7,L 65,BLACK	8	SNA	
...4	AC157	BN64-02405A	CHASSIS-TOP;Y13 SF-LED40 F6K(VNB CELL),P	1	SNA	
....5		0103-009559	RESIN-PC;210GNH15,6919A,BK0007,PC ABS GF	260	SNA	
1	M0017	BN91-11310R	ASSY CHASSIS;UE40F6320AWXXC	1	SNA	
0.2	M0014	BN94-06624R	ASSY PCB MAIN;UE40F6320AWXXC	1	SA	
..3		0202-001608	SOLDER-WIRE FLUX;LFC7-107,D0.8,99.3Sn/0.	0	SNA	
..3		BN62-00365B	HEAT SINK-PS;F 4k,5k,6k,A1050,ANODIZING,	1	SNA	
..3		BN97-07019Y	ASSY SMD;F6400,EUROPE,PAL,DVB-T/C	1	SNA	
...4		0202-001830	SOLDER-CREAM;LFM-48W TM-HP,D20-38um,96.5	6	SNA	
...4	DS01A	0401-001056	DIODE-SWITCHING;MMBD4148SE,100V,200mA,SO	2	SA	
...4		0403-001783	DIODE-ZENER;BZB84-C6V2,5.8/6.6V,300mW,SO	4	SNA	
...4		0404-001404	DIODE-SCHOTTKY;BAT721C,40V,200mA,SOT-23,	3	SA	
...4		0406-001200	DIODE-TVS;RCLAMP0504F,6/-V,150W,SC-70	4	SA	
...4		0406-001271	DIODE-TVS;RCLAMP0524P,6/-V,150W,SLP251	1	SNA	
...4		0501-000279	TR-SMALL SIGNAL;KSA1182-Y,PNP,150mW,SOT-	2	SA	
...4		0501-000445	TR-SMALL SIGNAL;KTC3875S-Y,NPN,150mW,SOT	10	SC	
...4		0505-000110	FET-SILICON;2N7002,N,60V,115mA,7.5ohm,0.	10	SA	
...4		0505-002560	FET-SILICON;AO6415,P,-20V,-3.3A,0.15ohm,	1	SA	
...4		0505-002598	FET-SILICON;AP2317GN,P,-20V,-4.2A,0.052o	1	SA	
...4		0801-002701	IC-CMOS LOGIC;74VHCT125A,BUFFER,TSSOP,14	1	SA	
...4		0801-002780	IC-CMOS LOGIC;74LVC1G17,SCHMITT-TRIGGER	1	SA	
...4		0801-003330	IC-CMOS LOGIC;Octal buffer,DQFN,20P,4.5x	2	SA	
...4		0904-002803	IC-USC;AU6258S-JKF,QFN,28Z30,5.0mm X 5.0	1	SNA	
...4		1001-001545	IC-ANALOG MULTIPLEX;TS3USB221ERSER,R-PQF	1	SA	
...4		1103-001487	IC-EEPROM;AT24C256C-SSHL-T,256Kbit,32Kx8	1	SA	
...4		1105-002338	IC-DDR3 SDRAM;K4B4G1646B-HCMA,DDR3 1866,	1	SA	
...4		1105-002430	IC-DDR3 SDRAM;K4B2G1646E-BCMA,DDR3 1866,	2	SA	
...4		1201-003183	IC-AUDIO AMP;DRV612,HTSSOP,14P,5x4.4mm,D	1	SA	
...4		1201-003526	IC-AUDIO AMP;TAS5745,QFP,48Z30,7x7mm,DUA	1	SNA	

ANNEX. Exploded View & Part List

Level	Location No.	Code No.	Description & Specification	Q'ty	SA/SNA	Remark
...4		1203-004364	IC-VOL. DETECTOR;RT9818C-42PV,SOT-23,3P,	1	SA	
...4		1203-006109	IC-POSI.FIXED REG.;S-1206B33-M3T1G,SOT-2	2	SA	
...4		1203-006130	IC-POSI.FIXED REG.;S-1172B25-U5T1G,SOT-8	1	SA	
...4		1203-006135	IC-POSI.FIXED REG.;AP1117D-33-GZ-13-89,T	1	SA	
...4		1203-006136	IC-POSI.FIXED REG.;AP1117D-18-GZ-13-89,T	1	SA	
...4		1203-006138	IC-POSI.ADJUST REG.;AP1117DGZ-13-89,TO-2	1	SA	
...4		1203-007238	IC-PWM CONTROLLER;TPS54427,DDA,8P,4.8x3.	1	SNA	
...4		1203-007242	IC-POSI.ADJUST REG.;G2992BP11U,SOP-8,8P,	1	SA	
...4		1203-007502	IC-DC/DC CONVERTER;AOZ3011PI,SO-8,8Z30,4	1	SA	
...4		1203-007695	IC-DC/DC CONVERTER;AOZ3018,SO-8,8Z30,4.9	1	SNA	
...4		1203-007728	IC-VOL. DETECTOR;RT9831GQW,QW : WQFN-20L	1	SA	
...4		1204-003421	IC-DECODER;SEMS30,PBGA,729Z30,21.6x21.6m	1	SA	
...4		1205-004447	IC-SWITCH;TPS2051CDBVR,SOT23-5,5P,3x1.65	4	SA	
...4		1205-004691	IC-SWITCH;BD82022FVJ,MSOP-8L JEDEC,8Z30,	1	SNA	
...4		1405-001271	VARISTOR;35V,20Vdc,5A,1.0x0.5x0.6mm,TP,1	28	SA	
...4		2007-000137	R-CHIP;2Kohm,5%,1/16W,TP,1005	13	SNA	
...4		2007-000138	R-CHIP;100ohm,5%,1/16W,TP,1005	12	SA	
...4		2007-000142	R-CHIP;2.7Kohm,5%,1/16W,TP,1005	1	SA	
...4		2007-000143	R-CHIP;4.7Kohm,5%,1/16W,TP,1005	50	SNA	
...4		2007-000148	R-CHIP;10Kohm,5%,1/16W,TP,1005	43	SA	
...4		2007-000153	R-CHIP;22Kohm,5%,1/16W,TP,1005	6	SNA	
...4		2007-000155	R-CHIP;27Kohm,5%,1/16W,TP,1005	1	SNA	
...4		2007-000157	R-CHIP;47Kohm,5%,1/16W,TP,1005	16	SNA	
...4		2007-000170	R-CHIP;1Mohm,5%,1/16W,TP,1005	3	SNA	
...4		2007-000171	R-CHIP;0ohm,5%,1/16W,TP,1005	12	SNA	
...4		2007-000172	R-CHIP;10ohm,5%,1/16W,TP,1005	5	SNA	
...4		2007-000173	R-CHIP;22ohm,5%,1/16W,TP,1005	12	SNA	
...4		2007-000174	R-CHIP;47ohm,5%,1/16W,TP,1005	2	SNA	
...4		2007-000256	R-CHIP;1.6Kohm,1%,1/10W,TP,1608	1	SA	
...4		2007-000336	R-CHIP;120Kohm,1%,1/10W,TP,1608	1	SA	
...4		2007-000583	R-CHIP;22Kohm,1%,1/10W,TP,1608	2	SA	
...4		2007-000695	R-CHIP;3.3ohm,5%,1/10W,TP,1608	2	SNA	
...4		2007-000775	R-CHIP;33Kohm,5%,1/16W,TP,1005	1	SNA	
...4		2007-000803	R-CHIP;36Kohm,1%,1/10W,TP,1608	2	SA	
...4		2007-000857	R-CHIP;4.3Kohm,1%,1/10W,TP,1608	5	SNA	
...4		2007-000932	R-CHIP;470ohm,5%,1/16W,TP,1005	3	SNA	
...4		2007-000979	R-CHIP;5.6Kohm,1%,1/10W,TP,1608	1	SA	
...4		2007-001116	R-CHIP;680ohm,1%,1/10W,TP,1608	1	SA	
...4		2007-001125	R-CHIP;68Kohm,1%,1/10W,TP,1608	1	SA	
...4		2007-001168	R-CHIP;75ohm,5%,1/4W,TP,3216	1	SA	
...4		2007-001288	R-CHIP;18ohm,5%,1/16W,TP,1005	4	SA	
...4		2007-001292	R-CHIP;33ohm,5%,1/16W,TP,1005	14	SNA	
...4		2007-001298	R-CHIP;51ohm,5%,1/16W,TP,1005	2	SNA	
...4		2007-001301	R-CHIP;68ohm,5%,1/16W,TP,1005	7	SA	
...4		2007-002970	R-CHIP;56ohm,5%,1/16W,TP,1005	4	SA	
...4		2007-003015	R-CHIP;2.2ohm,5%,1/16W,TP,1005	1	SA	
...4		2007-003022	R-CHIP;62ohm,5%,1/16W,TP,1005	26	SNA	

Level	Location No.	Code No.	Description & Specification	Q'ty	SA/SNA	Remark
...4		2007-007001	R-CHIP;3.9Kohm,5%,1/16W,TP,1005	1	SA	
...4		2007-007095	R-CHIP;390ohm,5%,1/16W,TP,1005	1	SA	
...4		2007-007107	R-CHIP;100Kohm,1%,1/16W,TP,1005	8	SNA	
...4		2007-007135	R-CHIP;18Kohm,1%,1/16W,TP,1005	4	SNA	
...4		2007-007138	R-CHIP;27Kohm,1%,1/16W,TP,1005	1	SA	
...4		2007-007142	R-CHIP;10Kohm,1%,1/16W,TP,1005	2	SNA	
...4		2007-007156	R-CHIP;1ohm,5%,1/16W,TP,1005	13	SNA	
...4		2007-007238	R-CHIP;8.25Kohm,1%,1/10W,TP,1608	1	SA	
...4		2007-007316	R-CHIP;3.3Kohm,1%,1/16W,TP,1005	3	SA	
...4		2007-007318	R-CHIP;1Kohm,1%,1/16W,TP,1005	33	SNA	
...4		2007-007331	R-CHIP;90.9Kohm,1%,1/10W,TP,1608	1	SA	
...4		2007-007463	R-CHIP;1.1Kohm,1%,1/16W,TP,1005	1	SA	
...4		2007-007470	R-CHIP;7.5Kohm,1%,1/16W,TP,1005	1	SNA	
...4		2007-007517	R-CHIP;240ohm,1%,1/16W,TP,1005	4	SNA	
...4		2007-007538	R-CHIP;56Kohm,1%,1/16W,TP,1005	1	SA	
...4		2007-007766	R-CHIP;2Kohm,1%,1/16W,TP,1005	3	SNA	
...4		2007-007942	R-CHIP;1Mohm,1%,1/16W,TP,1005	1	SNA	
...4		2007-007981	R-CHIP;180Kohm,1%,1/16W,TP,1005	1	SNA	
...4		2007-008015	R-CHIP;75ohm,1%,1/16W,TP,1005	11	SA	
...4		2007-008133	R-CHIP;56.2Kohm,1%,1/10W,TP,1608	1	SA	
...4		2007-008137	R-CHIP;24Kohm,1%,1/16W,TP,1005	2	SNA	
...4		2007-008275	R-CHIP;30Kohm,1%,1/16W,TP,1005	1	SNA	
...4		2007-008298	R-CHIP;49.9ohm,1%,1/16W,TP,1005	4	SA	
...4		2007-008426	R-CHIP;12.4Kohm,1%,1/10W,TP,1608	1	SA	
...4		2007-008649	R-CHIP;220ohm,1%,1/16W,TP,1005	1	SNA	
...4		2007-008807	R-CHIP;53.6Kohm,1%,1/16W,TP,1005	1	SA	
...4		2011-001261	R-NETWORK;33ohm,5%,1/16W,L,CHIP,8P,TP,2.	2	SA	
...4		2011-001262	R-NETWORK;22ohm,5%,1/16W,L,CHIP,8P,TP,2.	1	SA	
...4		2011-001344	R-NETWORK;100ohm,5%,1/16W,L,CHIP,8P,TP,2	4	SA	
...4		2011-001449	R-NETWORK;22ohm,5%,1/16W,L,4P,TP,1010	5	SA	
...4		2011-001506	R-NETWORK;10Kohm,5%,1/16W,L,CHIP,4P,TP,1	6	SNA	
...4		2011-001527	R-NETWORK;4.7Kohm,5%,1/16W,L,CHIP,4P,TP,	5	SNA	
...4		2011-001587	R-NETWORK;100ohm,5%,1/16W,L,CHIP-V,4P,TP	5	SNA	
...4	AD480	2203-000233	C-CER,CHIP;0.1nF,5%,50V,C0G,TP,1005	6	SA	
...4	AD480	2203-000386	C-CER,CHIP;0.015nF,5%,50V,C0G,TP,1005	3	SA	
...4	AD480	2203-000425	C-CER,CHIP;0.018nF,5%,50V,C0G,TP,1005	3	SA	
...4	AD480	2203-000438	C-CER,CHIP;1nF,10%,50V,X7R,TP,1005	12	SA	
...4	AD480	2203-000489	C-CER,CHIP;2.2nF,10%,50V,X7R,TP,1005	7	SA	
...4	AD480	2203-000530	C-CER,CHIP;2.7nF,10%,50V,X7R,TP,1005,-	1	SNA	
...4	AD480	2203-000575	C-CER,CHIP;220nF,10%,25V,X7R,TP,2012	6	SNA	
...4	AD480	2203-000679	C-CER,CHIP;0.027nF,5%,50V,C0G,TP,1005	2	SNA	
...4	AD480	2203-000812	C-CER,CHIP;0.033nF,5%,50V,C0G,TP,1005	7	SA	
...4	AD480	2203-000995	C-CER,CHIP;0.047nF,5%,50V,C0G,TP,1005	3	SA	
...4	AD480	2203-002285	C-CER,CHIP;10nF,10%,50V,X7R,TP,1005	21	SNA	
...4	AD480	2203-002525	C-CER,CHIP;0.56nF,10%,50V,X7R,TP,1005	4	SNA	
...4	AD480	2203-002711	C-CER,CHIP;100nF,10%,25V,X7R,TP,1608	3	SA	
...4	AD480	2203-003039	C-CER,CHIP;0.008nF,0.25pF,50V,C0G,TP,100	2	SNA	

ANNEX. Exploded View & Part List

Level	Location No.	Code No.	Description & Specification	Q'ty	SA/SNA	Remark
...4	AD480	2203-005249	C-CER,CHIP;100nF,10%,50V,X7R,TP,1608	5	SNA	
...4	AD480	2203-005344	C-CER,CHIP;22nF,10%,25V,X7R,TP,1005,0.5T	3	SNA	
...4	AD480	2203-005642	C-CER,CHIP;0.22nF,5%,50V,NP0,TP,1005	2	SNA	
...4	AD480	2203-005968	C-CER,CHIP;4.7nF,10%,50V,X7R,TP,1005,0.5	2	SNA	
...4	AD480	2203-006048	C-CER,CHIP;100nF,10%,10V,X7R,TP,1005	122	SA	
...4	AD480	2203-006126	C-CER,CHIP;47nF,10%,16V,X7R,TP,1005	17	SNA	
...4	AD480	2203-006324	C-CER,CHIP;2200nF,10%,10V,X5R,TP,1608	6	SA	
...4	AD480	2203-006348	C-CER,CHIP;1000nF,10%,25V,X5R,TP,1608,0.	4	SA	
...4	AD480	2203-006361	C-CER,CHIP;10000nF,10%,10V,X5R,TP,2012	21	SC	
...4	AD480	2203-006474	C-CER,CHIP;22000nF,20%,6.3V,X5R,TP,2012	26	SA	
...4	AD480	2203-006562	C-CER,CHIP;1000nF,10%,10V,X5R,TP,1005	19	SNA	
...4	AD480	2203-006824	C-CER,CHIP;4700nF,10%,10V,X5R,TP,1608,-	9	SNA	
...4	AD480	2203-006890	C-CER,CHIP;10000nF,20%,6.3V,X5R,TP,1608	20	SA	
...4	AD480	2203-006992	C-CER,CHIP;0.33nF,5%,50V,C0G,TP,1005	2	SNA	
...4	AD480	2203-007176	C-CER,CHIP;10000nF,10%,16V,X5R,TP,2012,1	8	SNA	
...4	AD480	2203-007513	C-CER,CHIP;10000nF,10%,10V,X5R,TP,1608,0	4	SA	
...4		2703-000158	INDUCTOR-SMD;1uH,10%,2012,40ohm,50mA,45,	4	SA	
...4		2703-001229	INDUCTOR-SMD;2.2uH,10%,1608,1.150ohm,15mA	1	SC	
...4		2703-001938	INDUCTOR-SMD;56nH,5%,1005,1.50ohm,200mA,1	3	SA	
...4		2703-003713	INDUCTOR-SMD;1.5uH,20%,7366,0.015ohm,700	2	SA	
...4		2703-003790	INDUCTOR-SMD;4.7uH,20%,8080,0.025ohm,450	1	SA	
...4		2703-003930	INDUCTOR-SMD;4.7uH,20%,5050,0.0720ohm,245	4	SA	
...4		2801-000102	CRYSTAL-SMD;12MHz,30ppm,12pF,100ohm,TP	1	SA	
...4		2801-003326	CRYSTAL-SMD;24MHz,30ppm,28-ABX,20pF,50oh	1	SA	
...4		2801-003856	CRYSTAL-SMD;0.032768MHz,20ppm,28-ACP,7pF	1	SA	
...4		2801-004775	CRYSTAL-SMD;12MHz,30ppm,16pF,30ohm,TP	1	SNA	
...4		3301-000314	BEAD-SMD;120ohm,1608,TP,120ohm/100MHz	8	SNA	
...4		3301-002039	BEAD-SMD;26ohm,1608,TP	29	SA	
...4		3601-001374	FUSE-SURFACE MOUNT;32V,5A,FAST-ACTING,PL	1	SA	
...4		3701-001856	CONNECTOR-HDMI;19P,2ROW,FEMALE,SMD-S,AU	1	SA	
...4		3701-001861	CONNECTOR-HDMI;19P,2ROW,FEMALE,SMD-A,AU	3	SA	
...4		3707-001106	CONNECTOR-OPTICAL;STRAIGHT W/L,SPDIF	1	SA	
...4		3708-003073	CONNECTOR-FPC/FFC/PIC;51P,0.5mm,SMD,AU,N	1	SNA	
...4		3710-003374	CONNECTOR-SOCKET;64P,2R,0.5mm,ANGLE,NI+S	1	SA	
...4	EH01	3711-007742	HEADER-BOARD TO CABLE;BOX,20P,2R,2mm,ANG	1	SA	
...4	EH01	3711-008131	HEADER-BOARD TO CABLE;BOX,4P,1R,2.5mm,AN	1	SA	
...4	EH01	3711-008558	HEADER-BOARD TO CABLE;BOX,26P,2R,1.25mm,	1	SA	
...4		3722-003229	JACK-MODULAR;8P/8C W/L,Y,STRAIGHT,N,Au,1	1	SA	
...4		3722-003457	JACK-USB;4P/1C,NI,BLK,A	3	SA	
...4		3722-003546	JACK-PIN;5P+Screw hole,NI+SN,G,Y/BLU/RED	1	SA	
...4		3722-003617	JACK-PHONE;14P/2C,SN,BLK,STRAIGHT,3.6PI,	1	SA	
...4		3722-003655	JACK-SCART;21P,SN,BLK	1	SA	
...4	ET01	BN40-00256A	TUNER;DTOS40EIH035A,DTOS40EIH035A,DVB-TC	1	SA	
...4		BN41-01958A	PCB MAIN;X12, LED 6 Series,FR-4,4,A,1.2T	1	SNA	
...4		BN97-07121A	ASSY MICOM;X12-PM51-0011-130709,2013.07.	1	SNA	
...5		1107-002226	IC-NOR FLASH;W25Q40CLSSIP,4Mbit,SOIC,8P,	1	SNA	
...4		BN97-07122A	ASSY MICOM;T-MST12DEUC-XXXX,U85A,2012.11	1	SNA	

Level	Location No.	Code No.	Description & Specification	Q'ty	SA/SNA	Remark
...5		1107-002077	IC-NAND FLASH;KLM4G1FE3B-B001,4Gbyte,32G	1	SA	
...4		BN97-07123A	ASSY MICOM;T-MST12DEUS-1009,2013.06.19	1	SNA	
...5		0903-001863	IC-MICROCONTROLLER;WT61P807-RG48,LQFP,48	1	SNA	
...4		BN97-07278A	ASSY MICOM-BLASTER;Blaster-Version:3.03,	1	SNA	
...5		BN13-00063A	PLD;MAXQ610J,QFN,44	1	SNA	
..3		BN97-07143A	ASSY DRM-KEY;CI(BN46-00115J),HDCP(BN46-0	1	SNA	
...4		BN46-00109H	KEY CODE-CERTIFI;MAC,TV/AV,General	1	SNA	
...4		BN46-00110N	KEY CODE-CERTIFI;MIRACAST,TV,X12 /X13	1	SNA	
...4		BN46-00115J	KEY CODE-CERTIFI;CI+,TV,2013X,Euro	1	SNA	
1		BN92-11716A	ASSY P/MATERIAL;UF6000 37	1	SNA	
0.2		0203-001595	TAPE-OPP MASKING;OPP-2,0.075,75,800M,CLR	3	SNA	
0.2		6902-001671	BAG ROLL;HDPE/PE FOAM,T0.01/T0.3,W750,L3	2	SNA	
0.2		6922-000013	BAND PP;PP,W18,L2300/L2900,TRP	1	SNA	
0.2		BN01-00156A	FOIL-STRETCH-HOOD;UE42F5000,LLDPE*,T0.08	0	SNA	
0.2		BN63-11092A	COVER-SHEET NITRON;PS51F8500,PE,T4.0,W12	1	SNA	
0.2		BN69-08272A	CUSHION-SET;UF6200, 40 ,WW,EPS	1	SNA	
0.2		BN69-08430A	CUSHION-FRONT;UF7000 40,EPS,EXPORT	1	SNA	
..3		0103-005099	RESIN-EPS;BASF303,Natural,Natural	40	SNA	
0.2		BN69-09102A	PALLET-WOODEN;UE40F6510,WOOD,1290,1190,1	1	SNA	
1		BN92-13312H	ASSY LABEL;F6***	1	SNA	
0.2		BN68-04913E	LABEL-LED HIGHLIGHT STICKER;F8500,8000,7	1	SNA	
0.2		BN68-05118C	LEAFLET-03,QSG;UF6200 ~ UF6700,EU N.AFRI	1	SNA	
0.2	T0527	BP68-00052B	LABEL-00,RATING;FPTV,PET,T0.05,93,73	1	SNA	
1	ACCE1	BN92-13436C	ASSY ACCESSORY;F6320	1	SNA	
0.2		BN68-04916N	LABEL-01,STICKER;UF6P,EDC,PET,T0.1,60,12	1	SNA	
0.2	3DGLA	BN96-25614A	ASSY ACCESSORY 3D GLASSES;SSG-5100GB,In	1	SC	
0.2		BN96-29414T	ASSY ACCESSORY CABLE;UE40F6320AWXXH	1	SNA	
..3		3709-001791	CONNECTOR-CARD SLOT;64P,0.5mm,SMD-A,AU,P	1	SA	
..3	T0268	3903-000849	CBF-POWER CORD;DT,CEE,LP-21L,250V,2.5A,B	1	SA	
..3		4301-000121	BATTERY-MN;1.5V,R03,10.5x44.5m,7.5g,AAA	2	SNA	
..3	SCREW	6003-001782	SCREW-TAPTYPE;BH,+ ,B,M4,L12,ZPC(BLK),SWR	8	SA	
..3	REMO2	AA59-00790A	REMOCON;TM1250,49,3.0V,F6370, F6300, F62	1	SA	
..3	M9889	BN63-01798B	CLOTH-CLEAN;CLOTH,sea blue,ToC	1	SNA	
..3		BN69-08226C	BOX-ACCESSORY;E7000,PAPER,CCP 400g,NON-S	1	SNA	
..3		BN69-08449A	BAG VINYL;LDPE,0.04,L1000,W120	0	SNA	
..3		BN69-08472G	PAD ACCESSARY;ACCESSORY,CB,Black Paper 4	1	SNA	
..3		BN69-08751B	WRAP VINYL-SHRINK;STAND,PLASTIC OTHERS,P	0	SNA	
..3		BN96-15806B	ASSY HOLDER P-WIRE STAND;UE5500,NYLON,BL	1	SNA	
...4		BN61-04731D	BOSS-TAPE;AMBER,ACRYL,T1.1,W20.0mm,WHITE	0	SNA	
...4		BN61-05491C	HOLDER-WIRE STAND;UE5500,NYLON,BLK	1	SNA	
..3	FLIB	BN96-26652A	ASSY CABLE P;IR BLASTER,IR BLASTER CABL,	1	SA	
0.2		BN96-29416K	ASSY ACCESSORY MANUAL;UE40F6320AWXXH	1	SNA	
..3		6902-000476	BAG PE;LDPE,T0.03,W250,L350,TRP,Recycle,	1	SNA	
..3		BN68-03548J	LEAFLET-05,WARRANTY CARD;comm,Samsung,17	1	SNA	
..3		BN68-04735A	LABEL-E,PASS;ALL MODEL,ART PAPER 90G,50,	1	SNA	
..3		BN68-04881P	MANUAL USERS;UF6320,16LANGS,XH,W/P 80G,E	1	SNA	
..3		BN68-04972A	MANUAL FLYER-02,REGULATORY GUI;ALL,SAMSU	1	SNA	

ANNEX. Exploded View & Part List

Level	Location No.	Code No.	Description & Specification	Q'ty	SA/SNA	Remark
..3		BN68-05115F	LEAFLET-06,FITCH;UF6100,EUROPE,W/P 80G,I	1	SNA	
1		BN92-13438A	ASSY BOX;UF6300, 40	1	SNA	
0.2		BH68-00662A	LABEL BOX-01;ALL MODEL,ART PAPER,60,110,	1	SNA	
0.2		BN69-08522M	BOX-SET;40UF6320-QS,CB,A-01,SW3,YEL,W117	1	SNA	

1. Precautions

1-1. Safety Precautions

Follow these safety, servicing and ESD precautions to prevent damage and to protect against potential hazards such as electrical shock.

1-1-1. Warnings



For continued safety, do not attempt to modify the circuit board.
Disconnect the AC power and DC power jack before servicing.

1-1-2. Servicing the LED TV

1. When servicing the LED TV, Disconnect the AC line cord from the AC outlet.
2. It is essential that service technicians have an accurate voltage meter available at all times. Check the calibration of this meter periodically.

1-1-3. Fire and Shock Hazard

Before returning the monitor to the user, perform the following safety checks:

1. Inspect each lead dress to make certain that the leads are not pinched or that hardware is not lodged between the chassis and other metal parts in the monitor.
2. Inspect all protective devices such as nonmetallic control knobs, insulating materials, cabinet backs, adjustment and compartment covers or shields, isolation resistor/capacitor networks, mechanical insulators, etc.
3. Leakage Current Hot Check:

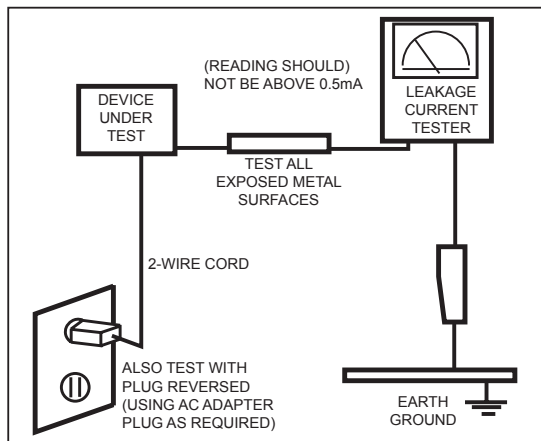

Do not use an isolation transformer during this test.

Use a leakage current tester or a metering system that complies with American National Standards Institute (ANSI C101.1, Leakage Current for Appliances), and Underwriters Laboratories (UL Publication UL1410, 59.7).

4. With the unit completely reassembled, plug the AC line cord directly into a 120V AC outlet. With the unit's AC switch first in the ON position and then OFF, measure the current between a known earth ground (metal water pipe, conduit, etc.) and all exposed metal parts, including: metal cabinets, screwheads and control shafts. The current measured should not exceed 0.5 milliamp. Reverse the power-plug prongs in the AC outlet and repeat the test.

1-1-4. Product Safety Notices

Some electrical and mechanical parts have special safetyrelated characteristics which are often not evident from visual inspection. The protection they give may not be obtained by replacing them with components rated for higher voltage, wattage, etc. Parts that have special safety characteristics are identified by  on schematics and parts lists. A substitute replacement that does not have the same safety characteristics as the recommended replacement part might create shock, fire and/or other hazards. Product safety is under review continuously and new instructions are issued whenever appropriate.

1-2. Servicing Precautions



An electrolytic capacitor installed with the wrong polarity might explode.



Before servicing units covered by this service manual, read and follow the Safety Precautions section of this manual.



If unforeseen circumstances create conflict between the following servicing precautions and any of the safety precautions, always follow the safety precautions.

1-2-1. General Servicing Precautions

1. Always unplug the unit's AC power cord from the AC power source and disconnect the DC Power Jack before attempting to: (a) remove or reinstall any component or assembly, (b) disconnect PCB plugs or connectors, (c) connect a test component in parallel with an electrolytic capacitor.
2. Some components are raised above the printed circuit board for safety. An insulation tube or tape is sometimes used. The internal wiring is sometimes clamped to prevent contact with thermally hot components. Reinstall all such elements to their original position.
3. After servicing, always check that the screws, components and wiring have been correctly reinstalled. Make sure that the area around the serviced part has not been damaged.
4. Check the insulation between the blades of the AC plug and accessible conductive parts (examples: metal panels, input terminals and earphone jacks).
5. Insulation Checking Procedure: Disconnect the power cord from the AC source and turn the power switch ON. Connect an insulation resistance meter (500 V) to the blades of the AC plug. The insulation resistance between each blade of the AC plug and accessible conductive parts (see above) should be greater than 1 megohm.
6. Always connect a test instrument's ground lead to the instrument chassis ground before connecting the positive lead; always remove the instrument's ground lead last.

1-3. Static Electricity Precautions

Some semiconductor (solid state) devices can be easily damaged by static electricity. Such components are commonly called Electrostatically Sensitive Devices (ESD). Examples of typical ESD are integrated circuits and some field-effect transistors. The following techniques will reduce the incidence of component damage caused by static electricity.

1. Immediately before handling any semiconductor components or assemblies, drain the electrostatic charge from your body by touching a known earth ground. Alternatively, wear a discharging wrist-strap device. To avoid a shock hazard, be sure to remove the wrist strap before applying power to the monitor.
2. After removing an ESD-equipped assembly, place it on a conductive surface such as aluminum foil to prevent accumulation of an electrostatic charge.
3. Do not use freon-propelled chemicals. These can generate electrical charges sufficient to damage ESDs.
4. Use only a grounded-tip soldering iron to solder or desolder ESDs.
5. Use only an anti-static solder removal device. Some solder removal devices not classified as "anti-static" can generate electrical charges sufficient to damage ESDs.
6. Do not remove a replacement ESD from its protective package until you are ready to install it. Most replacement ESDs are packaged with leads that are electrically shorted together by conductive foam, aluminum foil or other conductive materials.
7. Immediately before removing the protective material from the leads of a replacement ESD, touch the protective material to the chassis or circuit assembly into which the device will be installed.



CAUTION

Be sure no power is applied to the chassis or circuit and observe all other safety precautions.

8. Minimize body motions when handling unpackaged replacement ESDs. Motions such as brushing clothes together, or lifting your foot from a carpeted floor can generate enough static electricity to damage an ESD.

1-4. Installation Precautions

1. For safety reasons, more than a people are required for carrying the product.
2. Keep the power cord away from any heat emitting devices, as a melted covering may cause fire or electric shock.
3. Do not place the product in areas with poor ventilation such as a bookshelf or closet. The increased internal temperature may cause fire.
4. Bend the external antenna cable when connecting it to the product. This is a measure to protect it from being exposed to moisture. Otherwise, it may cause a fire or electric shock.
5. Make sure to turn the power off and unplug the power cord from the outlet before repositioning the product. Also check the antenna cable or the external connectors if they are fully unplugged. Damage to the cord may cause fire or electric shock.
6. Keep the antenna far away from any high-voltage cables and install it firmly. Contact with the highvoltage cable or the antenna falling over may cause fire or electric shock.
7. When installing the product, leave enough space (0.4m) between the product and the wall for ventilation purposes. A rise in temperature within the product may cause fire.

2. Product Specifications

2-1. Product information

Model	UE**F6320AW		
Front View	<p>* W : Width H : High D : Depth</p>		
Detail View			
Front Color	CLEAR BLACK		
Dimensions (W x H x D)	40"	Set with Stand	934.0 x 620.1 x 264.8 mm
		Set without Stand	934.0 x 548.6 x 49.6 mm
	46"	Set with Stand	1065.4 x 704.7 x 306.9 mm
		Set without Stand	1065.4 x 622.5 x 49.6 mm
	55"	Set with Stand	1256.0 x 811.2 x 306.9 mm
		Set without Stand	1256.0 x 729.3 x 49.2 mm
Weight	40"	Set with Stand	10.0 kg
		Set without Stand	8.9 kg
	46"	Set with Stand	13.5 kg
		Set without Stand	11.8 kg
	55"	Set with Stand	18.7 kg
		Set without Stand	17.0 kg
Panel Type	BLACK		
Internal Memory	4G		
DDR	1G		
Feature	3D / SMART HUB / Anynet+ (HDMI-CEC) / e-Manual / Device Manager / Screen Mirroring		

2-2. Product specification

2-2-1. Detailed Specifications

NOTE

Design and specifications are subject to change without prior notice.

	Item	UE**F6320AWXXH
General Information	Product	LED
	Series	6
	Country	HUNGARY
Display	Inch	40" / 46"
	Resolution	1,920 x 1,080
	Ultra Clear Panel	No
Video	Clear Motion Rate	200
	Micro Dimming	No
	Picture Engine	3D HyperReal Engine
	Dynamic Contrast Ratio	Mega Contrast
	Wide Color Enhancer (Plus)	Yes
	Film Mode	Yes
	Natural Mode Support	Yes
Audio	3D Sound	Yes
	Sound Output (RMS)	10 W x 2
	Dolby	Dolby Digital Plus / Dolby Pulse
	SRS / DNSe+	DTS Studio Sound
	dts 2.0 + Digital Out / DTS Premium Audio	DTS Premium Audio 5.1
	Speaker Type	Down Firing + Full Range
	Sound Customizer	No
	Woofers	No
Smart TV 2.0	Smart Hub	Yes
	On TV	Yes (AT,BE,CH,DE,DK,ES,FI,FR,UK,IR,IT,LU,NL,NO,PL,PT,SE)
	Movies & TV Shows	Yes (FR, DE, ES, SE, NL, AT, CH)
	Apps	Yes
	Social	Yes
	Photos, Videos & Music	Yes
	Fitness	Yes
	Kids	Yes
	ACR (Advertisement)	No
	Samsung SMART View	Yes (Clone View only)
	S Recommendation	Yes

	Item	UE**F6320AWXXH
Smart TV 2.0	Web Browser	Yes
Smart Interaction 2.0	Camera Built-in	No
	Face recognition	No
	Motion control	No
	Voice Control (Embedded)	No
	Voice Control (Server)	No
	Voice Interaction	No
	Camera App	No
	Samsung TV Apps supported	Yes
System	DTV Tuner	DVB-T/C
	Analog Tuner	Yes
	CI/CI+	CI+ (1.3)
Input&Output	Audio Out (Mini Jack)	No
	Component In (Y/Pb/Pr)	1
	Composite In (AV)	1 (Common Use for Component Y)
	Digital Audio Out (Optical)	1
	DVI Audio In (Mini Jack)	No
	Ethernet (LAN)	1
	HDMI	4
	PC Audio In (Mini Jack)	No
	PC In (D-sub)	No
	RF In (Terrestrial/Cable Input)	1
	RF In (Satellite Input)	No
	RS-232C (AV CONTROL)	No
	USB	3
	Headphone	1
	Scart	1
	CI Slot	1
IR Out	1	
Design	Design	One design
	Slim Type	Slim
	Bezel Type	Narrow Bezel
	Front Color	Black
	Light Effect (Deco)	No
	Swivel (Left/Right)	Yes
	Stand Type	Quad
	Push & Pull Camera	No

2. Product specifications

	Item	UE**F6320AWXXH
Feature	3D Converter	Yes
	ConnectShare™ (USB 2.0)	Movie
	Samsung 3D	Yes
	History	Yes
	MultiTasking	No
	Smart Evolution Support	No
	Wireless LAN Built-in	Yes
	Wireless LAN Adapter Support	No
	OSD Language	26 European Languages
	EPG	Yes
	HbbTV	Yes (CZ, PL, DE, AT, CH, BE, NL, LU, PT, FR, ES)
	HDMI 1.4 3D Auto Setting	Yes
	HDMI 1.4 A/Return Ch. Support	Yes
	Time Shift	Yes
	AllShare (Content Sharing, Screen Mirroring)	Yes
	Teletext (TTXT)	Yes
	InstaPort S (HDMI quick switch)	No
	Anynet+ (HDMI-CEC)	Yes
	Auto Channel Search	Yes
	Auto Power Off	Yes
	Auto Volume Leveler	Yes
	Caption (Subtitle)	Yes
	Clock&On/Off Timer	Yes
	Game Mode	Yes
	Sports Mode	Advanced
	Picture-In-Picture	Yes
	Sleep Timer	Yes
	Extended PVR	Yes
	Smart Phone Remote support	Yes
	WiFi Direct	Yes
	ISP Bound Service	Yes
	BT HID Built-in	Yes
USB HID Support	Yes	
Sound Share	Yes	
Digital Clean View	Yes	
MHL	No	
Twin Tuner	No	

Item		UE**F6320AWXXH
Feature	BD Wise Plus	Yes
	Embeded POP	Yes
Eco	Energy Efficiency Class	A+
	Eco Sensor	Yes
Accessory	3D Active Glasses (Included)	2 * SSG-5100GB
	IR Extender Cable (Included)	Yes
	Wireless LAN Adaptor (Included)	No
	MoIP Camera	No
	Wireless Keyboard	No
	Remote Controller Model	TM1240A
	Batteries (for Remote Control)	Yes
	Ultra Slim Wall Mount Supported	No
	Mini Wall Mount Supported	Yes
	Vesa Wall Mount Supported	Yes
	Slim Gender Cable	No
	Power Cable	Yes
	ANT-Cable	No
	User Manual	Yes
	E-Manual	Yes
Floor Stand Support	No	

2-2-2. Feature & Specifications

Model	UE40F6320AW
Feature	
<ul style="list-style-type: none"> Digital-TV, RF, 4-HDMI, 1-Component, 1-A/V (Common Use for Component Y), 3-USB2.0 (Media Play), LAN, Wi-Fi PIP(in HDMI 1, 2, 3, 4 Component and Sub picture is available only in TV mode (DTV/ATV)) Dolby Digital Plus Pulse, DTS Premium Sound 5.1, DTS Studio Sound 	
Specifications	
Item	Description
LCD Panel	40 inch FHD 120Hz
Display Colors	1.07 B
Active Display (H x V)* * Horizontal x Vertical	885.6 (H) x 498.15 (V) mm
Input Signal	Analog 0.7 Vp-p \pm 5% positive at 75 Ω , internally terminated
Input Signal Frequency	Horizontal : 31~80 kHz Vertical : 56 ~ 75 Hz
Input Sync Signal	H/V Separate, TTL, P. or N.
Maximum Resolution	Horizontal : 1920 Pixels Vertical : 1080 Pixels
Maximum Pixel Clock Rate	138 MHz
AC Power Voltage & Frequency	AC100-240V 50/60Hz
Power Consumption	122W
Environmental Considerations	Operating Temperature : 50°F ~ 104°F (10°C ~ 40°C) Operating Humidity : 10% ~ 80%, non-condensing Storage Temperature : -4°F ~ 113°F (-20°C ~ 45°C) Storage Humidity : 5% ~ 95%, non-condensing
Audio Specifications	MAX Internal Audio Output Power : Each 10 W (Left/Right) Equalizer : 5 Band Output Frequency : RF : 20 Hz ~ 15.4 kHz AV/Componet/HDMI : 20 Hz ~ 20 kHz

Model	UE46F6320AW
Feature	
<ul style="list-style-type: none"> Digital-TV, RF, 4-HDMI, 1-Component, 1-A/V (Common Use for Component Y), 3-USB2.0 (Media Play), LAN, Wi-Fi PIP(in HDMI 1, 2, 3, 4 Component and Sub picture is available only in TV mode (DTV/ATV)) Dolby Digital Plus Pulse, DTS Premium Sound 5.1, DTS Studio Sound 	
Specifications	
Item	Description
LCD Panel	46 inch FHD 120Hz
Display Colors	1.07 B
Active Display (H x V)* * Horizontal x Vertical	1018.08 (H) x 572.67 (V) mm
Input Signal	Analog 0.7 Vp-p \pm 5% positive at 75 Ω , internally terminated
Input Signal Frequency	Horizontal : 31~80 kHz Vertical : 56 ~ 75 Hz
Input Sync Signal	H/V Separate, TTL, P. or N.
Maximum Resolution	Horizontal : 1920 Pixels Vertical : 1080 Pixels
Maximum Pixel Clock Rate	138 MHz
AC Power Voltage & Frequency	AC100-240V 50/60Hz
Power Consumption	128W
Environmental Considerations	Operating Temperature : 50°F ~ 104°F (10°C ~ 40°C) Operating Humidity : 10% ~ 80%, non-condensing Storage Temperature : -4°F ~ 113°F (-20°C ~ 45°C) Storage Humidity : 5% ~ 95%, non-condensing
Audio Specifications	MAX Internal Audio Output Power : Each 10 W (Left/Right) Equalizer : 5 Band Output Frequency : RF : 20 Hz ~ 15.4 kHz AV/Componet/HDMI : 20 Hz ~ 20 kHz

2. Product specifications

Model	UE55F6320AW
Feature	
<ul style="list-style-type: none"> Digital-TV, RF, 4-HDMI, 1-Component, 1-A/V (Common Use for Component Y), 3-USB2.0 (Media Play), LAN, Wi-Fi PIP(in HDMI 1, 2, 3, 4 Component and Sub picture is available only in TV mode (DTV/ATV)) Dolby Digital Plus Pulse, DTS Premium Sound 5.1, DTS Studio Sound 	
Specifications	
Item	Description
LCD Panel	55 inch FHD 120Hz
Display Colors	1.07 B
Active Display (H x V)* * Horizontal x Vertical	1209.6 (H) x 680.4 (V) mm
Input Signal	Analog 0.7 Vp-p \pm 5% positive at 75 Ω , internally terminated
Input Signal Frequency	Horizontal : 31~80 kHz Vertical : 56 ~ 75 Hz
Input Sync Signal	H/V Separate, TTL, P. or N.
Maximum Resolution	Horizontal : 1920 Pixels Vertical : 1080 Pixels
Maximum Pixel Clock Rate	138 MHz
AC Power Voltage & Frequency	AC100-240V 50/60Hz
Power Consumption	TBDW
Environmental Considerations	Operating Temperature : 50°F ~ 104°F (10°C ~ 40°C) Operating Humidity : 10% ~ 80%, non-condensing Storage Temperature : -4°F ~ 113°F (-20°C ~ 45°C) Storage Humidity : 5% ~ 95%, non-condensing
Audio Specifications	MAX Internal Audio Output Power : Each 10 W (Left/Right) Equalizer : 5 Band Output Frequency : RF : 20 Hz ~ 15.4 kHz AV/Componet/HDMI : 20 Hz ~ 20 kHz



2-3. Accessories



NOTE

- The items' colors and shapes may vary depending on the model.
- Check that there is no accessory hidden behind packing materials when you open the box.
- The part code for some accessories may differ depending on your region.

Product	Code. No	Product	Code. No
• Remote Control	AA59-00790A	• Warranty Card	-
• Batteries (AAA x 2)	4301-000121	• Regulatory Guide	BN68-04972A
• Power Cord	3903-000849	• Samsung 3D Active Glasses	BN96-25614A
• User Manual	BN68-04881P (40", 46") BN68-05566E (55")		

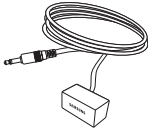
Image	Product	Code. No
	• Holder-Wire stand	BN61-08370A
	• Holder-Ring (Depending on the Model)	-
	• CI Card Adapter	3709-001791
	• IR Extension Cable	BN96-26652B

2-4. Viewing the Functions

2-4-1. Auto Motion Plus 120Hz

■ Function Naming

- 120Hz FRC + MJC : Auto Motion Plus 120Hz

■ Detail Specifications

Function (OSD)	120Hz FRC	Judder reduction (only 24p source)	Blur reduction
Off	Off (repeat)	Off	Off
Clear	ON (interpolation)	Off	High
Standard	ON (interpolation)	Medium	Medium
Smooth	ON (interpolation)	High	High
Custom	Level variable (0~10)		
Demo	Demo (Standard / Off)		

■ 120Hz Motion Enhancement



Off



Low / Medium / High



Demo

2-4-2. Supported Formats

■ Supported Subtitle Formats

External

Name	File Extension
MPEG-4 Timed text	Timed text .txt
SAMI	.smi
SubRip	.srt
SubViewer	.sub
Micro DVD	.sub or .txt
SubStation Alpha	.ssa
Advanced SubStation Alpha	.ass
Powerdivx	.psb

Internal

Name	Container
Xsub	AVI
SubStation Alpha	MKV
Advanced SubStation Alpha	MKV
SubRip	MKV
MPEG-4 Timed text	MP4

■ Supported image resolutions

File Extension	Type	Resolution
*.jpg, *.jpeg	JPEG	15360 x 8640
*.png	PNG	4096 x 4096
*.bmp	BMP	4096 x 4096
*.mpo	MPO	15360 x 8640

■ Supported Music File Formats

File Extension	Type	Codec	Comments
*.mp3	MPEG	MPEG1 Audio Layer 3	
*.m4a *.mpa *.aac	MPEG4	AAC	
*.flac	FLAC	FLAC	Supports up to 2 channel
*.ogg	OGG	Vorbis	Supports up to 2 channel
*.wma	WMA	WMA	WMA 10 Pro supports up to 5.1 channel. WMA lossless audio is not supported. Supports up to M2 profile (except LBR mode)
*.wav	wav	wav	
*.mid , *.midi	midi	midi	type 0, type 1 are supported.
*.ape	ape	ape	

■ Video Codec

File Extension	Container	Video Codec	Resolution	Frame rate (fps)	Bit rate (Mbps)	Audio Codec	
*.avi *.mkv *.asf *.wmv *.mp4 *.3gp *.vro *.mpg *.mpeg *.ts *.tp *.trp *.mov *.flv *.vob *.svi *.m2ts *.mts *.divx	AVI MKV ASF MP4 3GP MOV FLV VRO VOB PS TS SVAF	Divx 3.11 / 4 / 5 / 6	1920 x 1080	6~30	30	AC3 LPCM ADPCM(IMA, MS) AAC HE-AAC WMA DD+ MPEG(MP3)	
		MPEG4 SP/ASP					
		H.264 BP/MP/HP					
		Motion JPEG	640 x 480		8		
		Microsoft MPEG-4 v3	1920 x 1080 (WMV v7, v8, MSMPEG4 v3: 1280x720)				
		Window Media Video v7, v8, v9					
		MPEG2			30		
		MPEG1					
		MVC			24/25/30		60
		VP6	640 x 480				4
		*.webm	WebM		VP8		1920 x1080

■ Other Restrictions

Codecs may not function properly if there is a problem with the content data.

Video content does not play or does not play correctly if there is an error in the content or container.

Sound or video may not work if they have standard bit rates/frame rates above the TV's compatibility ratings.

If the Index Table is wrong, the Seek (Jump) function does not work.

When playing video over a network connection, the video may not play smoothly because of data transmission speeds.

Some USB/digital camera devices may not be compatible with the player.

■ Video Decoders

- Supports up to H.264, Level 4.1 (does not support FMO/ASO/RS)
- VC1 AP L4 is not supported.
- All video codecs excluding WMV v7, v8, MSMPEG4 v3, MVC, and VP6:
 - Below 1280 x 720: 60 frame max
 - Above 1280 x 720: 30 frame max
- GMC is not supported.
- Supports SVAF top/bottom and left/right only.
- Supports Blu-ray/DVD MVC specs only.

■ Audio Decoders

- WMA 10 Pro supports up to 5.1 channels. Supports up to M2 profile.
- WMA lossless audio is not supported.
- QCELP, AMR NB / WB is not supported.
- Vorbis is supported for up to 2 channels.
- DD+ is supported for up to 5.1 channels.

2-4-3. Remote Control

Learn where the function buttons are on your remote. Especially note these: **SOURCE**, **MUTE**, **Y**, **< P >**, **MENU**, **TOOLS**, **E**, **INFO**, **CH LIST**, **RETURN**, **GUIDE** and **EXIT**.

 **NOTE**

This remote control has Braille points on the Power, Chanel, and Volume buttons and can be used by visually impaired persons.

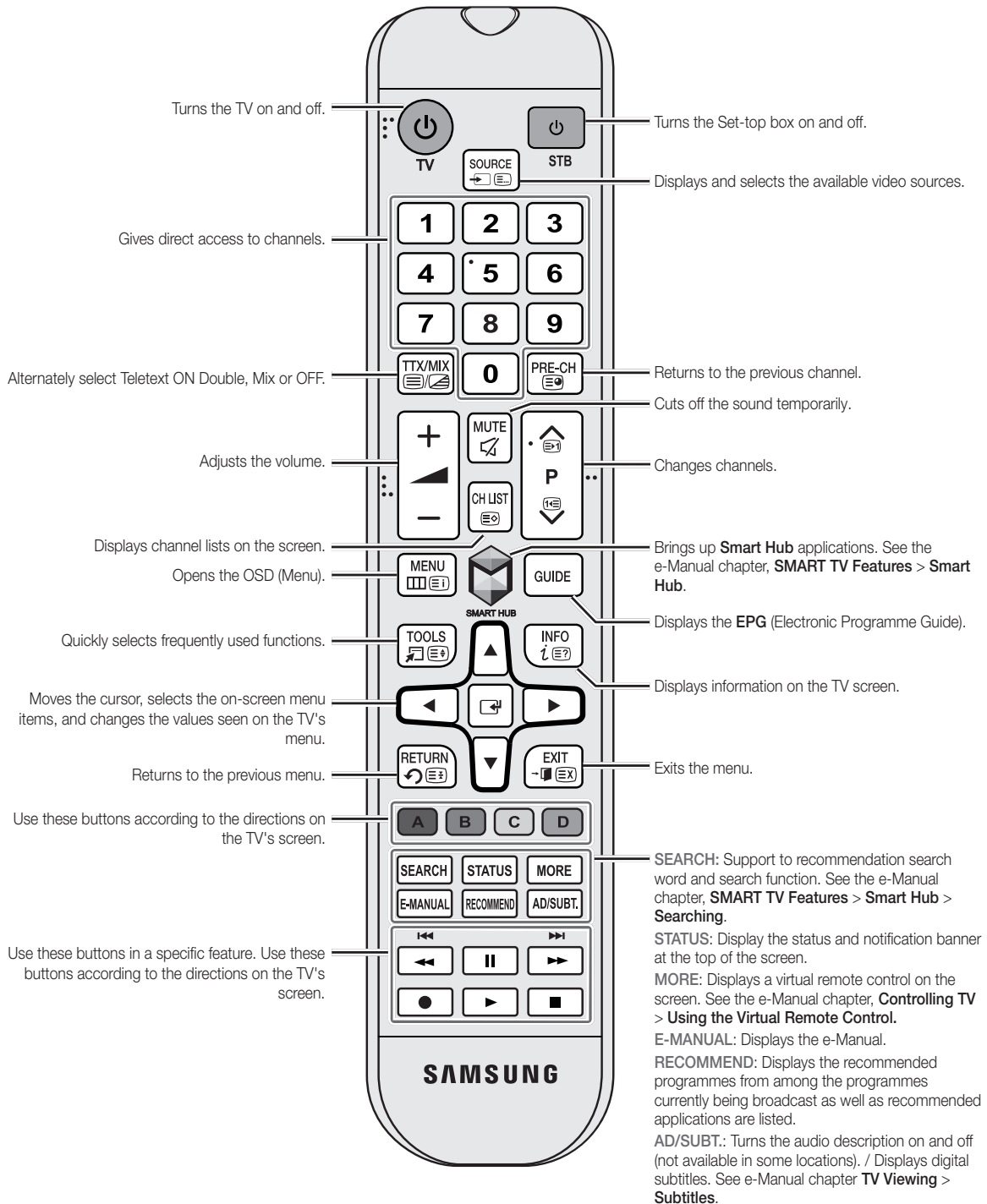

2-4-4. Universal Remote Control Setup

This TV has a universal remote control feature that lets you control cable boxes, Blu-ray players, home theatres, and other third-party external devices connected to the TV using the TV's remote control.



NOTE

Some or new models of the external device connected to the TV, may not be supported the **Universal remote setup**.

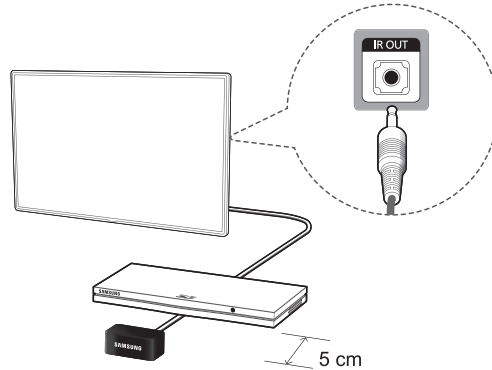

Keep a distance of 5 cm at least between the IR Extender and the external device, as the illustration shows. Face the IR Extender toward the external device's remote control signal receiver. Note that it should be no obstacle between IR Extender and external device. The presence of an obstacle will interfere with the transmission of the remote control signal.

■ Add the External Device

1. Turn on the external device you wish to set up universal remote function for and then press **SOURCE** to bring up the **Source** screen.
2. Select **Universal remote setup** from the top of the screen. This initiates the universal remote setup process.
3. Follow the on-screen instruction and set up the universal remote control. If it does not work, set up the remote control by entering the model number manually.

2-4-5. SMART HUB

This TV features Smart Hub, a multi-purpose entertainment and family center. With Smart Hub, users can surf the web, download applications, and stay in touch with family and friends through social networking services. In addition, you can enjoy photo, video, and music files stored on external storage devices.

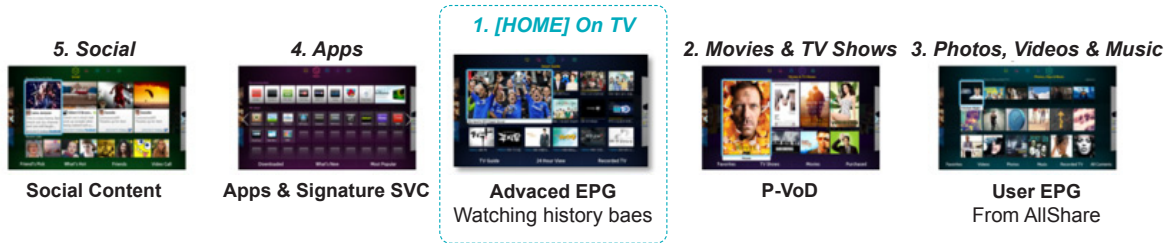

On TV

This functions is only available on U.S and Canada.
While you watch TV, a list of recommended programs on other channels appears on the screen. You can use this list to change the channel and find out more information about the recommended programs including how much time is left until they air.

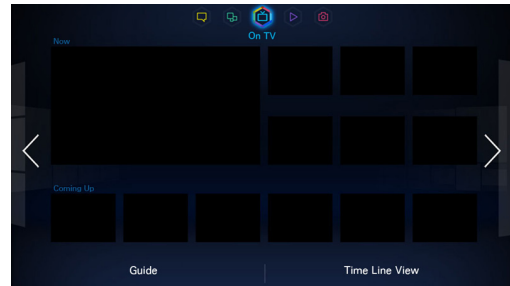

Movies & TV Shows

Purchase and watch movies and series without a separate external device.

This functions is only available on U.S and Canada.
Users can buy movies and TV shows online.
Open Smart Hub and select Movies & TV Shows.
This service may be not available depending on the country or region.

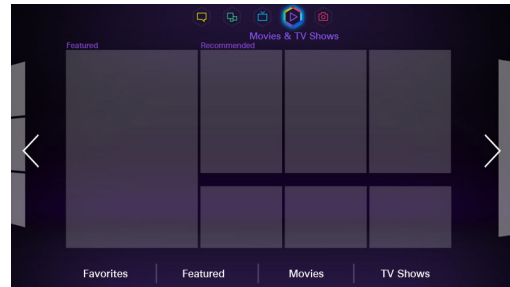

Photos, Videos & Music

Play back photo, video, and music files from an external storage device.

Open Smart Hub and select Photos, Videos & Music.
Enjoy photo, video and music files from an external storage device directly on your TV. Back up important files before connecting an external storage device to the TV. Samsung will not be held responsible for damaged or lost files.

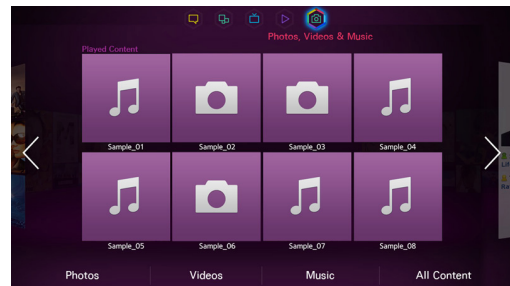

2. Product specifications

Social

Watch the latest YouTube videos and you and your friends' video posts on Facebook and Twitter. You can also make video calls to friends by connecting the TV to a camera (sold separately).

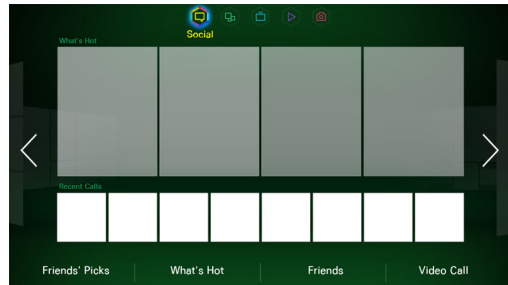

Apps

Download and install applications such as WebBrowser and Family Tree.

Samsung Apps offers an extensive collection of free and paid news, sports, weather, and gaming content you can directly download to and enjoy on your TV. First, check the network and make sure the TV is connected to the Internet. Your TV needs to be connected to the Internet in order to use Apps.

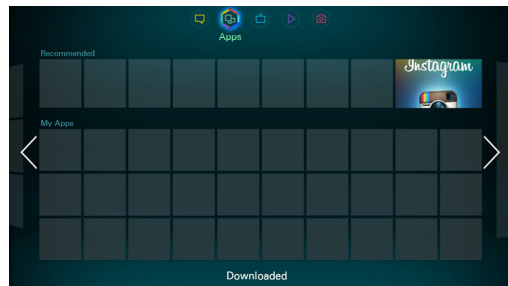

- **Samsung Apps**
Samsung Apps offers various free and paid news, sports, weather, and gaming applications. Samsung Apps lets you search for applications and install them directly on your TV. Read and agree to the terms and conditions of use and then browse through the categories or directly search for applications.
- **Fitness**
Fitness is an application that helps you stay fit. Create a profile, set up an exercise plan, and start exercising according to a structured regimen. Read and agree to the terms and conditions before using Fitness.
- **Kids**
This is a quick launcher and recommended list for applications and content that is suitable for children and even provides services not currently installed on your TV. Using Kids, you can download applications and content for your children to your TV. Certain services, however, are fee-based.
- **WebBrowser**
WebBrowser is a web-browsing application. Using WebBrowser, you can browse the Internet on your TV as you would on your computer and even watch TV while you surf the web. The browsing experience, however, may not be the same as it is on your computer. Use a keyboard and mouse for a more convenient web browsing experience.
- **Social Networks**
Share your thoughts and comments about a program on the air through social networking services. Social Networks displays social network services such as Twitter, Facebook, Google Talk, and NateOn on a single screen. You can even post messages and comments in the same manner as you would using a computer. You must first link your Samsung account to the respective SNS accounts before you can access them using Social Networks.

2-4-6. 3D Display

■ What is 3D Display?

This mode is to enable users to view images on the TV/Monitor in 3D by receiving the video signal in 3D format from sources such as 3D games and titles. The human brain constructs a 3 dimensional image from the two images entering both eyes. The depth of a 3 dimensional images is determined by the horizontal difference between the images from both the left and right eyes. 3D is displayed two images alternately on screen equivalent to left and right at TV, and embodied by doing to see each relevant image in left eye and right eye through shutter glasses.

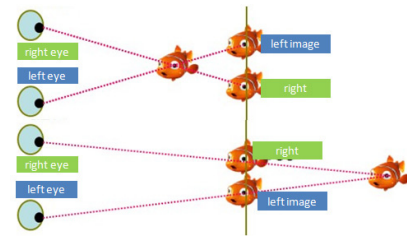

■ 3D Function of Model Series

LCD / LED / PDP TV		LED	
Items	Sub Items	120Hz	
	Platform (Main)	X12	
	Platform (FRC / Formatter)	Fox-FT1 (SDC) Fox-FT2 (AUO / CMI) Echo-Fs (Sharp 3D) NT7231 2 (Sharp 2D)	
3D Feature	2D → 3D Coversion	O	
	3D → 2D	O	
	3D Perspective	O	
	3D Depth	O	
	Auto View (Auto Format Detection)	X	
	3D Optimize	O	
FRC Feature	Auto Motion Plus	O	
3D Input Format	ATV / AV, PC	2D → 3D	O
	Component	2D → 3D	O
		SS, TB	O
	HDMI	2D → 3D	O
		SS, TB	O
		FP 1080P 24 / 25 / 30 FP 720P 50 / 60 FP 1080i 50 / 60	O
		HDMI (PC / DVI)	LL, VS, Check ker BD, FS
	HDMI (PC / DVI)	2D → 3D	O
		SS, TB	O
		MPO	O
		SVAF IES (SS, BT)	O
		MVC 1080P 24 / 25 /30 MVC 720P 50 / 60 MVC 1080i 50 / 60 MVC 720P 24 / 25 /30	O
		DTV	2D → 3D
	DTV	SS, TB	O
		DVB_PhaseI (SS, BT)	O
		ATSC_KR30	O

■ Supported 3D Resolutions

These specifications apply to a display ratio of 16:9 only.

- 3D Format: L/R, T/B

Resolution	Frequency (Hz)
1280 x 720p	59.94 / 60
1920 x 1080i	59.94 / 60
1920 x 1080p	23.98 / 24 / 29.97 / 30 / 59.94 / 60

- 3D Format: Frame Packing

Resolution	Frequency (Hz)
1280 x 720p	59.94 / 60
1920 x 1080i	59.94 / 60
1920 x 1080p	23.98 / 24 / 29.97 / 30

- Component



Resolution	Frequency (Hz)
1280 x 720p	59.94 / 60
1920 x 1080i	59.94 / 60
1920 x 1080p	23.98 / 24 / 29.97 / 30 / 59.94 / 60

- Digital Channel

Resolution	Frequency (Hz)
1280 x 720p	59.94 / 60
1920 x 1080i	59.94 / 60

■ 3D Format Test

3D Format : There are several 3D formats existing on how to merge Left and Right images.

Format	Input images	Test Method
Frame Packin (HDMI 1.4)		Able to test only by HDMI 1.4 BD Player or MSPG-4600MT(Master Device)
Top & Bottom		Using Format_test.bmp <ul style="list-style-type: none"> • Check in the PC(HDMI) source. PC resolution and format resolution must be same • Wearing 3D glass, left eye sees only 'L' letter, right eye sees only 'R' letter (close your eyes one by one)
Side by Side		Using Format_test.bmp <ul style="list-style-type: none"> • Check in the PC(HDMI) source. PC resolution and format resolution must be same • Wearing 3D glass, left eye sees only 'L' letter, right eye sees only 'R' letter (close your eyes one by one)
2D → 3D		Check in the normal 2D source. Check not in the test pattern but in the actual video. <ul style="list-style-type: none"> • Left/Right black region will grow more and more as the depth goes higher.

4. Troubleshooting

4-1. Troubleshooting

4-1-1. Previous Check

1. Check the various cable connections first.
 - Check to see if there is a burnt or damaged cable.
 - Check to see if there is a disconnected or loose cable connection.
 - Check to see if the cables are connected according to the connection diagram.
2. Check the power input to the Main Board.

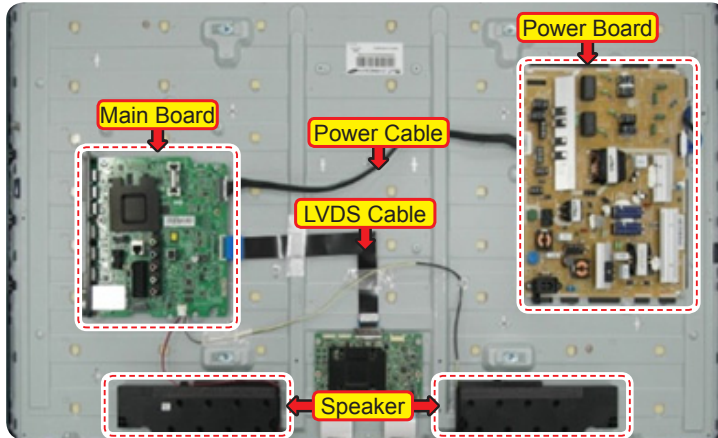

3. How to distinguish if the problem is caused by **Main Board** or **T CON**
 - No Video
If the problem is No Video but BLU is on and Indication LED is blinking repeatedly and faster than normal booting, replace the T-CON board.
 - Distorted Picture
Check the inner patterns.

- For All mode

X12	FOX_FT1 FRC Post	Picture	Problem
OK	OK	NG	Main Board or Signal Source
NG	OK	NG	Main Board
NG	NG	NG	Main Board or LVDS cable or T CON or Panel

- Only for HDMI mode (additional check)

HDMI	Picture	Problem
OK	NG	There is no problems after HDMI IC check HDMI source or HDMI jack.
NG	NG	There is no problems before HDMI IC check X12 pattern or LVDS cable or T CON

■ How to check inner pattern?

1. Enter the service mode → Choose 'SVC' → Check the 'internal pattern.'

2. Enter 'Service Mode.'

- If you do not have Factory remote control



- If you have Factory remote control



3. Choose 'SVC → Test pattern'.



4. Check inner patterns.

4-1-2. Simple flow chart of malfunction

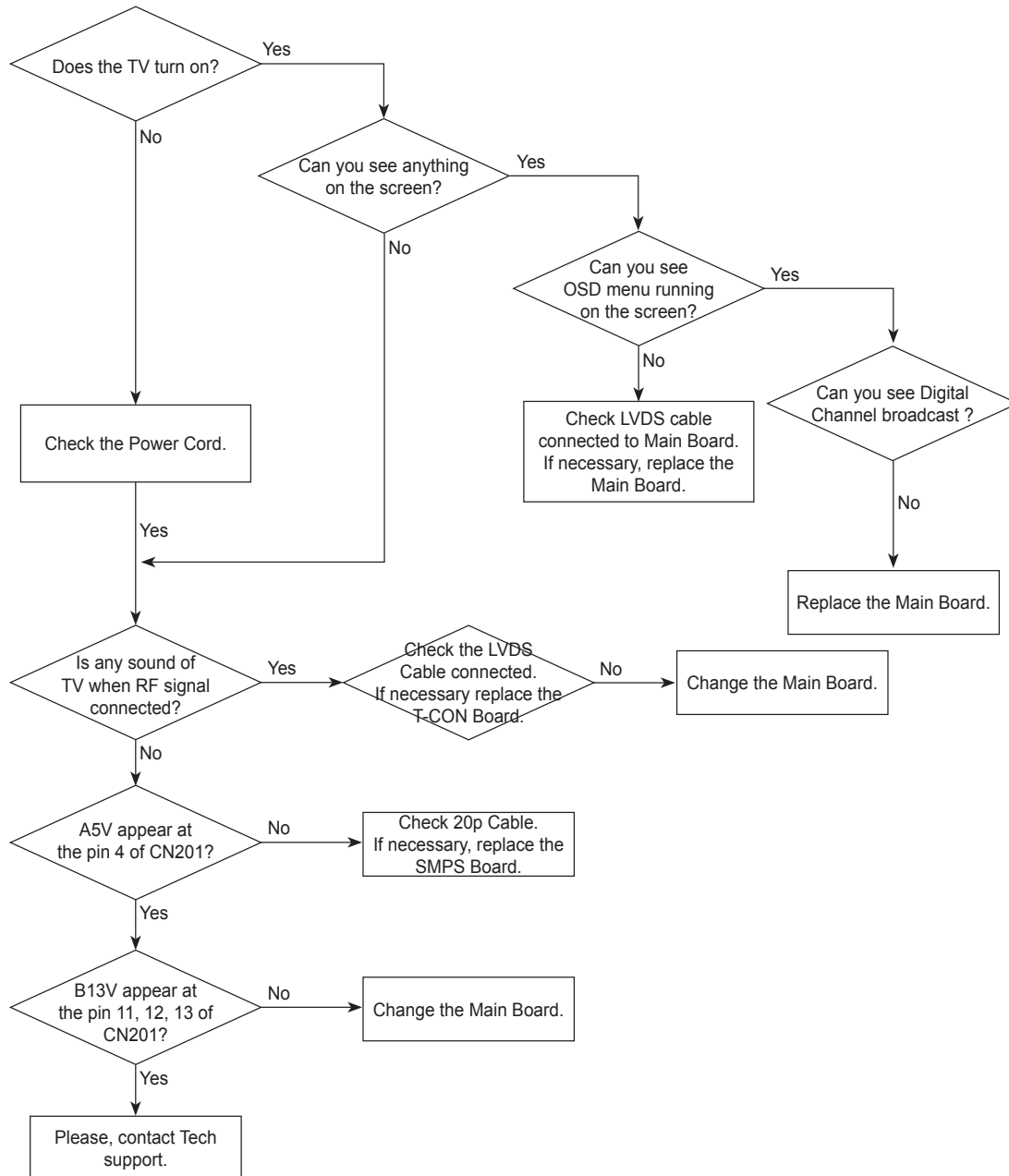

4-2. How to Check Fault Symptom

4-2-1. NO Power



Note

Refer to the next page to check the location such a CN201 or IC201 SVC Manual mentioned.

<p>Symptom</p>	<ul style="list-style-type: none"> • The LEDs on The front panel do not work when connecting The power cord. • The SMPS relay does not work when connecting The power cord. • The units appears to be dead.
<p>Major checkpoints</p>	<p>The IP relay or the LEDs on the front panel does not work when connecting the power cord if the cables are improperly connected or the Main Board or SMPS is not functioning. In this case, check the following:</p> <ul style="list-style-type: none"> • Check the internal cable connection status inside the unit. • Check the fuses of each part. • Check the output voltage of SMPS. • Replace the Main Board.
<p>Diagnostics</p>	<pre> graph TD Q1[Power indicator LED is on?] -- No --> A1[Check the power cord connection.] Q1 -- Yes --> Q2[Check the backlight on, when 20 PIN cable unconnected?] Q2 -- No --> A2[Change 20p cable. Change Main Power Ass'y.] Q2 -- Yes --> Q3[Check 'Stand-By 5V' ? BD207 : A5.3V] Q3 -- No --> A2 Q3 -- Yes --> Q4[Check 'Power input of Main Ass'y' ? - BD206 / BD201 : B12VS - BD214 / 209 : B13V - BD208 / BD213 : B5V] Q4 -- No --> A2 Q4 -- Yes --> Q5[Check 'Power IC output of Main Ass'y' ? - IC202 : A3.3V - L202 : B1.15V / L201 : B5V - L203 : B3.3V / BD211 : B1.5V] Q5 -- No --> A3[Change the Main Ass'y.] Q5 -- Yes --> Q6[Check Input power of 'T CON Board' ? - F1(T CON) : B13V] Q6 -- No --> A4[Reconnect or Change. the LVDS cable.] Q6 -- Yes --> Q7[Check Power of 'T CON Board'. - BD1(T CON) : Panel_12V - B1.1V(T CON-TP) : FT1_1.1V_PW] Q7 -- No --> A5[Change the T CON Board.] </pre>

Diagnostics	<p style="text-align: center;">↓ Yes ↓</p> <div style="border: 1px solid black; padding: 5px; margin: 0 auto; width: fit-content;">Please, Contact tech support.</div>
Caution	Make sure to disconnect the power before working on the IP Board.

■ Location of Parts

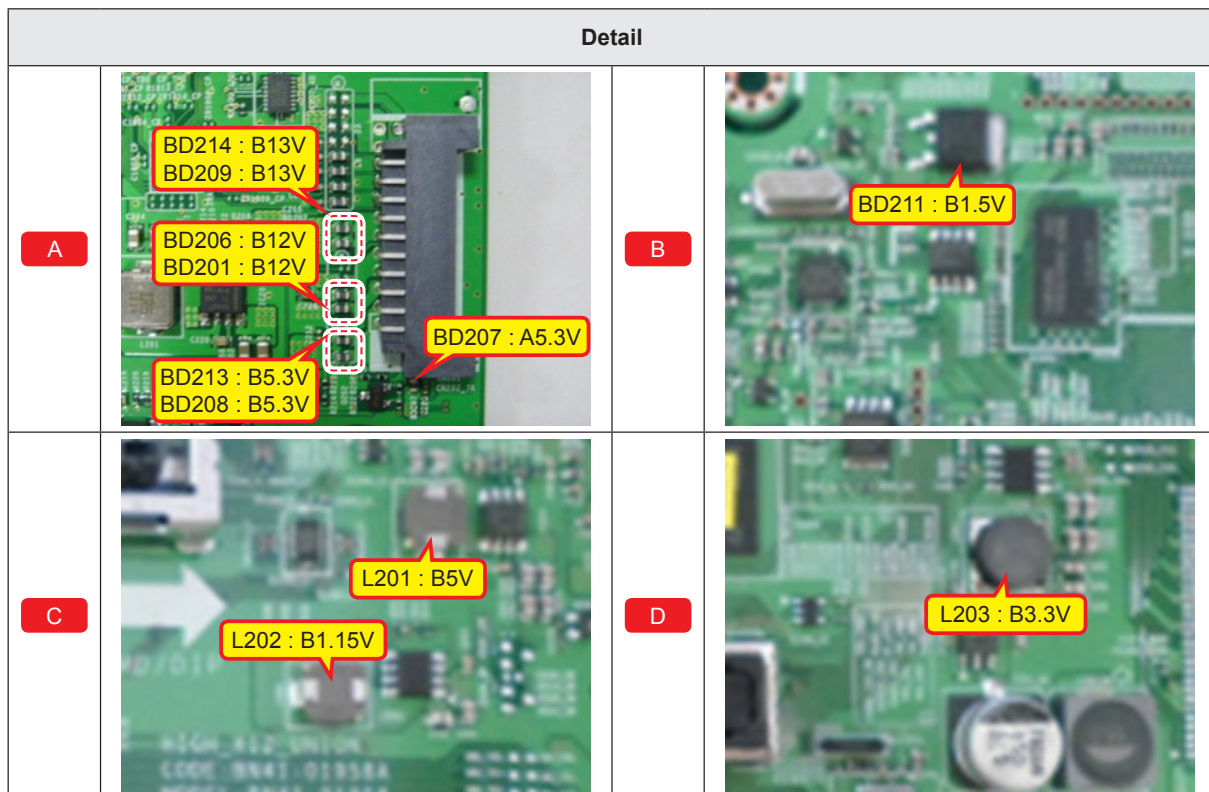
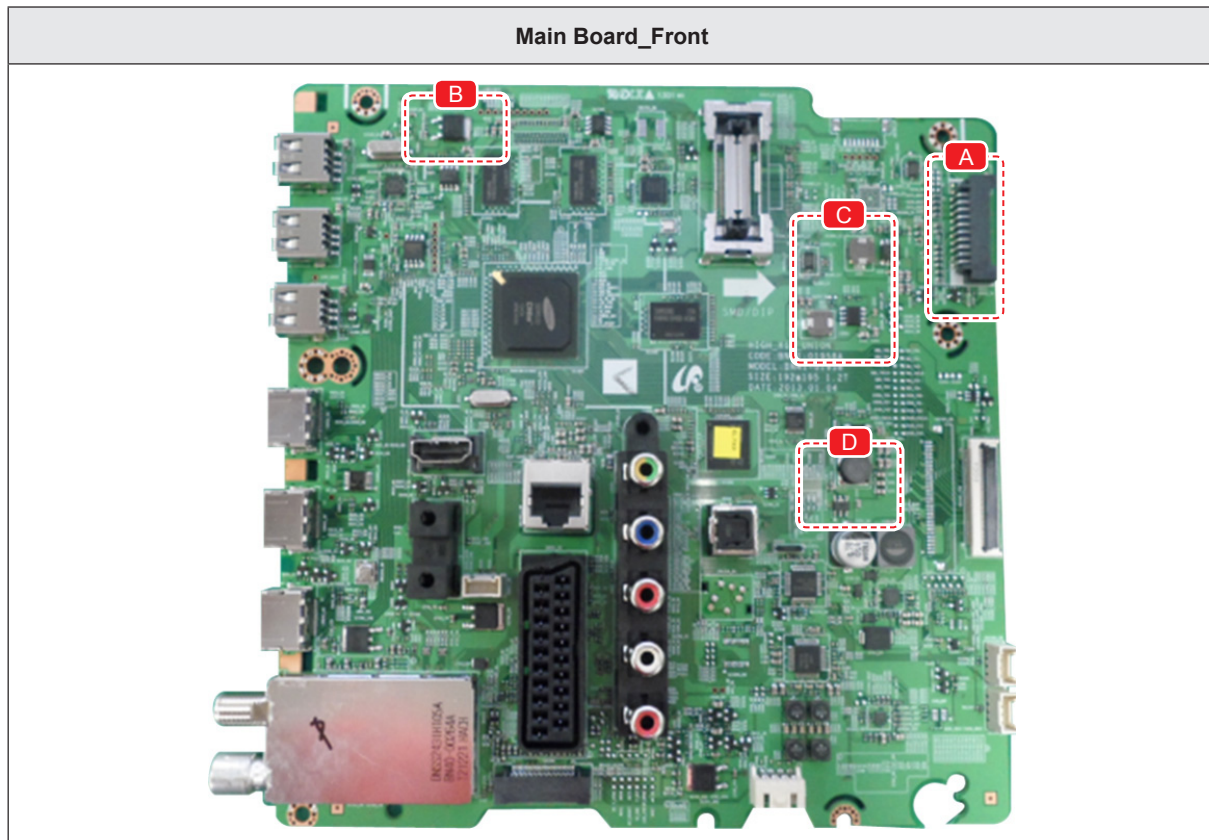

4-2-2. No Video (HDMI 1, 2, 3, 4 - Digital Signal)



Note

Refer to the next page to check the location such a CN201 or IC201 SVC Manual mentioned.

Symptom	<ul style="list-style-type: none"> • Audio is normal but no picture is displayed on the screen.
Major checkpoints	<ul style="list-style-type: none"> • Check the HDMI source. • Check the HDMI switch. • This may happen when the LVDS cable connecting the Main Board and the Panel is disconnected.
Diagnostics	<pre> graph TD Q1[Power indicator LED is off. Lamp(Backlight) on, no video ?] -- No --> A1[Check a set in the 'Stand-by mode'.] Q1 -- Yes --> Q2[Check the HDMI source and check the connection of HDMI cable ?] Q2 -- No --> A2[Input the HDMI signal properly.] Q2 -- Yes --> Q3[Check the signal at Input of Main Board ? - HDMI1 Clk Pin #10, #12 of CN602_H2 • DATA Pin #7, #9, #4, #6, #1, #3 of CN602_H2 - HDMI2 Clk Pin #10, #12 of CN603_H3 • DATA Pin #7, #9, #4, #6, #1, #3 of CN603_H3 - HDMI3 Clk Pin #10, #12 of CN604_H4 • DATA Pin #7, #9, #4, #6, #1, #3 of CN604_H4 - HDMI4 Clk Pin #10, #12 of CN601_H1 • DATA Pin #7, #9, #4, #6, #1, #3 of CN601_H1] Q3 -- No --> A3[Check CN601~4. Check HDMI cable. Change the Main Ass'y. or Check IC1001(X12). Change the Main Ass'y.] Q3 -- Yes --> Q4[Check the LVDS clk signal at output of Main Board. (TX) - TX2_CLK : ODD_TXCLK_DN/DP - TX4_CLK : EVEN_TXCLK_DN/DP] Q4 -- No --> A4[Check IC1001(X12). Change the Main Ass'y.] Q4 -- Yes --> Q5[Check the LVDS cable? Replace the T CON / LCD panel?] Q5 -- No --> A5[Please, Contact tech support.] </pre> <p>1</p> <p>2</p>
Caution	<p>Make sure to disconnect the power before working on the IP Board.</p>

■ Location of Parts

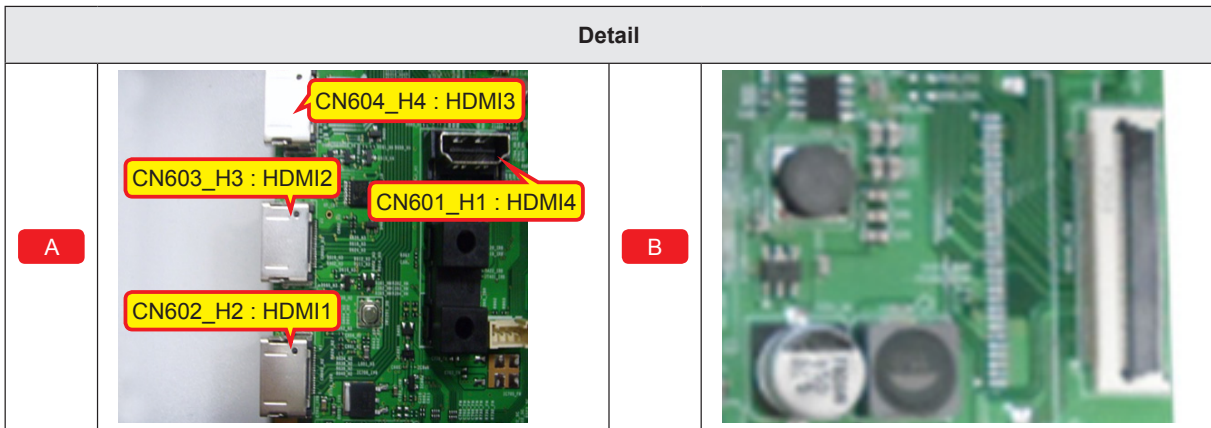
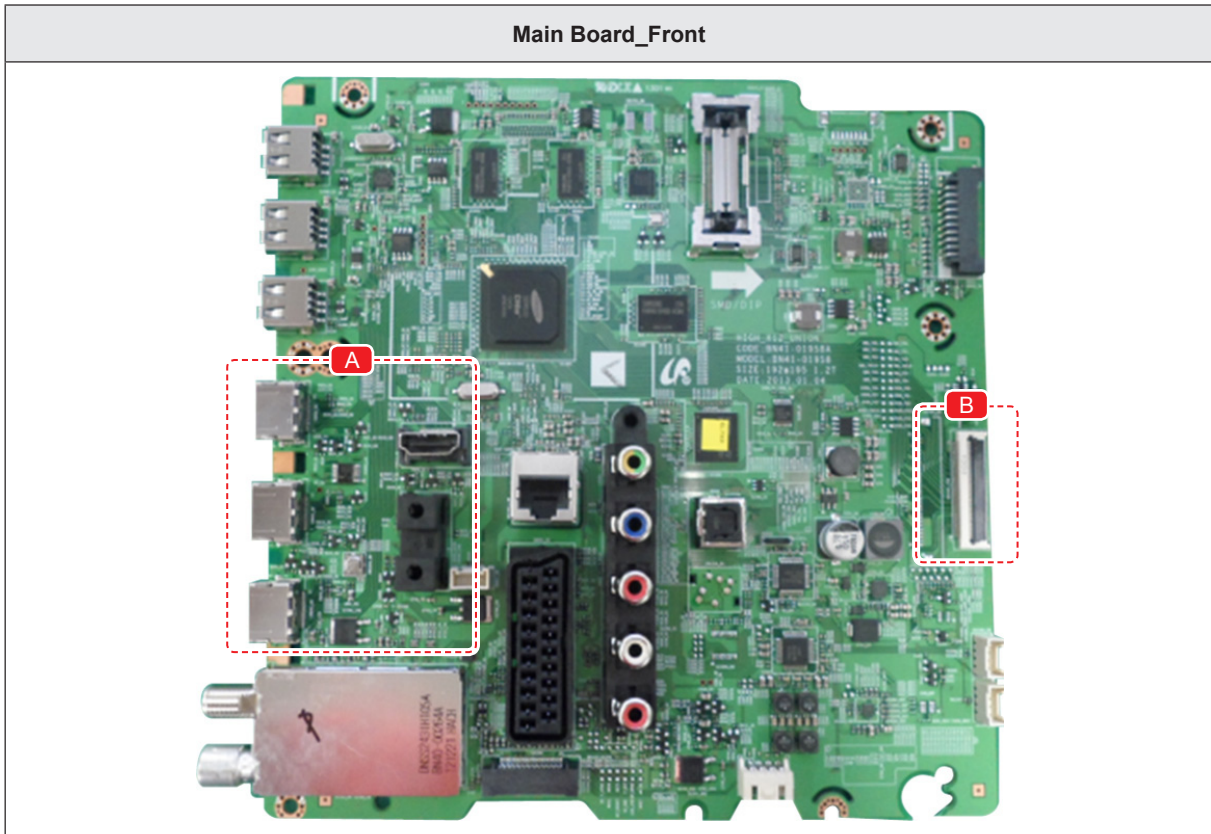

■ Waveforms

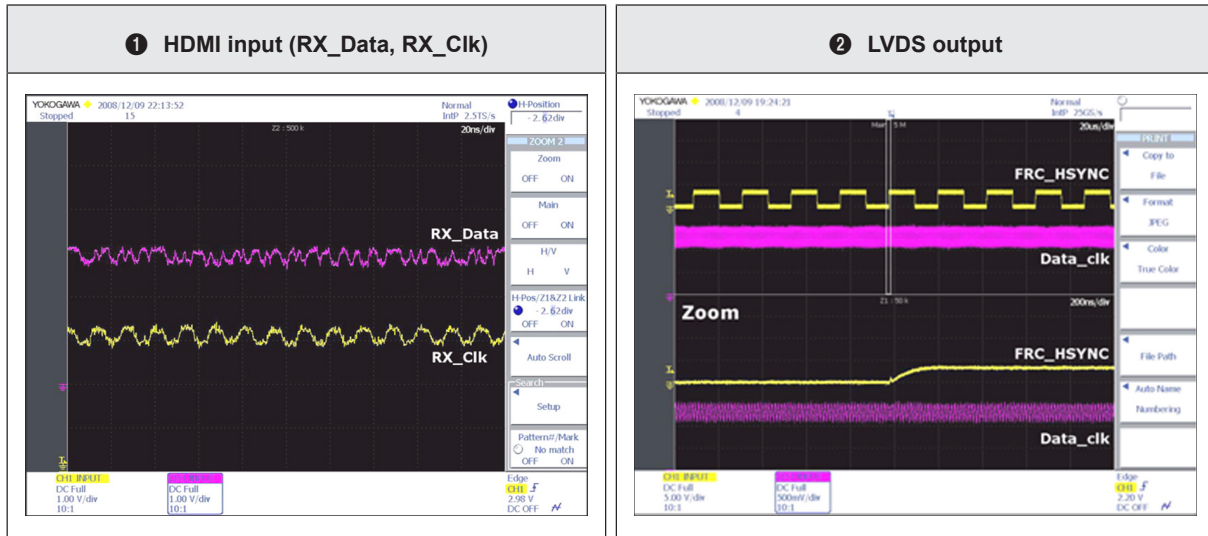

4-2-3. No Video (Tuner_CVBS)



Note

Refer to the next page to check the location such a CN201 or IC201 SVC Manual mentioned.

Symptom	<ul style="list-style-type: none"> • Audio is normal but no picture is displayed on the screen.
Major checkpoints	<ul style="list-style-type: none"> • Check the Tuner CVBS source. • Check the Tuner. • This may happen when the LVDS cable connecting the Main Board and the Panel is disconnected.
Diagnostics	<pre> graph TD Q1[Power indicator LED is off. Lamp(Backlight) on, no video ?] -- No --> A1[Check a set in the 'Stand-by mode'.] Q1 -- Yes --> Q2[Check the RF source and check the connection of RF cable.] Q2 -- No --> A2[Input the RF source properly.] Q2 -- Yes --> Q3[1 Check the Power of Tuner ? - Pin #4 of Tuner : B3.3V_Tuner - Pin #1 of Tuner : B1.8V_Tuner] Q3 -- No --> A3[Change the Main Ass'y.] Q3 -- Yes --> Q4[2 Check the CVBS data out of IC1001 ? C807 : Tuner CVBS] Q4 -- No --> A4[Check IC1001(X12). Change the Main Ass'y.] Q4 -- Yes --> Q5[2 Check the LVDS clk signal at output of Main board. (TX) - TX2_CLK : ODD_TXCLK_DN/DP - TX4_CLK : EVEN_TXCLK_DN/DP] Q5 -- No --> A5[Check IC1001(X12). Change the Main Ass'y.] Q5 -- Yes --> Q6[Check the LVDS cable? Replace the T CON / LCD panel?] Q6 -- No --> A6[Please, Contact tech support.] </pre>
Caution	Make sure to disconnect the power before working on the IP Board.

Location of Parts

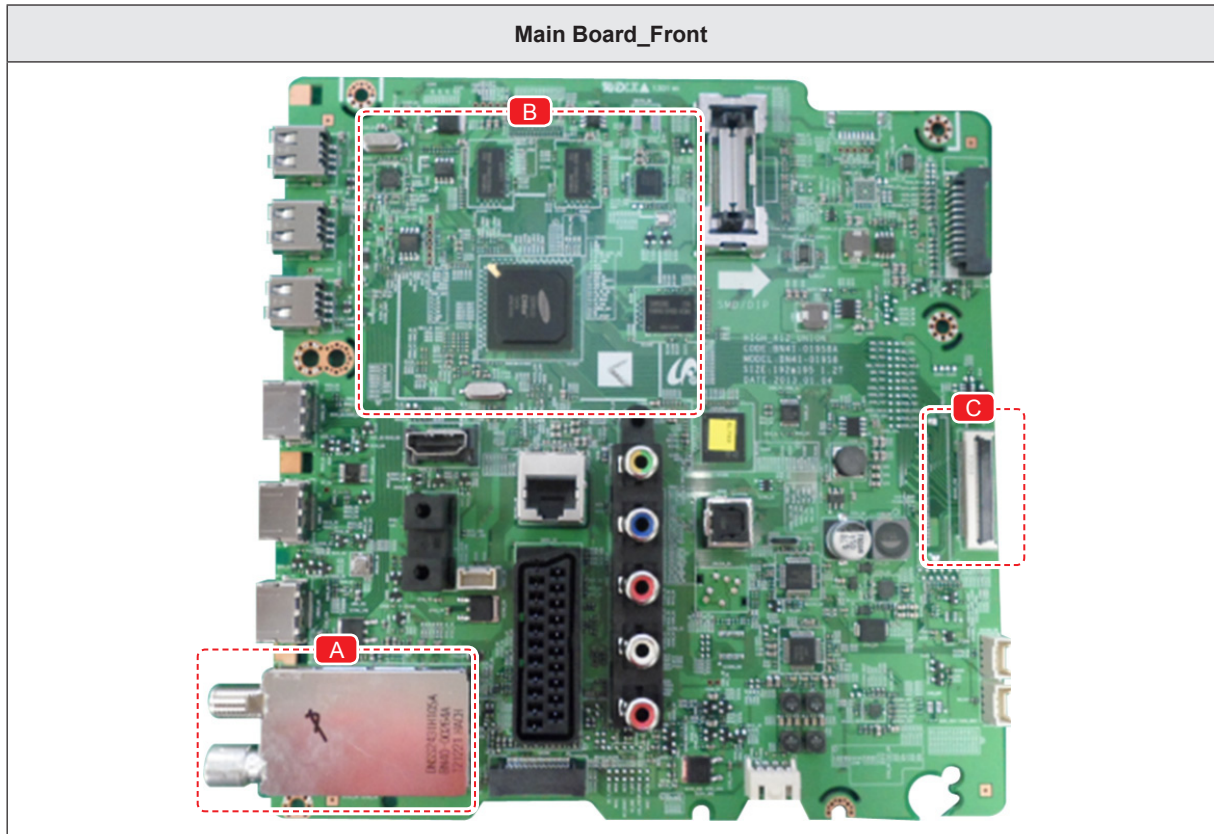

Detail

<p style="text-align: center;">A</p>	<p>Pin #4 : B3.3V</p> <p>Pin #1 : B1.8V</p>	<p style="text-align: center;">B</p>	<p>C807</p>
<p style="text-align: center;">C</p>			

■ Waveforms

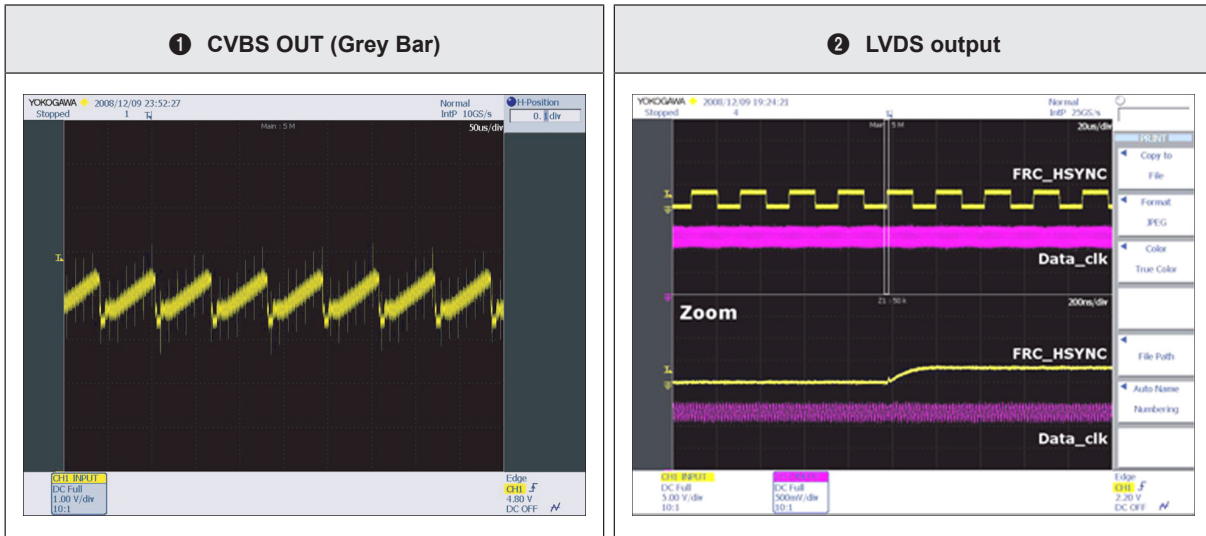

4-2-4. No Vido (Tuner DTV)



Note

Refer to the next page to check the location such a CN201 or IC201 SVC Manual mentioned.

Symptom	<ul style="list-style-type: none"> • Audio is normal but no picture is displayed on the screen.
Major checkpoints	<ul style="list-style-type: none"> • Check the DTV source. • Check the Tuner. • This may happen when the LVDS cable connecting the Main Board and the Panel is disconnected.
Diagnostics	<pre> graph TD Q1[Power indicator LED is off. Lamp(Backlight) on, no video?] -- No --> A1[Check a set in the 'Stand-by mode'.] Q1 -- Yes --> Q2[Check the RF source and check the connection of RF cable.] Q2 -- No --> A2[Input the RF source properly.] Q2 -- Yes --> Q3[1 Check the 'signal strength' in Self Diagnosis menu Strength is enough?] Q3 -- No --> A3[Check the D-TV source.] Q3 -- Yes --> Q4[2 Check the Power of Tuner ? - Pin #4 of Tuner : B3.3V_Tuner - Pin #1 of Tuner : B1.8V_Tuner] Q4 -- No --> A4[Change the Main Ass'y.] Q4 -- Yes --> Q5[2 Check the LVDS clk signal at output of Main board. (TX) - TX2_CLK : ODD_TXCLK_DN/DP - TX4_CLK : EVEN_TXCLK_DN/DP] Q5 -- No --> A5[Check IC1001(X12) Change the Main Ass'y.] Q5 -- Yes --> Q6[Check the LVDS cable? Replace the T CON / LCD panel?] Q6 -- No --> A6[Please, Contact tech support.] </pre>
Caution	<p>Make sure to disconnect the power before working on the IP Board.</p>

■ Location of Parts

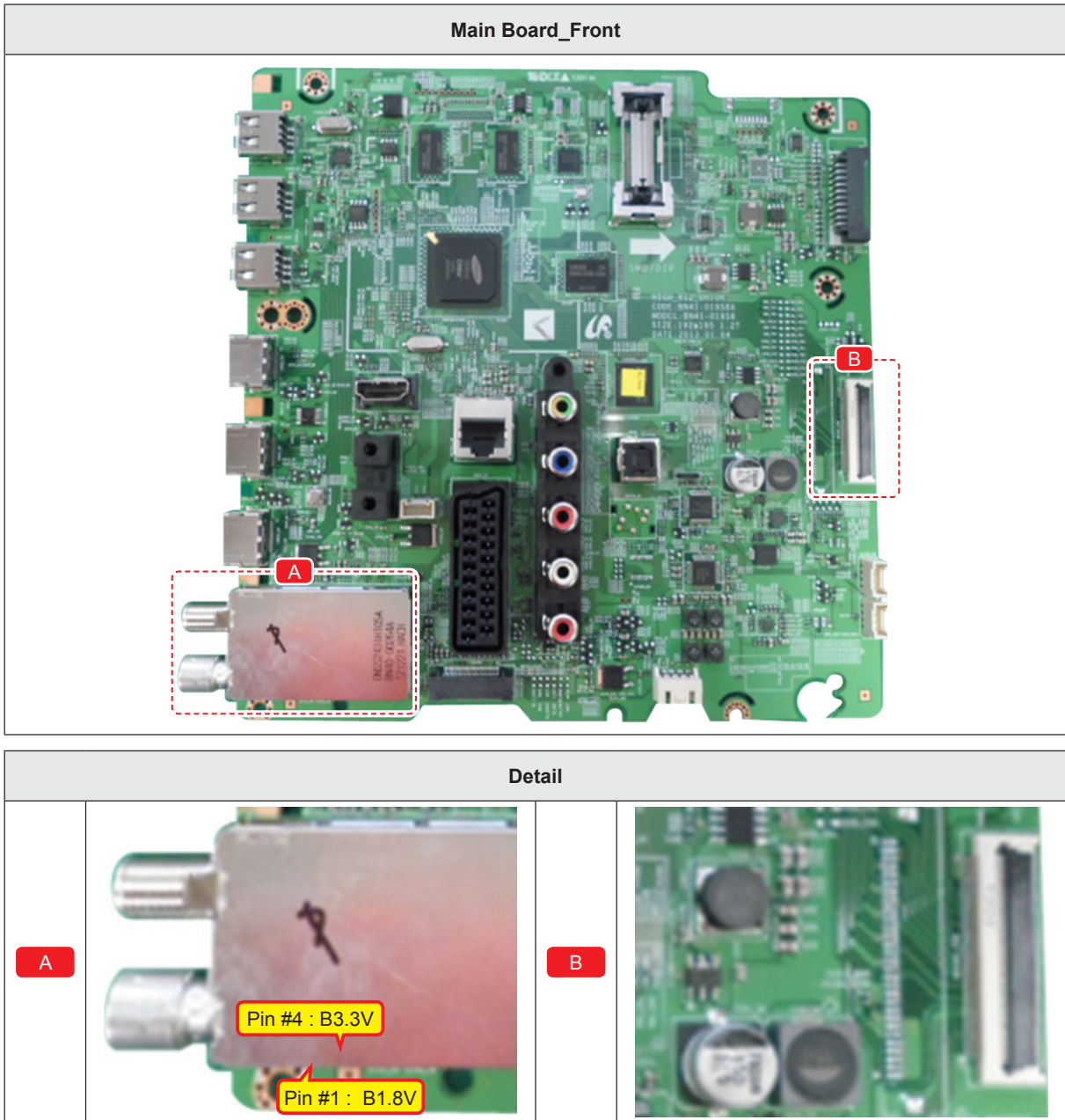

■ Waveforms

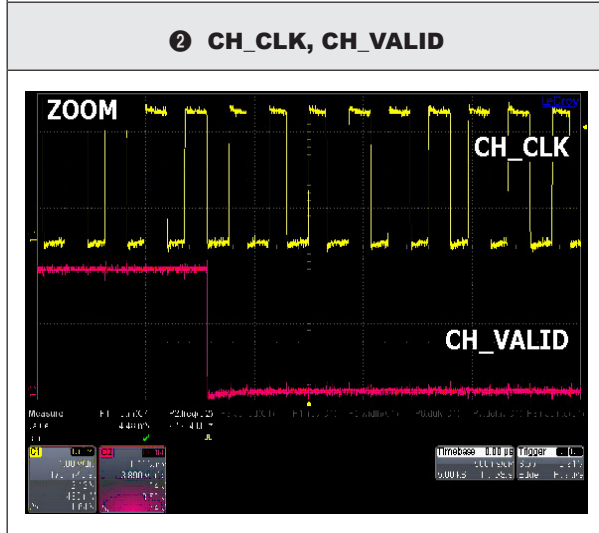
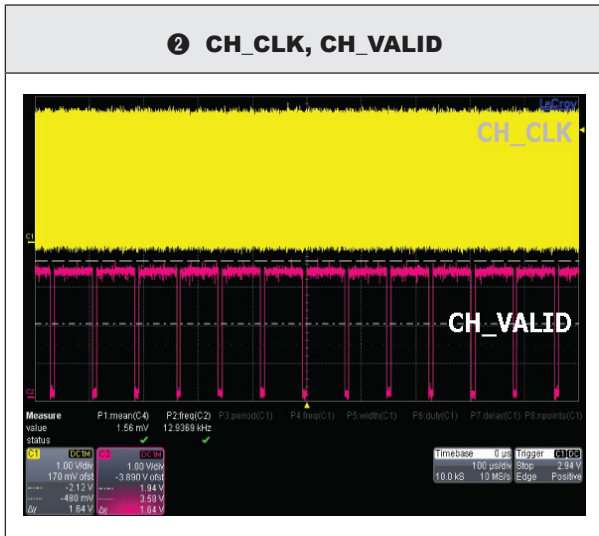
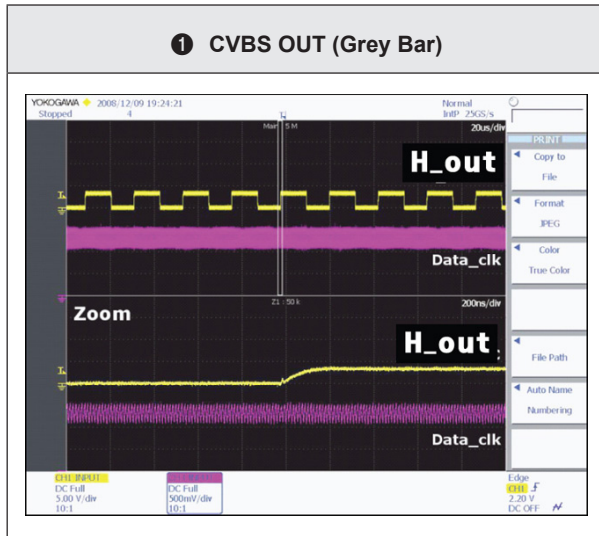

4-2-5. No Video (Video AV)



Note

Refer to the next page to check the location such a CN201 or IC201 SVC Manual mentioned.

Symptom	<ul style="list-style-type: none"> • Audio is normal but no picture is displayed on the screen.
Major checkpoints	<ul style="list-style-type: none"> • Check the Video CVBS source. • This may happen when the LVDS cable connecting the Main Board and the Panel is disconnected.
Diagnostics	<pre> graph TD Q1[Power indicator LED is off. Lamp(Backlight) on, no video ?] -- No --> A1[Check a set in the 'Stand-by mode'.] Q1 -- Yes --> Q2[Check the video source and check the connection of video cable?] Q2 -- No --> A2[Input the video source properly.] Q2 -- Yes --> Q3[Check the LVDS clk signal at output of Main board. (TX) - TX2_CLK : ODD_TXCLK_DN/DP - TX4_CLK : EVEN_TXCLK_DN/DP] Q3 -- No --> A3[Check IC1001(X12) Change the Main Ass'y.] Q3 -- Yes --> Q4[Check the LVDS cable? Replace the T CON / LCD panel?] Q4 -- No --> A4[Please, Contact tech support.] </pre>
Caution	<p>Make sure to disconnect the power before working on the IP Board.</p>

■ Location of Parts

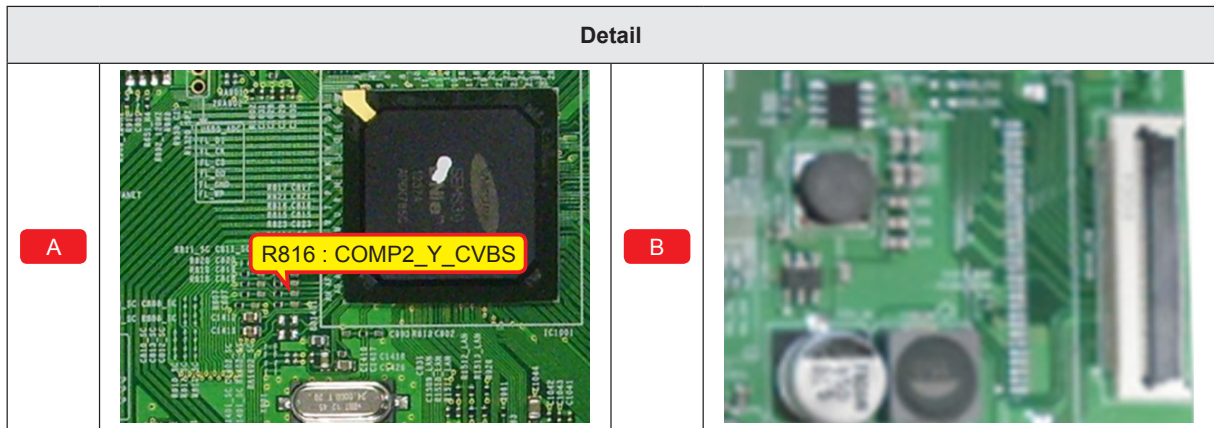
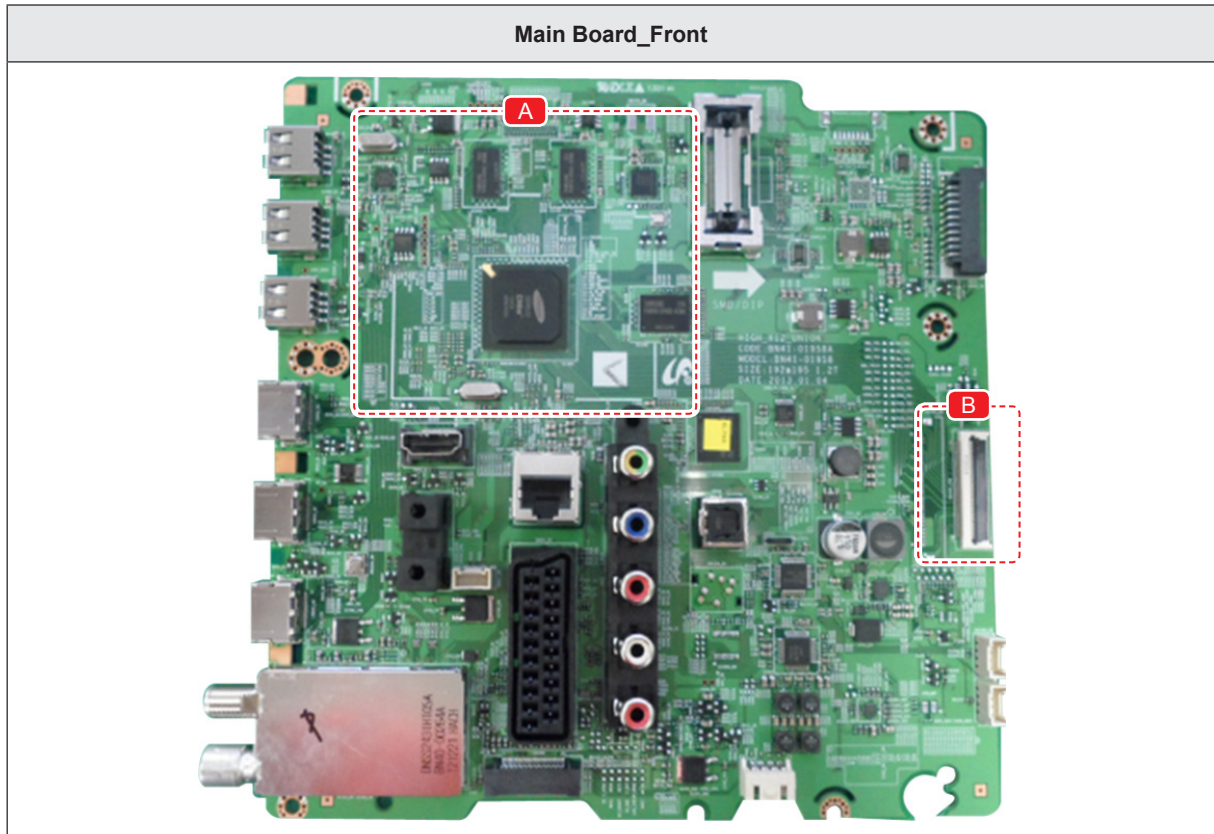

4. Troubleshooting

■ Waveforms

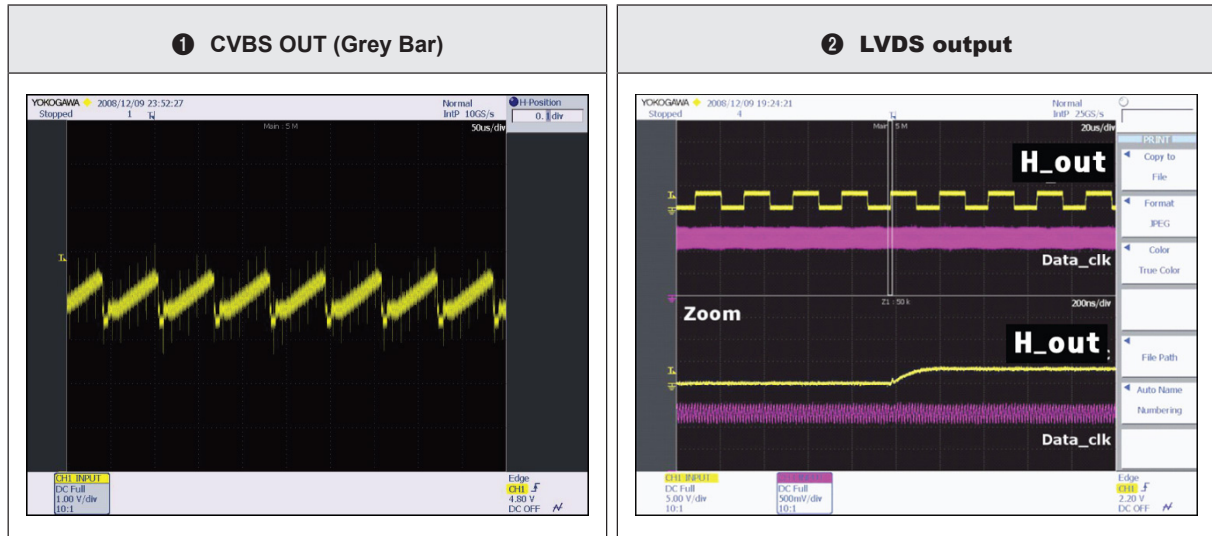

4-2-6. No Video (COMPONENT)



Note

Refer to the next page to check the location such a CN201 or IC201 SVC Manual mentioned.

Symptom	<ul style="list-style-type: none"> • Audio is normal but no picture is displayed on the screen.
Major checkpoints	<ul style="list-style-type: none"> • Check the Component source • This may happen when the LVDS cable connecting the Main Board and the Panel is disconnected.
Diagnostics	<pre> graph TD Q1[Power indicator LED is off. Lamp(Backlight) on, no video?] -- No --> A1[Check a set in the 'Stand-by mode'.] Q1 -- Yes --> Q2[Check the component source and check the connection of component cables? Y, Pb, Pr] Q2 -- No --> A2[Input the component source properly.] Q2 -- Yes --> Q3[Does the component data appear at? - COMP2_Y_CVBS : R816 - Pb : R817 - Pr : R815] Q3 -- No --> A3[Check CN502. Change the Main Ass'y.] Q3 -- Yes --> Q4[Check the LVDS clk signal at output of Main Board. (TX) - TX2_CLK : ODD_TXCLK_DN/DP - TX4_CLK : EVEN_TXCLK_DN/DP] Q4 -- No --> A4[Check IC1001(X12). Change the Main Ass'y.] Q4 -- Yes --> Q5[Check the LVDS cable? Replace the T CON / LCD panel?] Q5 -- No --> A5[Please, Contact tech support.] </pre>
Caution	<p>Make sure to disconnect the power before working on the IP Board.</p>

■ Location of Parts

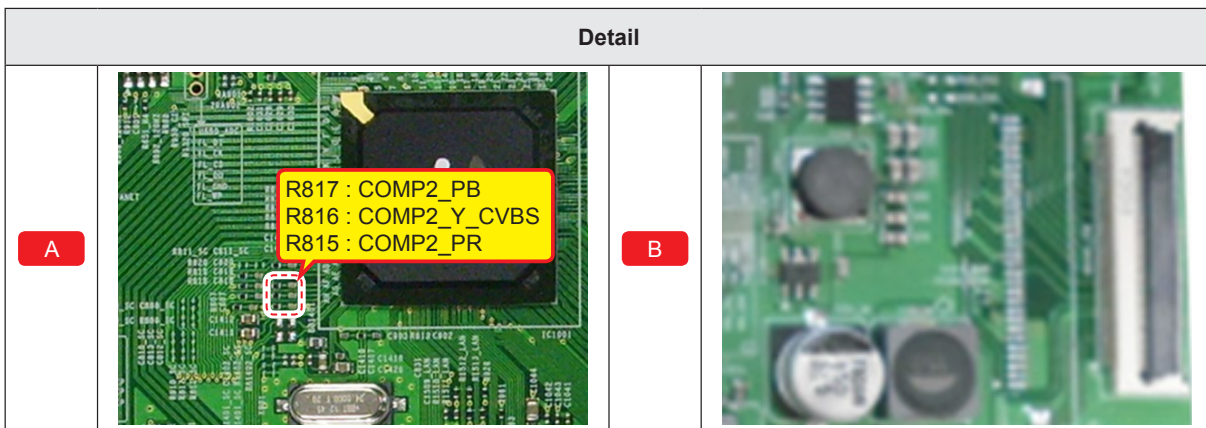
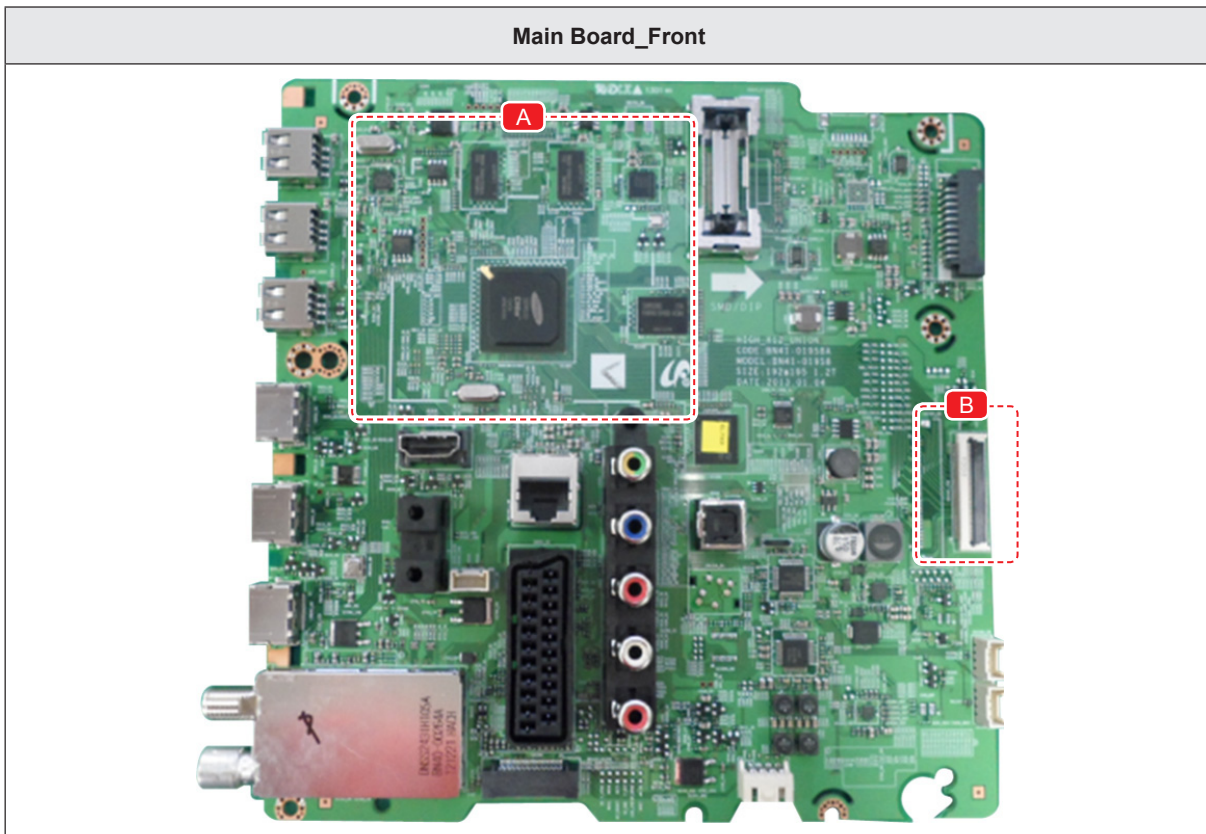

■ Waveforms

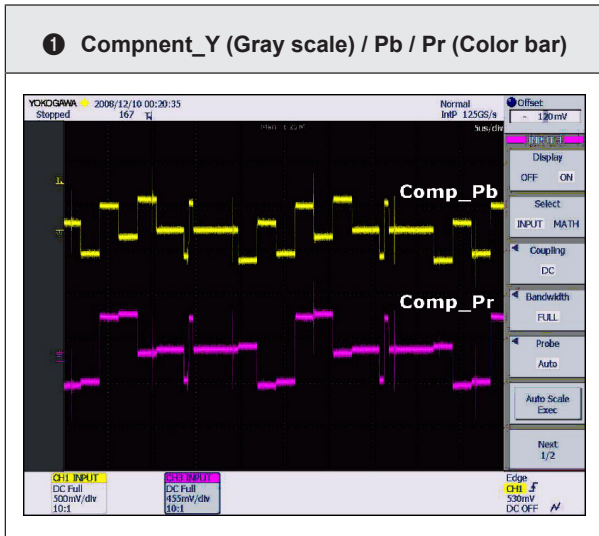
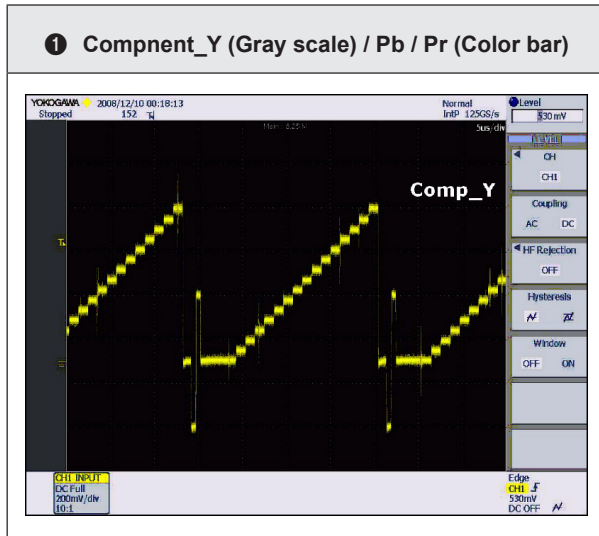

② LVDS output

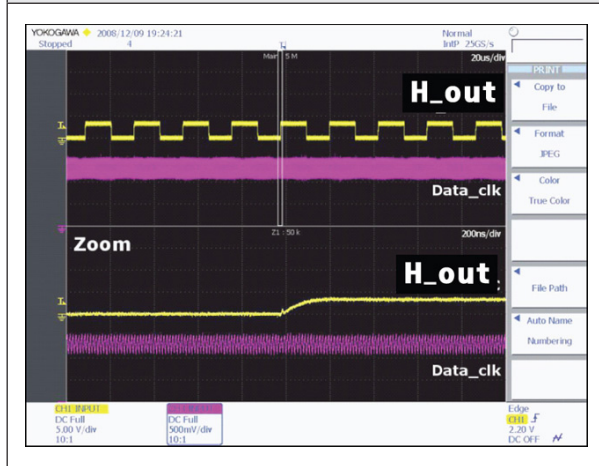

4-2-7. No Sound (1.Speaker 2.Monitor_out 3.Optical)



Note

Refer to the next page to check the location such a CN201 or IC201 SVC Manual mentioned.

Symptom	<ul style="list-style-type: none"> • Video is normal but there is no sound.
Major checkpoints	<ul style="list-style-type: none"> • When the speaker connectors are disconnected or damaged. • When the sound processing part of the Main Board is not functioning. • Speaker defect.
Diagnostics	<pre> graph TD A[Check the source and check the connection of sound cable ? COMP] -- No --> B[Input the sound source properly.] A -- Yes --> C[Check the signal at input of Main Board? AV, COMP L/R : RA503] C -- No --> D[Check CN502. Change the Main Ass'y.] C -- Yes --> E[Check the DATA between the Audio IC's ? - Pin #15 of IC301 : B clk - Pin #20 of IC301 : LR clk - Pin #23, #24 of IC301 : I2C_SDA/ SCL] E -- No --> F[Check IC301. Change the Main Ass'y.] E -- Yes --> G[1. Check the Speaker sound data at ? - CN302 2. Check the Monitor out sound data at ? - CN303_IBR 3. Does the SODIF OUT sound data appear at ? - OP301] G -- No --> H[Change the Main Ass'y.] G -- Yes --> I[Replace speaker ?] I -- No --> J[Please, Contact Tech support.] </pre>
Caution	<p>Make sure to disconnect the power before working on the IP Board.</p>

■ Location of Parts

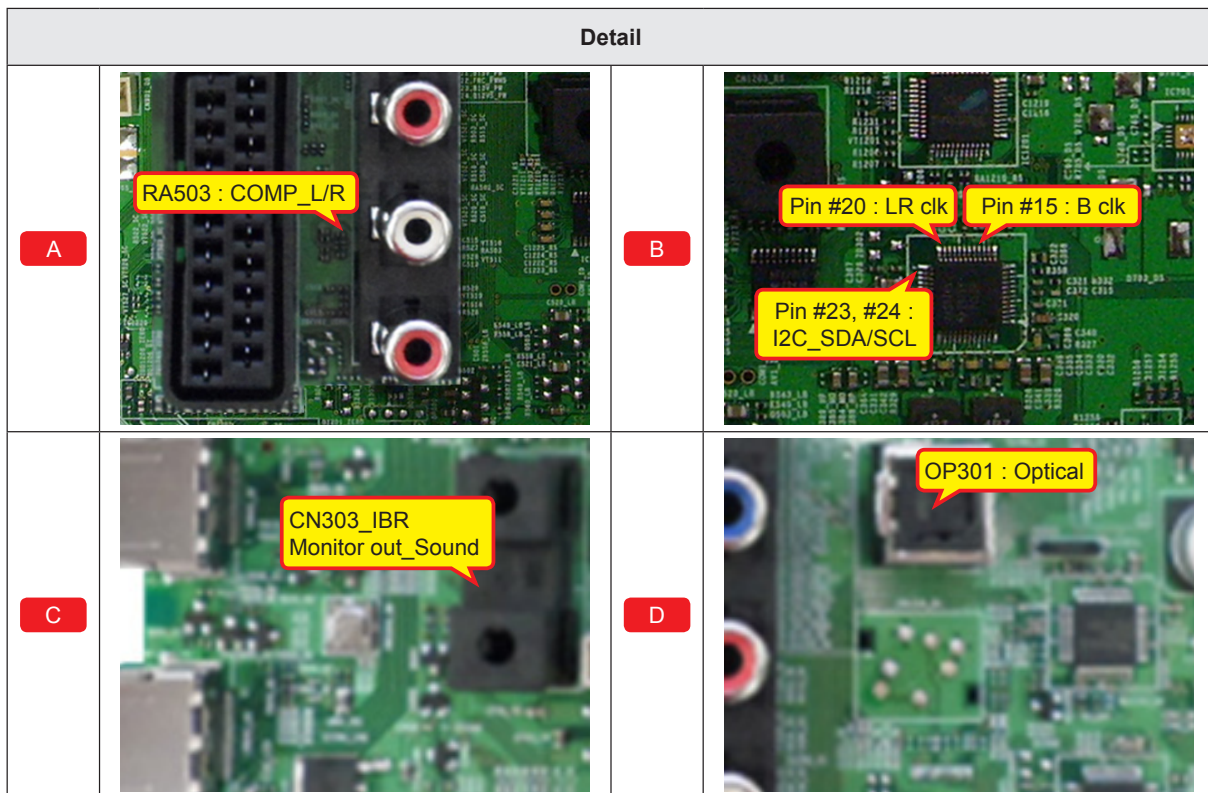
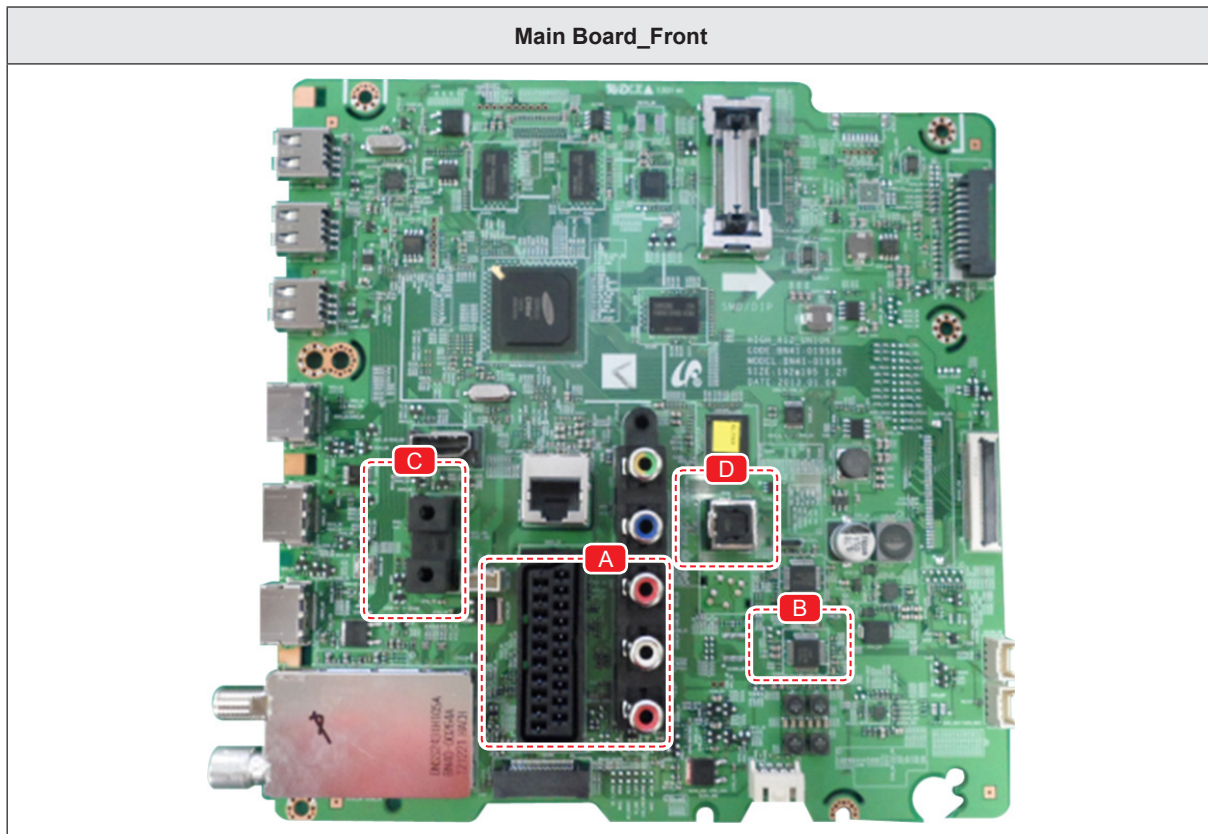

■ Location of Parts

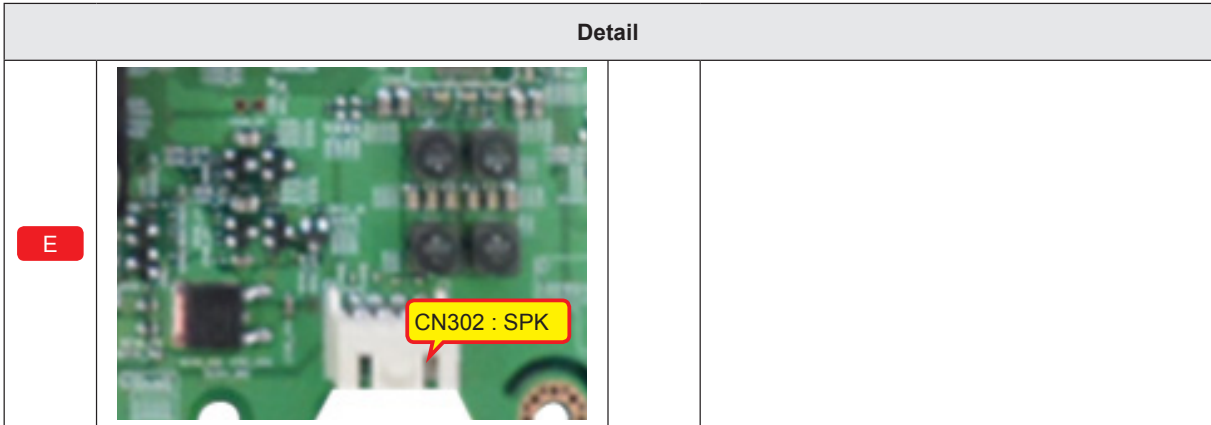
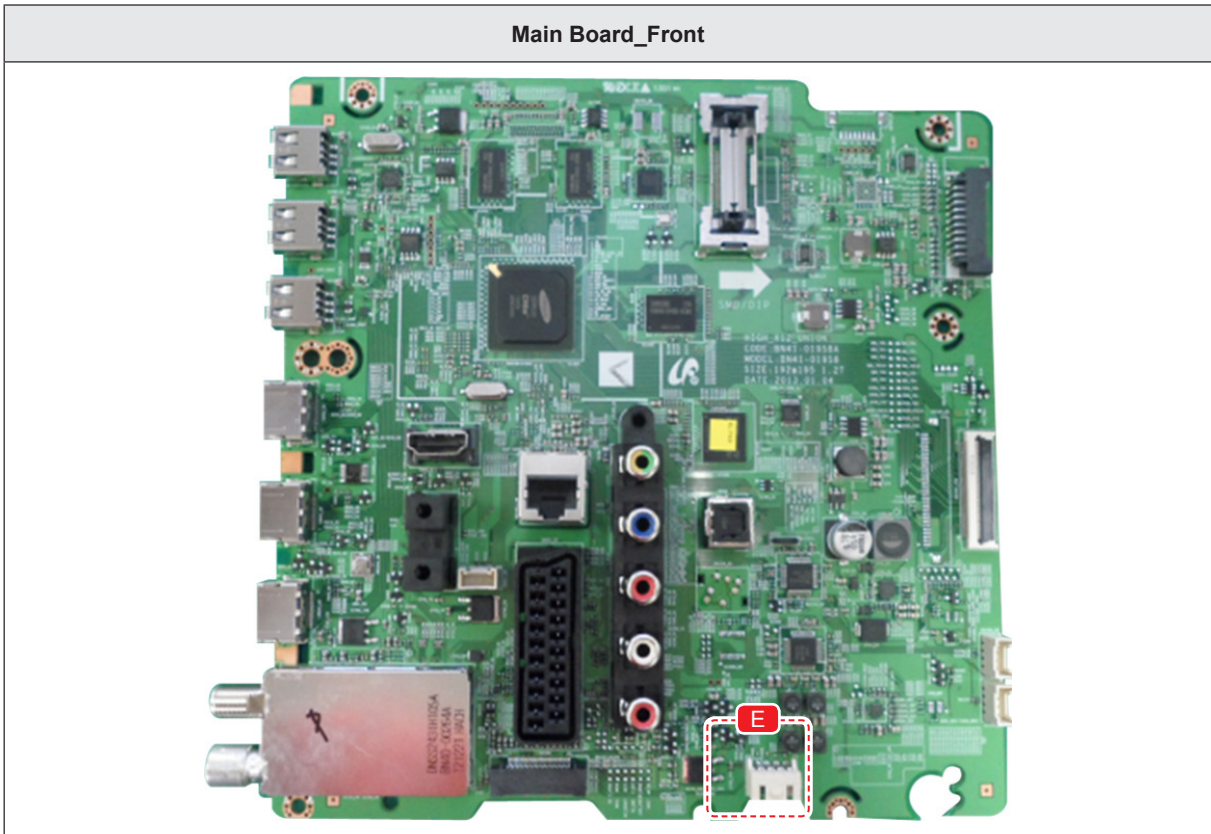

■ Waveforms

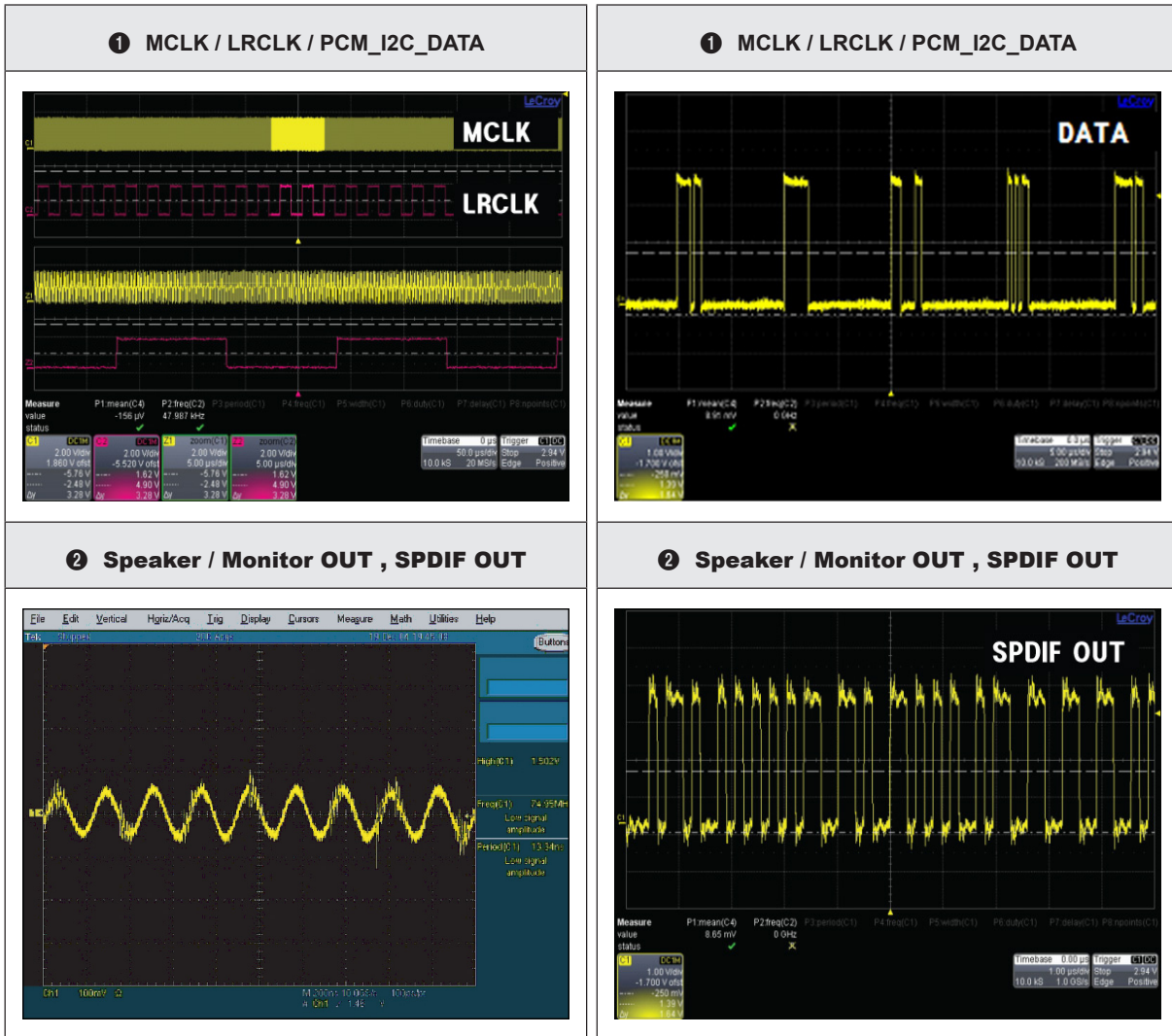

4-3. Factory Mode Adjustments

4-3-1. Detail Factory Option



NOTE

If you replace the main board with new one, please change the factory option as well.
The options you must change are "Type".

■ UE**F6320AWXXH

Inches		40"	46"	55"
PANEL	Vendor	1) SDC 2) SDC	SDC	SDC
	Code	1) BN95-00889A 2) BN95-01110A	BN95-00893A	BN95-01186A
	Spec.	1) CY-HF400CSLV1H/V 2) CY-HF400CSLV2V	CY-HF460CSLV1H/V	CY-HF550CSLV3V
SMPS BOARD	Vendor	HANSOE	HANSOE	SEM
	Code	BN44-00622B	BN44-00623B	BN44-00625C
	Spec.	L42X1Q_DHS	L46X1Q_DHS	L55X1QV_DSM
MAIN BOARD	Chassis Ass'y	BN91-11310R	BN91-11310Q	BN91-11968A
	PBA Ass'y	BN94-06722R	BN94-06722Q	BN94-07162A
Byte	Item			
0	Factory Reset	-	-	-
1	Type	1) 40A1AF0S 2) 40A1AF6V	46A1AF0S	55A1AF1S
2	Local set	EU	EU	EU
3	SW Model	F6320	F6320	F6320
4	BOM Model	6320	6320	6320
5	Tuner	AUTO	AUTO	AUTO
6	Ch table	NONE	NONE	NONE

4-3-2. Entering Factory Mode

To enter 'Service Mode' Press the remote -control keys in this sequence :

- If you do not have Factory remote control



- If you have Factory remote control



- Buttons operations within Service Mode

Menu	Full Menu Display / Move to Parent Menu
Direction Keys ▲/▼	Item Selection by Moving the Cursor
Direction Keys ◀/▶	Data Increase / Decrease for the Selected Item
Source	Cycles through the active input source that are connected to the unit

HOW to enter the Advanced menu (Picture)

❶ Cursor move to 'Advanced'. → ❷ Push the '0' button 4 times. → ❸ You can see the 'Picture' menu.

- If you don't have Factory remote control, can't control some menus. (Expert, Advanced menu)

Option	T-MST12DEUC-xxxx
Control	T-MST12DEUS-xxxx
Debug	BT Version : xxxx
SVC	E-Manual : xxxx
ADC/WB	Camera Version : xxxx
Advanced	Blaster-version : ----
	EDID SUCCESS
	CALIB : AV/COMP/PC/HDMI/
	Option : xxxx,UE,6400,NONE
	USB RS232C : OFF
	SDAL-X12-MAIN-xxxx-xxxx
	RFS : "X12 0071" KER/201x-xx-xx
	KERNEL : 8.0837, D / Onboot :xxxx.x
	Backend IC[x], Data Ver : xxxx
	TCON Version : xxxx
	DTP-DTVTD-xxxx
	Model : UE46F6400
	Wired MAC SUCCESS
	Wireless MAC SUCCESS
	DRM : Crt O, Nf O, Wv O, Hc O, Dc O, Mx O, MI O
	Factory Data Ver : 97
	EERC Version : 51
	DTP-BP-HAL-3183
	DTP-AP-CNC-3151
	DTP-AP-MM-3145
	DTP-AP-WP-3148
	DTP-BP-MW-3156
	DTP-BP-APP-3156
	POP-FLA-13-TEMP
	Date of purchase : mm/dd/yyyy

4-3-3. Factory Data

■ Option

Factory Menu Name	Data	Range
Factory Reset	-	
Type	40A1AF0S ; 40A1AF6V 46A1AF0S 55A1AF1S	
Local Set	EU	
SW Model	F6320	
BOM Model	6320	
TUNER	AUTO	
Ch Table	NONE	
MRT Option		
Front Color		
LVDS FORMAT	JEIDA	
Language_Arabic	US	
Region	USA	
PnP Language	ENG_US	
WIFI REGION	S	
OTN Support	ON	
OTA Support	OFF	
TTX	OFF	
China HD	OFF	
NT Conversion	OFF	
Num of DTV	1	
Num of AV	1	
Num of COMP	1	
Num of HDMI	4	
Num of SCART	0	
Num of USB Port	3	
Num of HeadPhone	0	
Num of RVU	1	
Num of Display	2	
Num of IPTV	0	
Num of RUI	0	
Num of PVR RECORD	0	
TOOLS Support	40	
LNA Support	OFF	

Factory Menu Name	Data	Range
24Px4 Support	OFF	
BD Wise Support	ON	
Data Service Support	OFF	
PVR Support	OFF	
CI Support	OFF	
LEDMotionPlus Support	ON	
Natural Mode Support	ON	
Relax Mode Support	OFF	
HDMI/DVI SEL	4	
Select LCD/PDP	LCD	
Wall Mount	OFF	
HV Flip		HV Flip / H Filp / OFF
Light Effect	OFF	
e-Pop Default	1	
CAMERA Support	OFF	
NETWORK Support	3	
EcoSensor Support	ON	
3D Support	ON	
BT Support	ON	
BT ADDRESS		
Engineer Option		
Auto Power	MEMORY	
Type Of PANEL KEY	None	
5 Way Function Key	R BACK	
Contents Bar	OFF	
Cable Modulation	QAM	
Standby led on/off	OFF	
Recognition Support		
IF AGC	0	
D AGC	0	
PH BW	0	
FQ BW	0	
PH RATE	0	
PD EN	0	
PEQ Inx	0	
WF Scale		
WF Type	0	

4. Troubleshooting

Factory Menu Name	Data	Range
Nu of Network Stream	1	
DP V Size	0	
Backend Device	FOX-FT1	
BT_AUDIO_ON_OFF	OFF	
Config_AV_PATH		
ECO Standby	OFF	
Fast Logo Delay	0	
Num of PANEL KEY	6	

■ Control

Factory Menu Name	Data	Range
EDID		
EDID ON/OFF	OFF	
EDID WRITE ALL	...	
EDID WRITE HDMI	...	
EDID Ver	...	
EDID Port		
Sub Option		
RS-232 Jack	UART	Debug/UART
Watchdog	OFF	
Checksum	0x0000	
Fast Boot in Production	OFF	
USB Serial	OFF	
Eeprom Reset		
ECO IC TYPE	NONE	
Info Link Server Type	development	
Info Link Country	None	
TTX Group	-	
Visual Test	-	
MediaPlayDB	-	
OPTION_SWU		
OTN Server Type	operating	
OTN Test Server	OFF	
SWU Reset		
SWU Duration	OFF	
SWU Fail Test	OFF	
OPTION_NUM		

Factory Menu Name	Data	Range
Num of ATV	1	
Num of SVIDEO	0	
Num of PC	0	
Num of DVI	0	
Num of OPTICAL Link	1	
Num of MEDIA	1	
Num of Tuner	1	
Num of ISP	1	
RF Remocon Support	OFF	
CDD mode	-	
DPMS Support	OFF	
Num of IPTV CIP	0	
Num of CI	0	
Num of DECODER	0	
T-CON Device		
BOARD CONTROL	OFF	
HP LINE	LineOut	
RM		
Server Type	Operating	
RTS Mode	OFF	
PSA		
FKP Download1	0	
FKP Download2	0	
LMK threshold	3	
Low threshold	10	
High threshold	15	
CSB	ON	
CLB	ON	
PDP Option		
Pixel Shift Test	OFF	
Logic SW	0	
Panel Temperature	0	
LOGIC Waveform Day	0	
Logic CheckSum	0	
MRT	0	
SAPC Timer		
APC Speed		

4. Troubleshooting

Factory Menu Name	Data	Range
Hotel Option		
Hospitality Mode	OFF	
Power On	...	
Menu OSD	...	
Operation	...	
Music Mode	...	
External Source	...	
Eco Solution	...	
Cloning	...	
Shop Option		
Shop Mode	OFF	
Exhibition Mode	OFF	
3D Cube	OFF	
Asia Option		
Unbalance	OFF	
AF Level adjust	3	
TX Power Level	0	
Mono Last Memory	OFF	
H Shaking	OFF	
SOUND		
Carrier_Mute	OFF	
High Devi	OFF	
Speaker Delay Normal	0x6Eh	
SPDIF PCM Gain	-9dB	
FM M Prescale	0x30h	
FM Prescale	0x00h	
AM Prescale	0x32h	
NICAM Prescale	0x48h	
BTSC Mono Prescale	0x19h	
BTSC stereo Prescale	0x2Fh	
BTSC SAP Prescale	0x2Bh	
A2Ident High THID	31	
A2Ident Low THID	0	
Pilot Level High Thld	0x28h	
Pilot Level Low Thld	0x10h	
Carrier2 Amp High THID	4	
Carrier2 Amp Low THID	3	

Factory Menu Name	Data	Range
Carrier2 SNR High THR	16	
Carrier2 SNR Low THR	80	
Sig Error On	35	
Sig Error Off	41	
Amp Model	TAS5745	
Amp Volume	0xcbh	
Amp Scale	0x35h	
Amp Check Sum	0x000821B2	
Woofer Type	0	
Woofer Scale	0	
Woofer Check Sum	0x8ah	
Woofer Local EQ Checksum	0	
Speaker EQ	ON	
PEQ Test	Ready	
Local Speaker EQ	0	
Local EQ Checksum	0	
Speaker cut-off Ferq	4	
Audio-IP Test		
SRS Tuning Parm	0	
TruBass-Checksum	0	
Mic Scale	0	
Subwoofer Support	0	
India Sound	OFF	
AudioDock BT delay	50	
Wall Filter Type	0	
Wiselink Delay Menu	90	

■ Debug

Factory Menu Name	Data	Range
Spread Spectrum		
LVDS Spread	ON	
DDR Spread	1.0% Spectrum	
Period	30K	
Amplitude	1	
HD SSC ON/Off	ON	
HD SSC Value	1	
LVDS SSC ON/Off	ON	

4. Troubleshooting

Factory Menu Name	Data	Range
LVDS SSC Value	0	
DDR SSC ON/Off	ON	
DDR SSC Value	1	
FRC LVDS SSC ON/OFF	ON	
FRC LVDS SSC MRR	10	
FRC LVDS SSC MFR	1	
FRC LVDS SSC Period	1	
FRC LVDS SSC Modulation	1	
FRC DDR SSC ON/OFF	ON	
FRC DDR SSC MRR	15	
FRC DDR SSC MFR	1	
FRC DDR SSC Period	1	
FRC DDR SSC Modulation	1	
DDR Margin		
A CTRL_OFFSET_0_3	0x0	
A CTRL_OFFSET_D	0x0	
B CTRL_OFFSET_0_3	0x0	
B CTRL_OFFSET_D	0x0	
ND ADJ Support	OFF	
MICOM POWER OFF	OFF	
RF Mute Time	6ms	
CI+1.3	OFF	
FRC		
FRC FDISPLAY ON/OFF	0	
3D FDISPLAY ON/OFF	OFF	
PC Mode ON/OFF	OFF	
Tuner Margin	10	
MPEG Margin	1000	
H.264 Margin	8	
CAM Wait Time		
TS Clock deldy	0	
TCON_TEMP READ	0	
TEMP LAST	60	
DCC VERSION	0x0	
DCC CHK SEL	0	
DCC CHECK LOCAL	0x0	
DCC CHECK TOTAL	0x0	

Factory Menu Name	Data	Range
MultACC Checksum	0	
IIC Bus stop	OFF	
Tuner Status		
DVB		
SNR		
BER		
Signal Strength		
Bandwidth		
Frequency		
LNA Status		
FFT		
Modulation		
Code Rate		
GI		
Hier Modulation		
Frequency offset		
Timing offset		
AGC		
UCB		
PLL Type		
DEMOD Type		
TPS Lock		
RS Lock		
SSI		
SQI		
Firmware Version		
ISDB-T		
FFT Size_1		
Guard Interval_1		
Freq. Offset_1		
SNR_1		
IF AGC_1		
TMCC Lock_1		
TS Packer_1		
Master Lock_1		
A_Modulation_1		
A_Code Rate_1		

4. Troubleshooting

Factory Menu Name	Data	Range
A_Timer InterLeave_1		
A_Segments Num_1		
A_BER_1		
B_Modulation_1		
B_Code Rate_1		
B_Timer InterLeave_1		
B_Segments Num_1		
B_BER_1		
C_Modulation_1		
C_Code Rate_1		
C_Timer InterLeave_1		
C_Segments Num_1		
C_BER_1		

■ SVC

Factory Menu Name	Data	Range
Test Pattern		
Pattern Sel	OFF	
Logic Pattern Sel	...	
Logic Level Sel	...	
FRC Pre Test Pattern	0	
FRC Post Test Pattern	0	
FRC3D Fdisplay	OFF	
FRC3D PC Mode	OFF	
SOC TCON Test Pattern	0	
SOC TCON Pattern Level	255	
SOC TCON FRC Pattern	0	
HDMI WB Pattern	OFF	
HDMI Pattern Sel	0	
Parma Pre Test Pattern	0	
Parma Post Test Pattern	0	
Panel Display Time	0Hr	
SVC Info	0	
Delete S/N	0	
Upgrade		
T-CON Usb Download	Failute	
T-CON CheckSum	Error	

Factory Menu Name	Data	Range
Logic Usb D/L	...	
SUBMICOM UPGRADE	Failute	
BT UPGRADE		
BT FREPAIRING	ON	
Function Upgrade	Failute	
FRC3D FW Upgrade		
Camera Upgrade		
Mic Upgrade		
CPLD USB Download		
JP MICOM UPGRADE	Failute	
DP MICOM UPGRADE	Failute	
Jump Upgrade	Failute	
Smart Hub Reset	0	
ER Count		
WD Count	0	
AR Count	0	
WIFI ER Count	0	
BT ER Count	0	
HDMI Err Cnt	0	
Camera ER Count	0	
LOG(View Log)		
Select Log Type	NVRAM	
Log View	0	
Delete Log		
Debug Log Down		
Emergency Log Copy		
Self Diagnosis		
Loop Back		
LAN Test		
AV Audio Test		
DVIN Audio Test		
CVBS Test		
COMP Test		
USB HUB Test		
HDMI Test		
SCART Audio Test		
SCART CVBS Test		

4. Troubleshooting

Factory Menu Name	Data	Range
SCART RGB Test		
CPU		
DDR		
FLASH		
EEPROM		
Sound AMP		
HDMI Switch IC		
USB HUB IC		
WIFI		
LVDS		
T-CON/FRC		
PCB Test		
MOIP		
App Self Test		
Device self Test		
Voltage		
EcoSensor		
BT		
EXT Sound Inspection		
Woofers Sound Inspection	NONE	
ATV CH Inspection		
DTV CH Inspection		
Satellite CH Inspection		
IPERF	Stopped	
OPTION HDMI		
Expert		
DVB CI		
CAL Data Backup	...	
CAL Data Restore	...	

■ ADC/WB

Factory Menu Name	Data	Range
ADC		
AV Calibration	Success	
Comp Calibraion	Success	
PC Calibration	Success	
HDMI Calibration	Success	

Factory Menu Name	Data	Range
ADC Result		
1st_Y_GH	258	
1st_Y_GL	128	
1st_Cb_BH	...	
1st_Cb_BL	...	
1st_Cr_RH	...	
1st_Cr_RL	...	
2nd_R_L	132	
2nd_G_L	132	
2nd_B_L	132	
2nd_R_H	70	
2nd_G_H	70	
2nd_B_H	70	
White Balance		
R-Offset	128	
G-Offset	128	
B-Offset	128	
R-Gain	128	
G-Gain	128	
B-Gain	128	
WB_W2_R_Offset	128	
WB_W2_B_Offset	128	
WB_W2_R_Gain	164	
WB_W2_B_Gain	63	
WB_N_R_Offset	128	
WB_N_B_Offset	128	
WB_N_R_Gain	151	
WB_N_B_Gain	108	
MGA		
MGA On/Off	OFF	
R1_Gain	...	
B1_Gain	...	
G1_Gain	...	
R2_Gain	...	
B2_Gain	...	
G2_Gain	...	
R3_Gain	...	

4. Troubleshooting

Factory Menu Name	Data	Range
B3_Gain	...	
G3_Gain	...	
R4_Gain	...	
B4_Gain	...	
G4_Gain	...	
R5_Gain	...	
B5_Gain	...	
G5_Gain	...	
R6_Gain	...	
B6_Gain	...	
G6_Gain	...	
R7_Gain	...	
B7_Gain	...	
G7_Gain	...	
R8_Gain	...	
B8_Gain	...	
G8_Gain	...	
R9_Gain	...	
B9_Gain	...	
G9_Gain	...	
R10_Gain	...	
B10_Gain	...	
G10_Gain	...	

4-4. White Balance

4-4-1. Calibration

1. Into the Factory Mode.
2. Select **ADC/WB** menu.
3. Select **ADC** menu.

Option	AV Calibration
Control	Comp Calibration
Debug	HDMI Calibration
SVC	
ADC/WB	
Advanced	

4-4-2. Service Adjustment

You must perform Calibration in the Lattice Pattern before adjusting the White Balance.

■ Color Calibration

- Adjust Specification

Source	Setting Mode	Pattern	Use Equipment
HDMI	1280 x 720@60 Hz	Pattern #24 (Chess Pattern)	CA210 & Master MSPG925 Generator

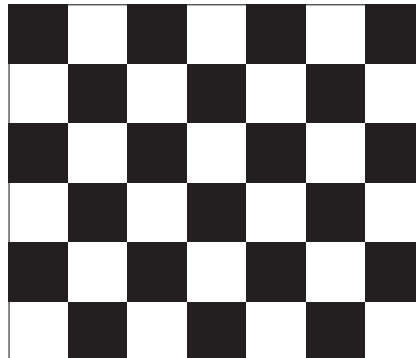

(Chess Pattern)

- Use other equipment only after comparing the result with that of the Master equipment.

Input mode	Calibration	Pattern
CVBS IN (Model_#1)	Perform in NTSC B&W Pattern #24	Lattice
Component IN (Model_#6)	Perform in 720p B&W Pattern #24	Lattice
HDMI IN	Perform in 720p B&W Pattern #24	Lattice

Method of Color Calibration (AV)

1. Apply the NTSC Lattice (N0. 3) pattern signal to the AV IN 1 port.
2. Press the Source key to switch to “AV1” mode.
3. Enter Service mode.
4. Select the “ADC” menu.
5. Select the “AV Calibration” menu.
6. In “AV Calibration Off” status, press the “▶” key to perform Calibration.
7. When Calibration is complete, it returns to the high-level menu.
8. You can see the change of the “AV Calibration” status from Failure to Success.

Method of Color Calibration (Component)

1. Apply the 720p Lattice (N0. 6) pattern signal to the Component IN 1 port.
2. Press the Source key to switch to “Component1” mode.
3. Enter Service mode.
4. Select the “ADC” menu.
5. Select the “Comp Calibration” menu.
6. In “Comp Calibration Off” status, press the “▶” key to perform Calibration.
7. When Calibration is complete, it returns to the high-level menu.
8. You can see the change of the “Comp Calibration” status from Failure to Success.

Method of Color Calibration (HDMI)

1. Apply the 720p Lattice (N0. 6) pattern signal to the HDMI1/DVI IN port.
2. Press the Source key to switch to “HDMI1” mode.
3. Enter Service mode.
4. Select the “ADC” menu.
5. Select the “HDMI Calibration” menu.
6. In “HDMI Calibration Off” status, press the “▶” key to perform Calibration.
7. When Calibration is complete, it returns to the high-level menu.
8. You can see the change of the “HDMI Calibration” status from Failure to Success.

4-4-3. Adjustment

9. Into the Factory Mode.
10. Select **ADC/WB** menu.
11. Select **White Balance** menu.

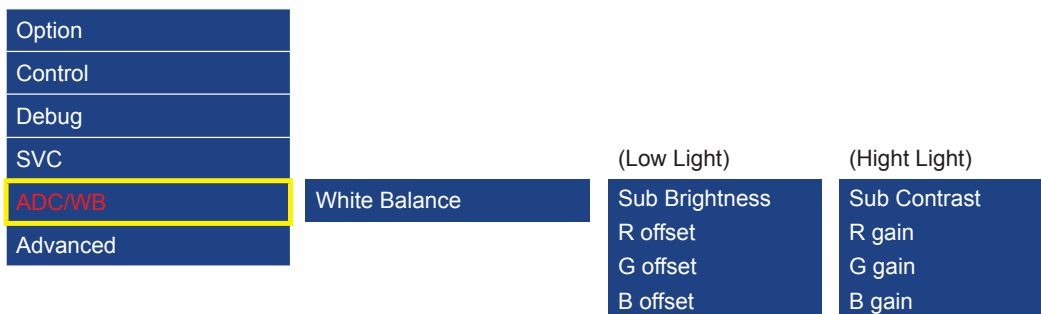

4-5. RS-232C

- **RS232C Control**
 - Port : COM#(Serial)
 - Bit rate : 115200
 - Data Bit : 8 bit
 - Parity : None
 - Stop Bits : 1
 - Flow Control : None

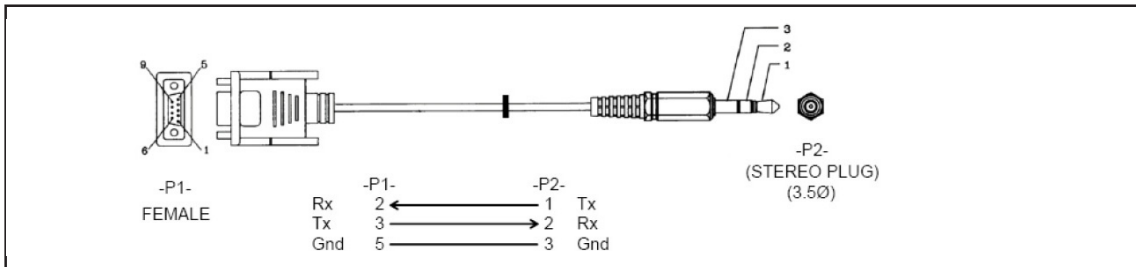

- Description of RS232C

Pin#	Name	Full Name	Pin#	Name	Full Name	Pin#	Name	Full Name
1	CD	Carrier Detect	4	DTR	Data Terminal Ready	7	RTS	Request To Send
2	RxD	Received Data	5	GND	Signal Ground	8	CTS	Clear To Send
3	TxD	Transmitted Data	6	DSR	Data Set Ready	9	RI	Ring Indicator

4-6. AV Control Tab

Control Item				Cmd1	Cmd2	Cmd3	Value	
General	Power	Power		0x00	0x00	0x00	0x00	
		Off					0x01	
		On					0x02	
	Volume	Direct		0x01	0x00	0x00	(0~100)	
		Up				0x01	0x00	
		Down				0x02	0x00	
	Mute			0x02	0x00	0x00	0x00	
		Ch.	Direct		0x04	-		
			Continuous	Up		0x03	0x00	0x01
		Down					0x02	0x00

Control Item				Cmd1	Cmd2	Cmd3	Value	
Input	Source List	TV	TV	0x0a	0x00	0x00	0x00	
			AV			0x01	0x00	
		AV	AV1				0x01	0x00
			AV2					0x01
			AV3					0x02
		S-Video	S-Video1				0x02	0x00
			S-Video2					0x01
			S-Video3					0x02
		Component	Component1				0x03	0x00
			Component2					0x01
			Component3					0x02
		PC	PC1				0x04	0x00
			PC2					0x01
			PC3					0x02
		HDMI	HDMI1				0x05	0x00
			HDMI2					0x01
			HDMI3					0x02
			HDMI4					0x03
		DVI	DVI1				0x06	0x00
			DVI2					0x01
DVI3						0x02		

Control Item				Cmd1	Cmd2	Cmd3	Value
PICTURE	Mode	Dynamic(Entertain)		0x0b	0x00	0x00	0x00
		Standard					0x01
		Movie					0x02
		Natural					0x03

		Control Item		Cmd1	Cmd2	Cmd3	Value	
PICTURE	Mode	CAL-NIGHT					0x04	
		CAL-DAY					0x05	
		BD Wise					0x06	
		Relax					0x07	New function of 12" (only PDP TV)
	BackLight (CellLight)		0~20		0x01	0x00	(0~20)	
	Contrast		0~100		0x02	0x00	(0~100)	
	Brightness		0~100		0x03	0x00	(0~100)	
	Sharpness		0~100		0x04	0x00	(0~100)	
	Color		0~10		0x05	0x00	(0~100)	
	Tint	G/R			0x06	0x00	(0~100)	
	Advanced Settings	Black Tone	Off			0x07	0x00	0x00
			Dark					0x01
			Darker					0x02
			Darkest					0x03
		Dynamic Contrast	Off				0x01	0x00
			Low					0x01
			Medium					0x02
			High					0x03
		Shadow Detail	-2 ~ 2				0x02	(-2~2)
		Gamma	-3 ~ 3				0x03	(-3~3)
		RGB Only Mode	Off				0x05	0x00
			Red					0x01
			Green					0x02
			Blue					0x03
		Color Space	Auto				0x06	0x00
			Native					0x01
			Custom					0x02
		White Balance	R-Offset(LCD)				0x07	(0~50)
		White Balance	G-Offset(LCD)				0x08	(0~50)
		White Balance	B-Offset(LCD)				0x09	(0~50)
	White Balance	R-Gain(LCD)				0x0a	(0~50)	
	White Balance	G-Gain(LCD)				0x0b	(0~50)	
White Balance	B-Gain(LCD)				0x0c	(0~50)		
White Balance	Reset(LCD)				0x0d	0x00		
Flesh Tone	-15 ~ 15				0x0e	(-15~15)		
Edge Enhancement	Off				0x0f	0x00		

4. Troubleshooting

Control Item		Cmd1	Cmd2	Cmd3	Value		
PICTURE		On			0x01		
		xvYCC	Off		0x10	0x00	
			On			0x01	
		Motion Lighting	Off		0x11	0x00	
			On			0x01	
		LED Motion Plus	Off	0x0a	0x07	0x00	
			On(Normal)			0x01	
			Cinema			0x02	
			Ticker			0x03	
		Picture Option	Color Tone	Cool	0x0a	0x00	0x00
	Standard					0x01	Change Normal → Standard mode
	Warm1					0x02	
	Warm2					0x03	
	Digital Noise Filter		Off		0x02	0x00	
			Low			0x01	
			Medium			0x02	
			High			0x03	
			Auto			0x04	
			Auto Visualization			0x05	
	MPEG Noise Filter		Off		0x03	0x00	
			Low			0x01	
			Medium			0x02	
			High			0x03	
			Auto			0x04	
	HDMI Black Level		Normal		0x04	0x00	
			Low			0x01	
	Film Mode		Off		0x05	0x00	
			Auto1			0x01	
			Auto2			0x02	
			Cinema Smooth			0x03	New function of 12" (only PDP TV)
	Auto Motion Plus		Off		0x06	0x00	
			Clear			0x01	
Standard					0x02		
Smooth					0x03		
Custom					0x04		

Control Item				Cmd1	Cmd2	Cmd3	Value	
PICTURE			Demo				0x05	
	Screen Adjustment	Picture Size	16:9	0x0b	0x0a	0x01	0x00	
			Zoom1				0x01	
			Zoom2				0x02	
			Wide Fit				0x03	
			4:3				0x04	
			Screen Fit				0x05	
			Smart View I				0x06	
			Smart View II				0x07	
			Auto Wide				0x08	New function of 12" (only DVB TV)
			Wide Zoom				0x09	
			Zoom				0x0a	
			Reset Picture	Reset Picture		0x0b	0x0b	0x00
	3D	3D Mode	Off	0x0b	0x0c	0x00	0x00	
			2D ↔ 3D				0x01	
			Side By Side				0x02	
			Top Bottom				0x03	
			Line By Line				0x04	
			Vertical Line				0x05	
			Checker BD				0x06	
			Frame Sequence				0x07	
			3D ↔ 2D	Off			0x01	0x00
				On				0x01
		3D View Point				0x02	(-5~5)	
		Depth				0x03	(1~10)	
		3D Auto View	Off			0x05	0x00	
			Message Notice				0x01	
			On				0x02	
	Control Item				Cmd1	Cmd2	Cmd3	Value
	Sound	Sound Mode	Standard		0x0c	0x00	0x00	0x00
			Music					0x01
			Movie					0x02
Clear Voice							0x03	
Amplify							0x04	

4. Troubleshooting

Control Item		Cmd1	Cmd2	Cmd3	Value	
Sound	Equalizer	Balance		0x01	0x00	(0~20)
		100hz			0x01	(0~20)
		300hz			0x02	(0~20)
		1khz			0x03	(0~20)
		3khz			0x04	(0~20)
		10khz			0x05	(0~20)
		Reset			0x06	0x00
	SRS TruSurround HD (echo)	Off		0x02	0x00	0x00
	Virtual Surround (echo)	On				0x01
	SRS TruDialog (echo)	Off		0x03	0x00	0x00
	Dialog Clarify (X9)	On				0x01
	Preferred Language	English		0x04	0x00	0x00
		Spanish				0x01
		French				0x02
		Korean				0x03
		Japanese				0x04
	Multi-Track Sound	Mono		0x05	0x00	0x00
		Stereo				0x01
		SAP				0x02
	Auto Volume	Off		0x06	0x00	0x00
		ON				0x01
		Night				0x02
	Speaker Select	TV Speaker		0x07	0x00	0x00
		External Speaker				0x01
	Sound Select	Main		0x08	0x00	0x00
		Sub				0x01
	Sound Reset	Sound Reset		0x09	0x00	0x00
	3D Audio	Off		0x0a	0x00	0x00
		Low				0x01
		Medium				0x02
		High				0x03

New function of 12"

Control Item		Cmd1	Cmd2	Cmd3	Value
KEY	Key Generation	0x0d	0x00	0x00	refer to table
OSD	Show/Hide Control	0x0e	0x00	0x00	0x00
	Hide				0x01
Get Status	Power (On/Off)	0xf0	0x00	0x00	0x00
	Volume(0~100)	0xf0	0x01	0x00	0x00
	Mute (On/Off)	0xf0	0x02	0x00	0x00
	Channel Number	0xf0	0x03	0x00	0x00
	Source (TV/AV/.../HDMI/...)	0xf0	0x04	0x00	0x00
	Picture Size	0xf0	0x05	0x00	0x00
	3D (On/Off)	0xf0	0x06	0x00	0x00
	Picture Mode	0xf0	0x07	0x00	0x00
Sound Mode	0xf0	0x08	0x00	0x00	

New function of 12"

Key value	Value
Up	96 (0x60)
Down	97 (0x61)
Left	101 (0x65)
Right	98 (0x62)
Menu	26 (0x1A)
Internet	147 (0x93)
Enter(OK)	104 (0x68)
EXIT	45 (0x2D)

4-7. Software Upgrade

Software Upgrade can be performed by downloading the latest firmware from samsung.com to a USB memory device.

- Current Version - The software already installed in the TV.

Software is represented as 'Year/Month/Day_Version'.

4-7-1. How to Check the Software Version

■ Use the Main Menu

1. Click the "MENU" key in remote controller.
2. Select "Support" menu.
3. Locate the menu cursor "Software Upgrade" menu.
4. Click the "INFO" key.
 - Check the Main SW and Micom version.

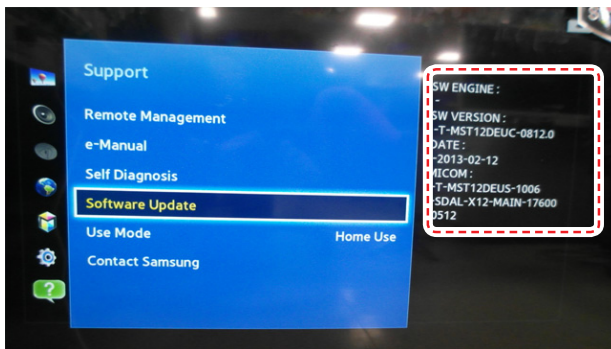

■ Use the Factory Mode

Option
Control
Debug
SVC
ADC/WB
Advanced

```

T-MST12DEUC-xxxx
T-MST12DEUS-xxxx
BT Version : xxxx
E-Manual : xxxx
Camera Version : xxxx
Blaster-version : ----

EDID SUCCESS
CALIB : AV/COMP/PC/HDMI/
Option : xxxx,UE,6400,NONE
USB RS232C : OFF

SDAL-X12-MAIN-xxxx-xxxx
RFS : "X12 0071" KER/201x-xx-xx
KERNEL : 8.0837, D / Onboot :xxxx.x
Backend IC[x], Data Ver : xxxx
TCON Version : xxxx
DTP-DTVTD-xxxx
    
```

4-7-2. How to Upgrade Software

1. Insert a USB drive containing the firmware upgrade downloaded from samsung.com into the TV.



NOTE

Please be careful not to disconnect the power or remove the USB drive while upgrades are being applied.

2. The TV will turn off and turn on automatically after completing the firmware upgrade.
3. Please check the firmware version after the upgrades are complete.
 - the new version will have a higher number than the older version.



NOTE

- When software is upgraded, video and audio settings you have made will return to their default (factory) settings.
- We recommend you write down your settings before beginning firmware update.

4. After update is completed, restore your previous settings.

■ Main Software Upgrade

1

Store the sw program named "**T-MST12DEUC**" in USB memory stick.

2

Click the "**MENU**" key in Remote Controller.

3

Select "**Support - Software Update - Update Now**" menu.

4

- Click the "**ENTER**" key.
- Wait for upgrade complete.
 - Check the Software Version.

■ Sub Software Upgrade

USB Download

1. After Main Software upgrade, Enter the Factory menu by below method.

- Factory Remocon
 - Click the Remocon button continuedly. (Info key+ Factory key)



- Nomal Remocon
 - ① Turn off the TV. → ② Click the Remocon button continuedly.

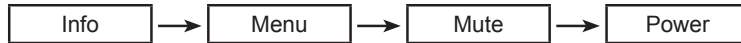

2. Select the "SVC".

Option
Control
SVC
Expert
ADC/WB
Advanced

3. Select the "SUBMICOM UPGRADE".

Test pattern		DCC CHK SEL	0
Panel Display Time	1Hr	DCC CHECK LOCAL	0x0
Tuner Status		DCC CHECK TOTAL	
T-CON Usb Download	Failure	Fuction Upgrade	off
T-CON CheckSum	Error	Smart Hub Reset	off
Tuner Margin	10	WIFI ER COUNT	0
TS Clock delay	0	BT ER COUNT	0
SUBMICOM UPGRADE	off	Debug Log Down	
BT ADDRESS	0000	MultACC Checksum	Error
BT UPGRADE		SVC Info	
BT FREEPAIRING	ON	TS Clock delay TC	0
SVC Reset		TS Clock delay S	0
TCON_TEMP READ	0.00	CAL Data Backup
TEMP LAST	60.00	CAL Data Restore
DCC VERSION	0x0		

4. Click the "→" remocon key.

SUBMICOM UPGRADE	Wait
-------------------------	------

- Wait for upgrade complete.
- Check the Software version.

5. Wiring Diagram

5-1. Wiring Diagram

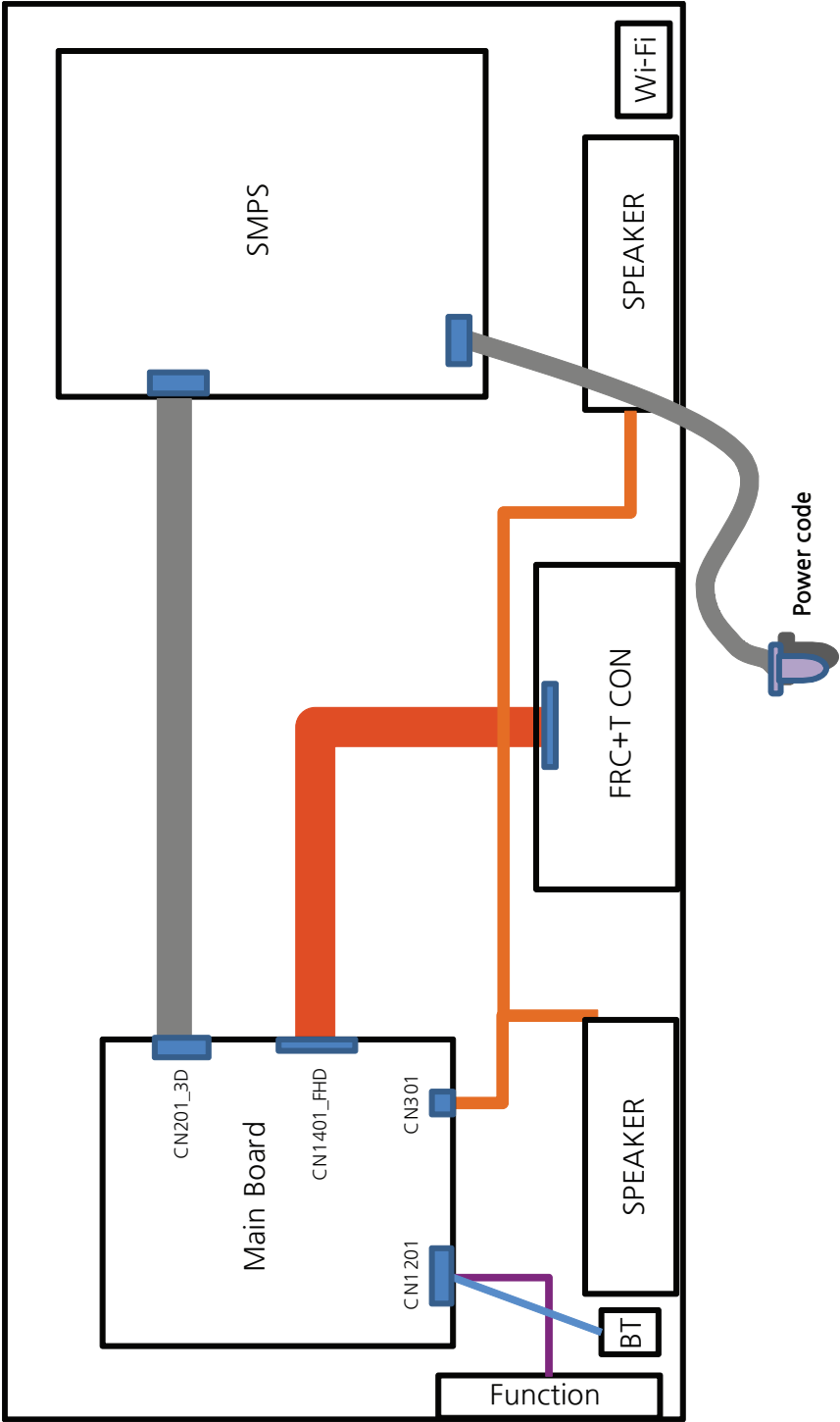

5-2. Connector

CN1401_FHD			
1	NC	27	EVEN_TX0-
2	GND	28	GND
3	FRC_SDA	29	ODD_TX4+
4	FRC_PWM1	30	ODD_TX4-
5	FRC_SCL	31	ODD_TX3+
6	FRC_PWM3	32	ODD_TX3-
7	FRC_PWM2	33	GND
8	TCON_SDA	34	ODD_TXCLK+
9	PANEL_I2C_EN	35	ODD_TXCLK-
10	BT_SYNC	36	GND
11	UPDATE_CHK	37	ODD_TX2+
12	TCON_SCL	38	ODD_TX2-
13	GND	39	ODD_TX1+
14	EVEN_TX4+	40	ODD_TX1-
15	EVEN_TX4-	41	ODD_TX0+
16	EVEN_TX3+	42	ODD_TX0-
17	EVEN_TX3-	43	GND
18	GND	44	GND
19	EVEN_TXCLK-	45	GND
20	EVEN_TXCLK+	46	FRC_PWM4
21	GND	47	PANEL_13V_PW
22	EVEN_TX2+	48	PANEL_13V_PW
23	EVEN_TX2-	49	PANEL_13V_PW
24	EVEN_TX1+	50	PANEL_13V_PW
25	EVEN_TX1-	51	PANEL_13V_PW
26	EVEN_TX0+		

CN601(to HDMI1)			
1	HDMI1_RX2+	11	GND
2	GND	12	HDMI1_RXCLK-
3	HDMI1_RX2-	13	CEC
4	HDMI1_RX1+	14	NC
5	GND	15	HDMI1_SCL_DDC
6	HDMI1_RX1-	16	HDMI1_SDA_DDC
7	HDMI1_RX0+	17	GND
8	GND	18	HDMI1_5V
9	HDMI1_RX0-	19	HDMI1_HOT_PLUG
10	HDMI1_RXCLK+		

CN602(to HDMI2)			
1	HDMI2_RX2+	11	GND
2	GND	12	HDMI2_RXCLK-
3	HDMI2_RX2-	13	CEC
4	HDMI2_RX1+	14	ARC2_SIGLE
5	GND	15	HDMI2_SCL_DDC
6	HDMI2_RX1-	16	HDMI2_SDA_DDC
7	HDMI2_RX0+	17	GND
8	GND	18	HDMI2_5V
9	HDMI2_RX0-	19	HDMI2_HOT_PLUG
10	HDMI2_RXCLK+		

CN603(to HDMI3)			
1	HDMI3_RX2+	11	GND
2	GND	12	HDMI3_RXCLK-
3	HDMI3_RX2-	13	CEC
4	HDMI3_RX1+	14	NC
5	GND	15	HDMI3_SCL_DDC
6	HDMI3_RX1-	16	HDMI3_SDA_DDC
7	HDMI3_RX0+	17	GND
8	GND	18	HDMI3_5V
9	HDMI3_RX0-	19	HDMI3_HOT_PLUG
10	HDMI3_RXCLK+		

CN604(to HDMI4)			
1	HDMI4_RX2+	11	GND
2	GND	12	HDMI4_RXCLK-
3	HDMI4_RX2-	13	CEC
4	HDMI4_RX1+	14	NC
5	GND	15	HDMI4_SCL_DDC
6	HDMI4_RX1-	16	HDMI4_SDA_DDC
7	HDMI4_RX0+	17	GND
8	GND	18	HDMI4_5V
9	HDMI4_RX0-	19	HDMI4_HOT_PLUG
10	HDMI4_RXCLK+		

CN302(to Speaker)			
1	R+	3	L+
2	R-	4	L-

OP301(to Optical Jack)			
1	SPDIF_OUT	3	GND
2	B5V_DC_PW		

CN1501(USB1)			
1	B5V_USB1_PW	3	USB1_DP
2	USB1_DM	4	GND

CN1502(USB2)			
1	B5V_USB2_PW	3	USB2_DP
2	USB2_DM	4	GND

CN1503(USB3)			
1	B5V_USB3_PW	3	USB3_DP
2	USB3_DM	4	GND

CN1402_LAN			
1	LAN_TXD+	5	B2.5V
2	B2.5V	6	LAN_RXD-
3	LAN_TXD-	7	NC
4	LAN_RXD+	8	GND

CN1201(to Function/IR)			
1	IR	14	A5.3V
2	GND	15	LED_STB
3	GND	16	BT_WAKE
4	FRAME_SYNC_IN	17	IR_GND
5	A3.3V	18	POWER_DET
6	BT_SYNC	19	NC
7	MSCL	20	BT_RESET
8	GND	21	NC
9	MSDA	22	NC
10	USB_BT_DP	23	GND
11	KEY_INPUT1	24	WIFI_DP
12	USB_BT_DM	25	WIFI_DM
13	KEY_INPUT2	26	B5V_DC_PW

CN502(to Component&AV)			
1	GND	9	COMP2_PR
2	COMP2_Y_CVBS	10	COMP2_PR
3	INDENT_VIEDO2	11	GND
4	GND	12	COMP2_PB
5	COMP2_PB	13	INDENT_COMP2
6	INDENT_COMP2	14	GND
7	GND	15	COMP2_Y_CVBS
8	COMP2_PR		

CN304_NIRB_1~7 (to Headpune&LR OUT)			
1	GND	5	TEST_SR
2	HP_LINE_SL_OUT	6	IDENT_HP
3	HP_LINE_SR_OUT	7	GND
4	TEST_SL		

CN303_IBR_1~14			
1	GND	5	TEST_SR
2	HP_LINE_SL_OUT	6	IDENT_HP
3	HP_LINE_SR_OUT	7	GND
4	TEST_SL	8	GND
9	IRB	12	NC
10	IRB	13	IPR_JACK_ID
11	NC	14	GND

CN201(to Power board)			
1	B5.3V_PW	11	B13V_PW
2	SW_POWER_OUT	12	ECO_ON
3	B5.3V_PW	13	B13V_PW
4	A5.3V_PW	14	CPLD_PWM1
5	GND	15	GND
6	GND	16	CPLD_PWM2
7	B12VS_PW	17	OVD_ON_OFF
8	GND	18	CPLD_PWM3
9	GND	19	OVD_LEVEL
10	SW_INVERTER	20	CPLD_PWM4

5-3. Connector Functions

Connector	Function
CN201_3D ↔ IP CNM803	Supply main power and dimming signal from IP Board to Main Board.
CN1401_FHD ↔ FRC+T-CON	The LVDS signal transferred from Main Board to Panel.