

Service Service Service

Philips Consumer Lifestyle



HR2200/80
HR2200/81

Service Manual

Technical information

- Voltage : 220V-240V
- Frequency rated : 50Hz
- Motor Power rated : 120W
- Heating Power rated : 900-990W
- Product dimensions(LxDxH) mm
205x153x310mm
- Capacity :1000~1200ml
(for2~4 people)
- Net Weight : 2.0kg

Material

- Jug : Stainless steel
- Blade :stainless steel
- Motor housing : PP (food contact)

Difference in Power Cord:

HR2200/80



HR2200/81
For UK



Product introduction

Control panel

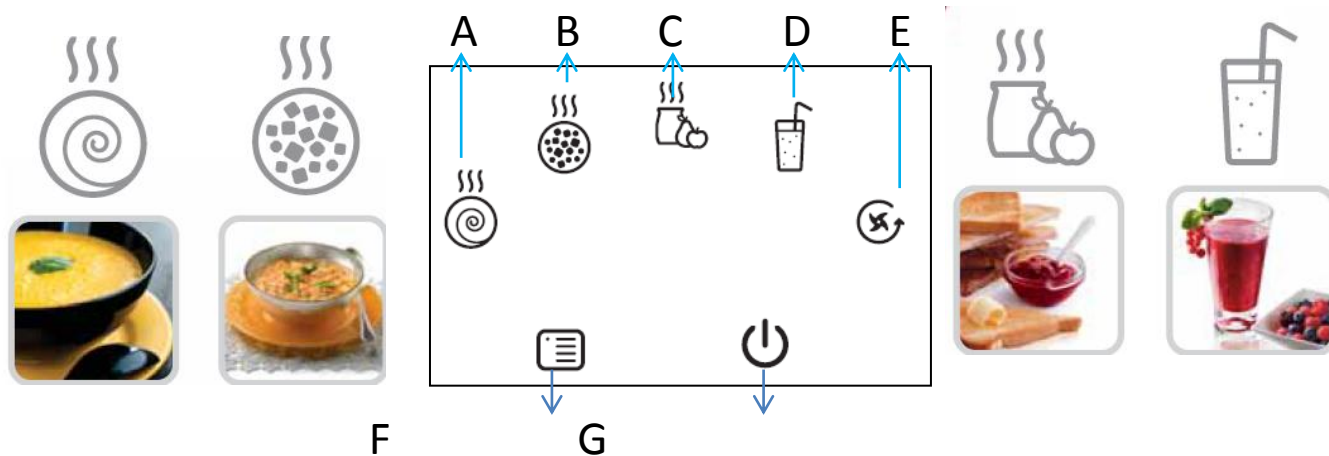

- A: Smooth soup program with light. → Smooth soup program to make a smooth soup in 23 minutes.
- B: Chunky soup program with light. → Chunky soup program to make a chunky soup in 20 minutes.
- C: Compote program with light. → Compote program to make a compote in 13 minutes.
- D: Smoothie program with light. → Smoothie program to make a smoothie in 3 minutes.
- E: Manual blending program with light
- F: Program selection button
- G: Start/stop button

Main features

<p>①</p> 	
<p>②</p> 	<p>DC motor, light weight and small noise</p>
<p>③</p> 	<p>Unique blade design, perfect blading performance. Cageless design, easier clean</p>
<p>④</p> 	<p>Streamlined raised surface, ensure perfect blading performance</p>

Technical information

- Electrical diagram:

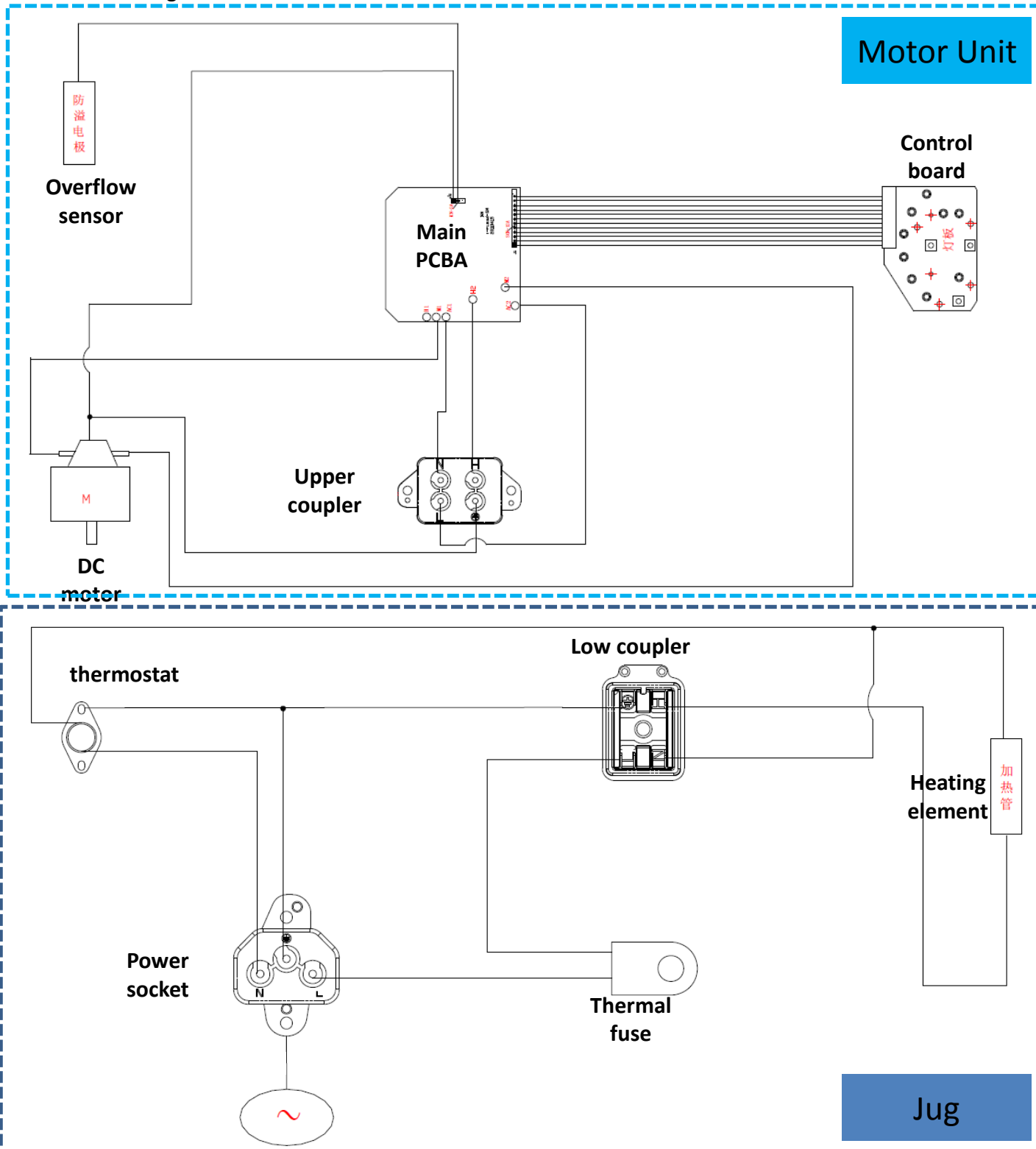

Exploded drawing

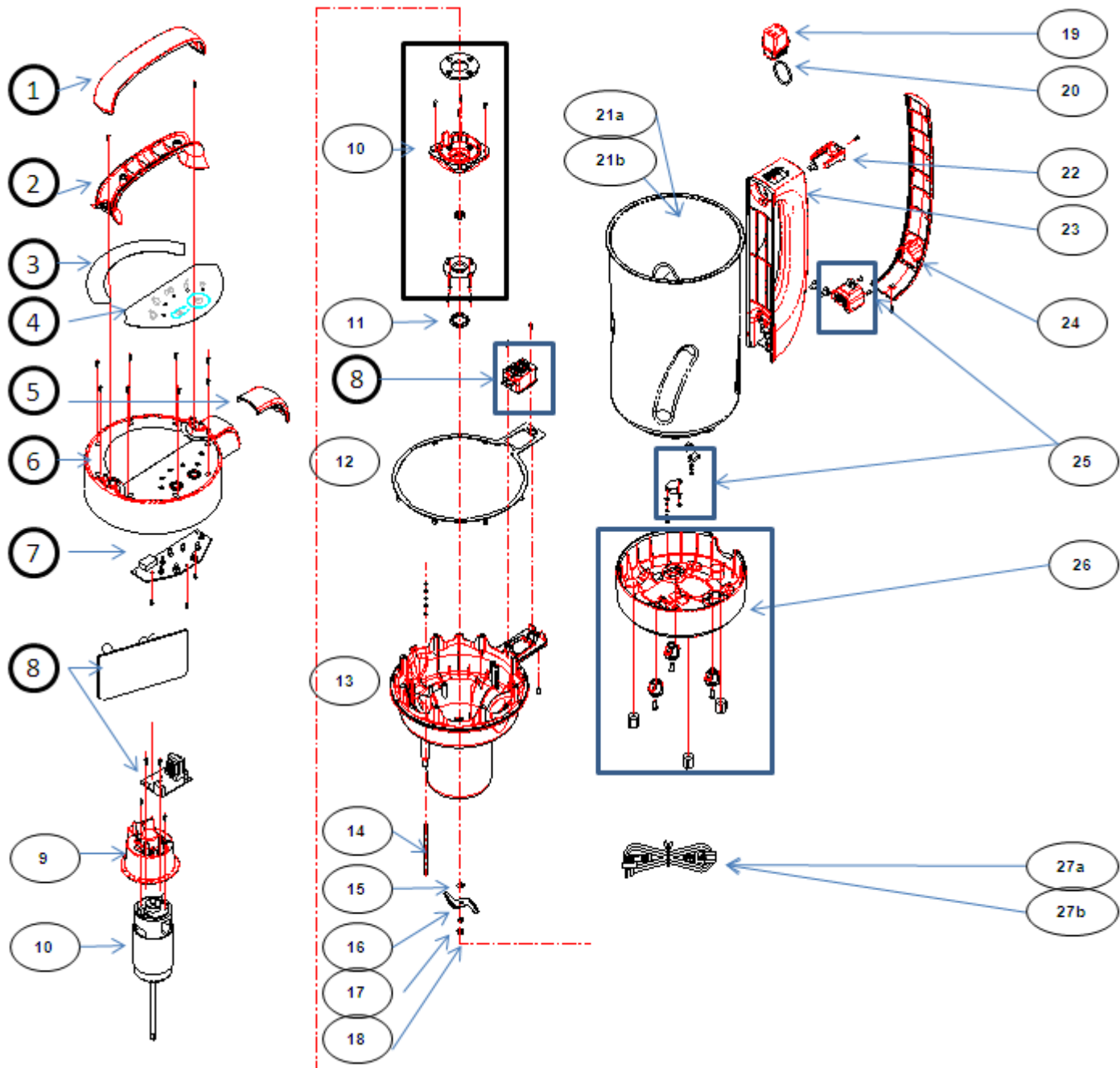

Spare parts

Position	12NC	Part name	PCM	Remark
1	996510054806	LID HANDLE COVER	Q776K200Y80R	
2	996510057705	LID HANDLE	Q776K360850R	
3	996510057699	SCREW COVER	Q776G955H14R	
4	996510057702	CONTROL PANEL	Q7760095H14R	
5	996510057703	LID COVER	Q7763650850	
6	996510057692	LID	B776298S203R	
7	996510057696	KEY PCB	D9776033002R	
8	996510057691	MAIN PCBA	A7761000002R	
9	996510054782	MOTOR COVER	Q7769420B55R	
10	996510057694	MOTOR ASSY	A7760210002R	
11	996510049007	MOTOR BRACKET SEAL	X6001350001R	
12	996510054807	LID SEAL	X7762820001R	
13	996510054804	ANTI-SPILL SENSOR ASSY	B776328S201R	
14	996510057695	MOTOR HOUSING	Q776D490839R	
15	996510048973	BLADE WASHER	J0200000118R	
16	996510054793	BLADE	J2420000095R	
17	996510048971	DIAMETER 5 SPRING WASHER	J0150000437R	
18	996510048969	M5 LOCK NUT	J0020000186R	
19	996510057698	LOWER COUPLER ASSY	A7767060002R	
20	996510054785	SEAL FOR LOWER COUPLER	X6920930001R	
21a	996510057693	INNER PAN ASSY (220V)	A7766110002R	
21b	996510057706	INNER PAN ASSY (230V)	A7766110003R	for UK
22	996510048981	COUPLER HOLDER	Q616371AB01	
23	996510054797	CUP HANDLE	Q776F540Y80R	
24	996510057697	CUP HANDLE COVER	Q776A92A850	
25	996510057701	SOCKET ASSY	A7764970002R	
26	996510054799	CUP BASE ASSY	B776084S201R	
27a	996510057704	POWER CORD (2 PINS)	D1AF104D001R	
27b	996510057707	POWER CORD (3 PINS)	D1AH204D001R	for UK

DISASSEMBLY ADVISE



Before you start dismantling!
For your safety be sure the plug is disconnected from the mains!

Step 1: Remove the upper handle.



Step 2: Remove control panel and screw cover (adhesive label), you can touch eight screws.

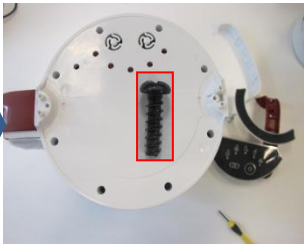

Screw cover

Step 3: Remove 9 fixing screws. You can get main PCBA, Key PCB.

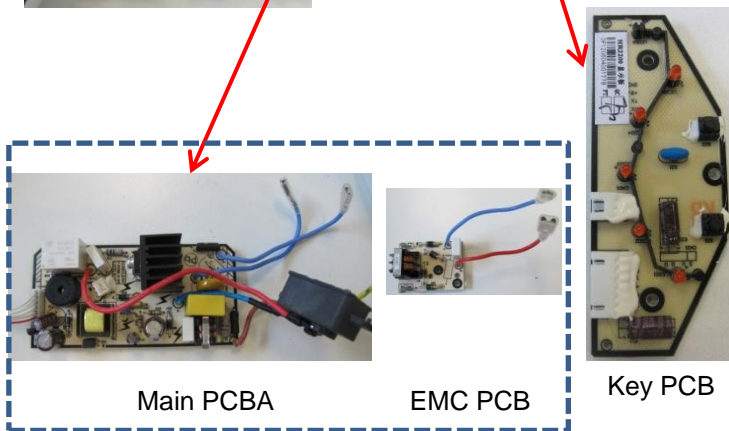
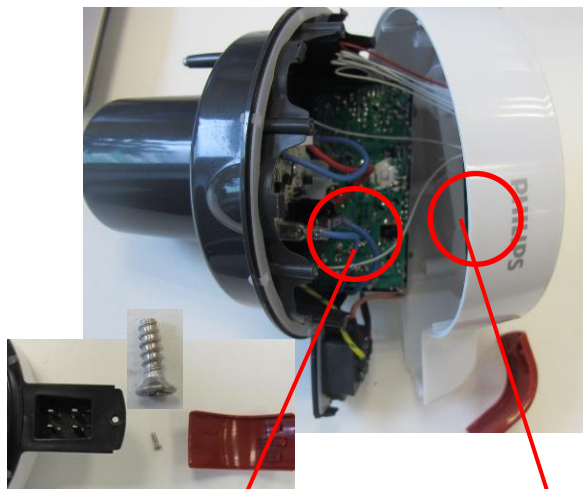

Main PCBA Assy

How to replace DC motor.

Step 1: Remove main PCBA and EMC PCB.

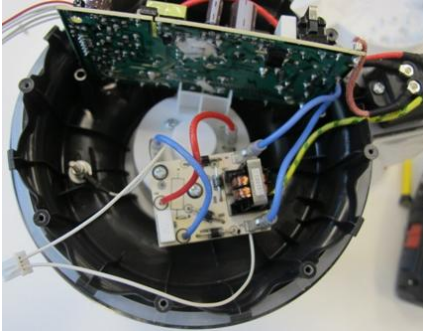

Easy-to-click design, easy to remove main PCBA.

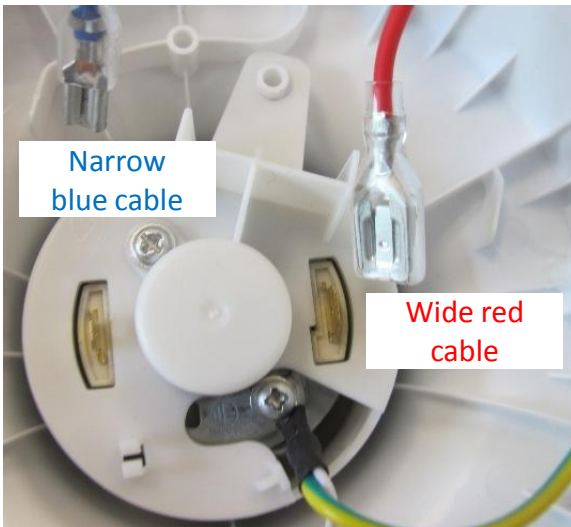

Step 2: Remove blade with spanner.



Step 3: Remove dust-protect cover.



Step 4: Remove 4 fixing screws, then you can get out the motor.

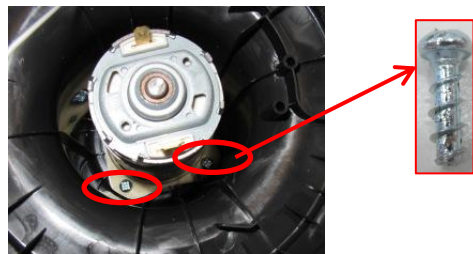

DC motor

Trouble shooting

Overflow

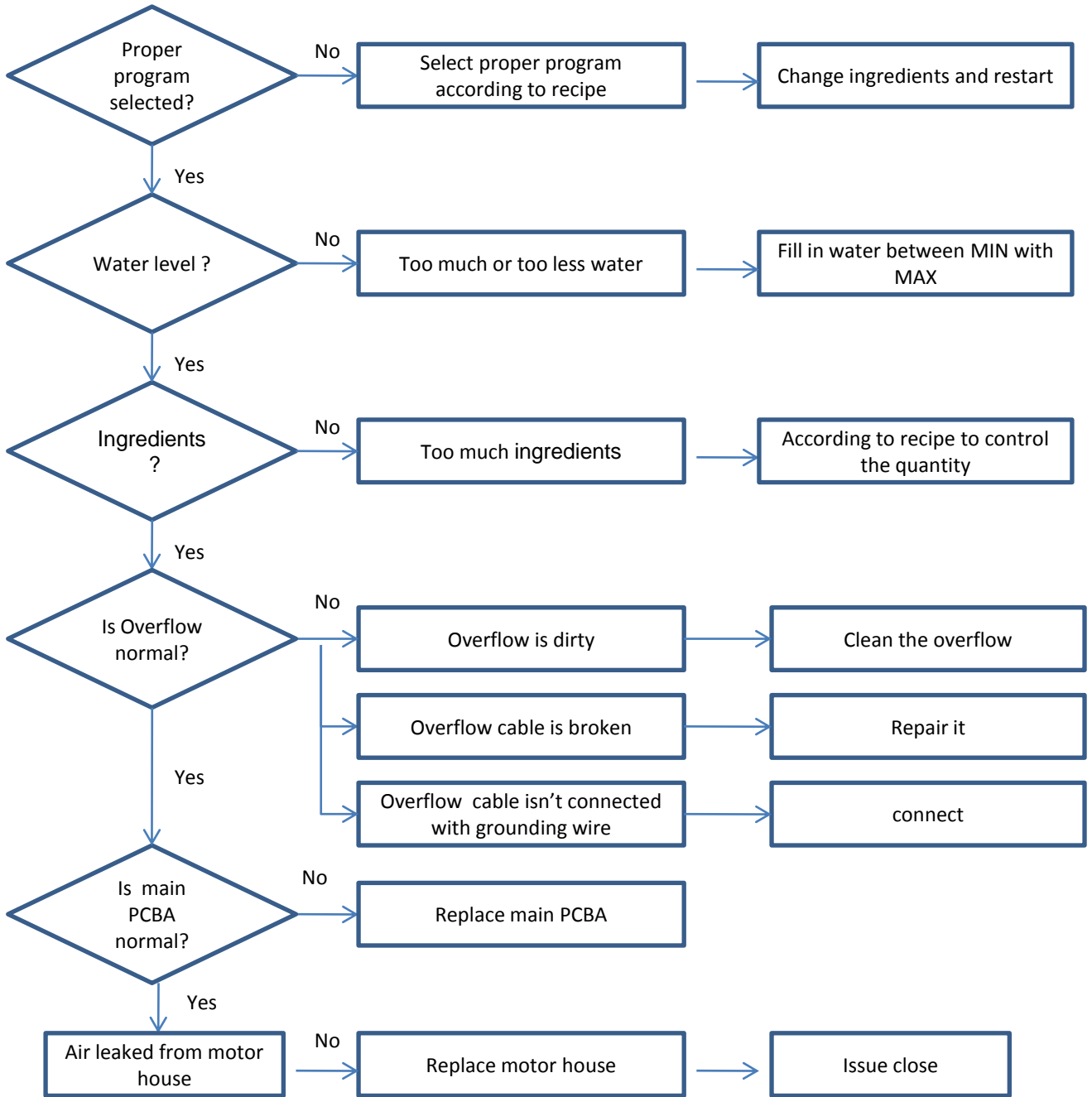

Trouble shooting

After 20 minutes, ingredients are not bladed.

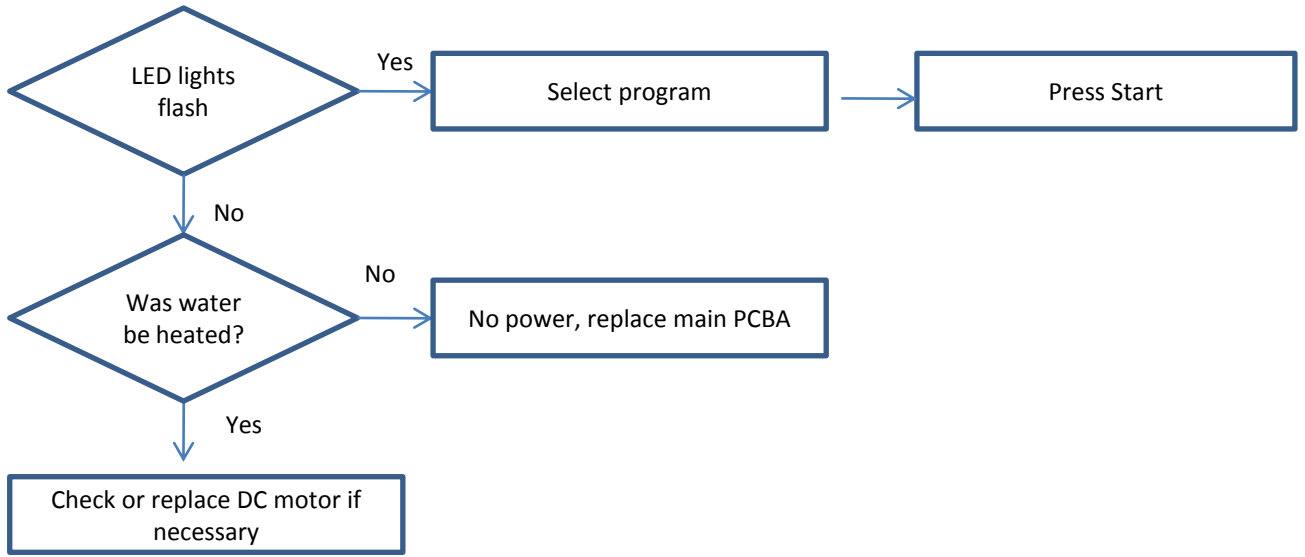

Alarming when power cord plugs in

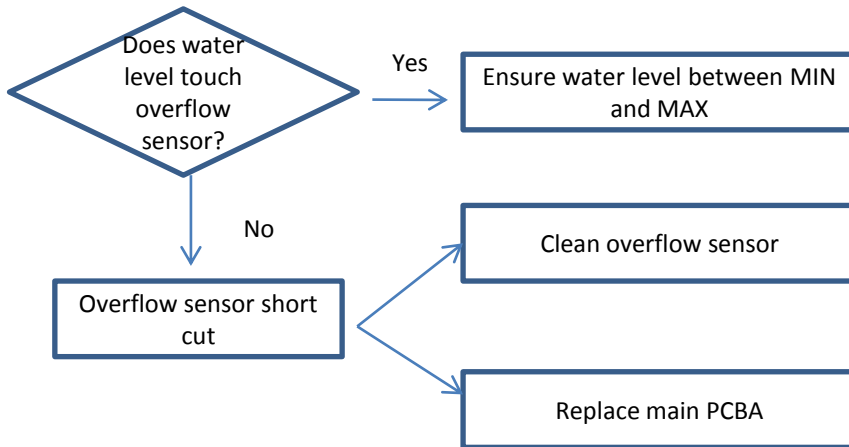

Trouble shooting

Problem	Cause	Solution
The appliance doesn't work	There is connection problem	Check if the small plug is inserted in the appliance properly and if mains plug is inserted in the wall socket properly. Remove the plugs and reinsert them.
	The motor unit does not fit onto the jug properly because there are too many ingredients in the jug.	Remove some of the ingredients and make sure not to fill the jug beyond the MAX indication.
	Motor unit problem	Please contact with local service center or call center
The light of selected mode doesn't go on	There is connection problem	Check if the small plug is inserted in the appliance properly and if mains plug is inserted in the wall socket properly. Remove the plugs and reinsert them.
	During making process, power had been cut off.	Please follow the proper steps to make soup.
	The motor unit does not fit onto the jug properly	Make sure motor unit connector and the jug connector are aligned before you lower the motor unit into the jug.
	You have exceeded the MAX indication in the jug.	Remove some of the ingredients and make sure the ingredients are spread evenly over the bottom of the jug.
The light of selected program is on, but the appliance doesn't work	You have not pressed start button.	Press the start button.
	You have exceeded the MAX indication in the jug.	Remove some of the ingredients and make sure the ingredients are spread evenly over the bottom of the jug.
The ingredients have not blended well	You have exceeded the MAX indication in the jug	Remove some of the ingredients and make sure the ingredients are spread evenly over the bottom of the jug.
The appliance overflows	You have selected wrong program	Select correct program according to recipe
	You have exceeded the MAX indication in the jug	Remove some of the ingredients and make sure the ingredients are spread evenly over the bottom of the jug.
	The overflow sensor is dirty	The overflow sensor prevents the appliance from overflowing. Clean the overflow sensor.
The food is burnt	You have selected wrong program	Select correct program according to recipe
	You did not add enough water or other liquid	Make sure the liquid level is above the MIN and below the MAX indication.
	You have heated up milk	The soup maker is not suitable for heating up milk.

This chapter summarises the most common problems you could encounter with the appliance. If you are unable to solve the problem with the information below, visit www.philips.com/support for a list of frequently asked questions or contact the Consumer Care Centre in your country.