

A76

Service Manual

REVOX

Service Manual

REVOX A76

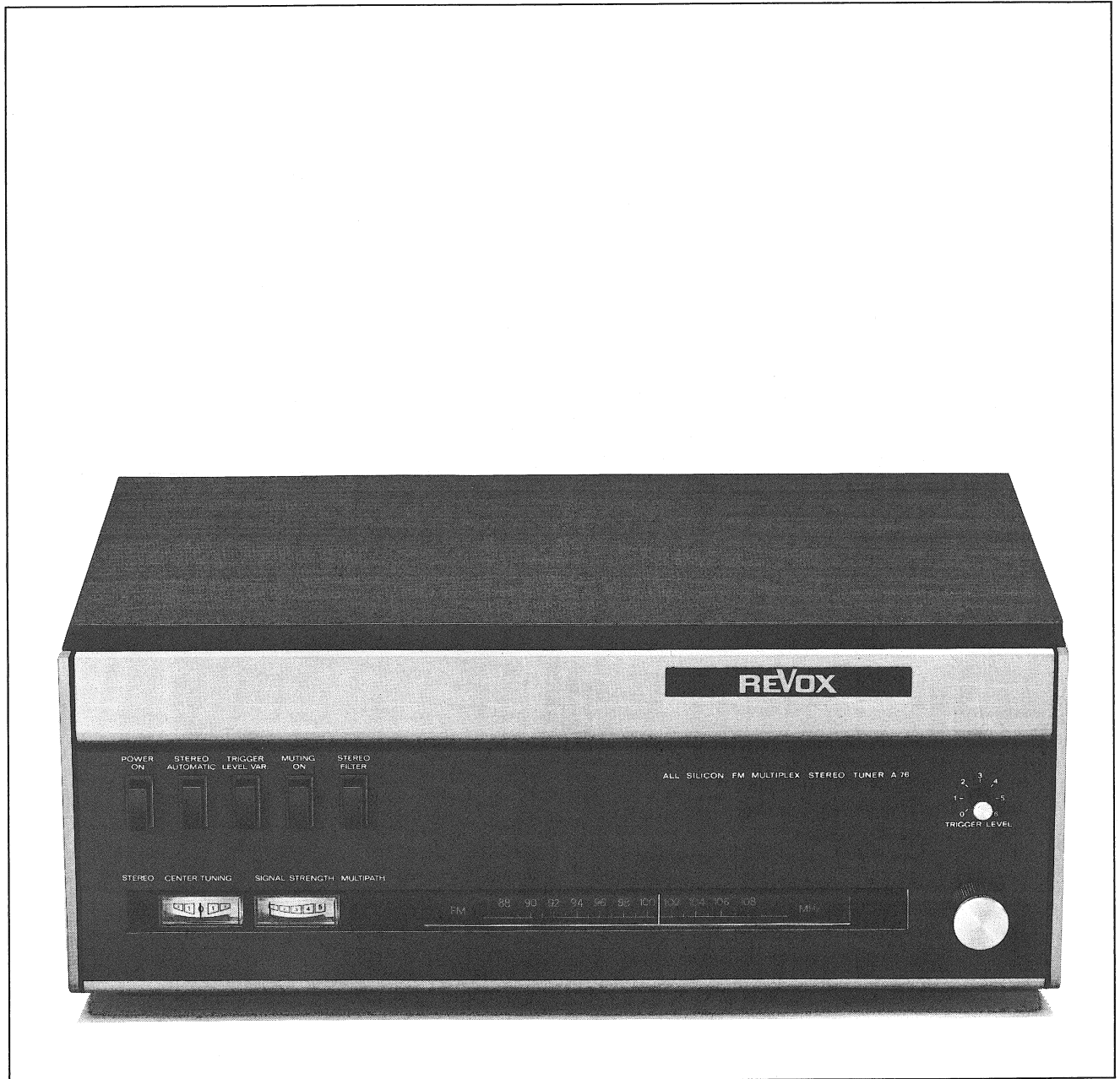

Contents

	Page
1. GENERAL	4
2. DISMANTLING	4
2.1. Removal of front panel	4
2.2. Removal from cabinet	4
2.3. Lacing of dial cord	4
3. CIRCUIT DESCRIPTION	5
3.1. Operating controls	5
3.2. Schematics	5
3.3. RF input section (front end)	5
3.4. IF-section	6
3.5. Demodulator	6
3.6. Subcarrier re-generation	6
3.7. Multiplex decoder	7
3.8. Indicator circuits	7
3.9. Power supply	8
4. ALIGNMENT INSTRUCTIONS	9
4.1. Test equipment	9
4.2. Additional tools and filters	9
4.3. Checking of supply voltages	10
4.4. Tuning of IF filters	10
4.5. Alignment of center tuning discriminator	11
4.6. Checking the selectivity	11
4.7. Alignment of RF input section	12
4.8. Alignment of IF amplifier	13
4.9. Checking symmetry of the center tuning meter (44)	13
4.10. Checking for correct limiting	13

	Page
4.11. Sensitivity check on the center tuning (44) and the signal strength meters (43)	13
4.12. Alignment of FM demodulator	14
4.13. Alignment of multipath indicator	14
4.14. Alignment of subcarrier oscillator (76 kHz)	15
4.15. Alignment of 19 kHz circuit	15
4.16. Alignment of 38 kHz circuit	16
4.17. Tuning of the 19 kHz band pass filter	16
4.18. Alignment of multiplex filter	17
4.19. Adjustment for minimum stereo crosstalk	17
4.20. Checking of automatic mono-stereo changeover	18
4.21. Checking range of output potmeters	18

5. INSTRUCTIONS FOR MEASURING THE MOST IMPORTANT PERFORMANCE DATA

5.1. Input sensitivity	19
5.2. Static selectivity	19
5.3. Image response	20
5.4. Spurious response	20
5.5. Distortion	21
5.6. Signal to noise ratio	21
5.7. Stereo separation (crosstalk)	21
5.8. Frequency response	22

6. TECHNICAL DATA

23

7. SCHEMATICS

25

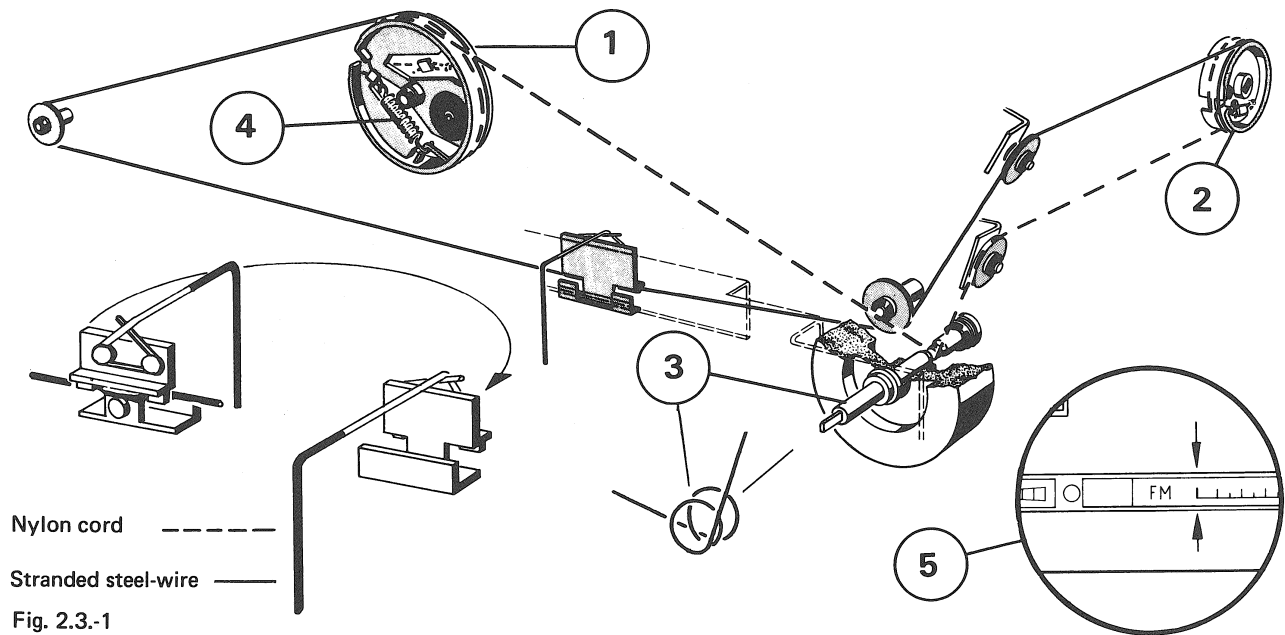

Fig. 2.3.-1

1. GENERAL

The REVOX A76 FM-Stereo Tuner is a piece of high quality equipment which passes through a series of scrupulous tests during production as well as a very careful final inspection. Therefore, when servicing this tuner, it is absolutely necessary to check all vital data in order to ensure that the original characteristics will be maintained.

Important

When soldering Field Effect (FET) and Radio Frequency Transistors the following precautions must be observed: Tuner must be turned off.

Work with earthed soldering iron only.

Provide electrical contact between tip of iron and tuner chassis.

2. DISMANTLING

2.1.

Removal of front panel

- pull rotary knobs from their shafts
- carefully pull off front panel which is held by six snap-on fasteners

2.2.

Removal from cabinet

- place top side of cabinet onto a soft pad
- undo four chassis mounting screws
- pull chassis from the cabinet
- remove spacerplates (with rubber strips)
- remove upper and lower shielding panel

2.3.

Lacing of dial cord

2.3.1.

Stranded steel-wire

- Take off pulley (1) and orient it so that the hole between two angled eyelets is in 12 o'clock position.
- Lace large loop of steel wire through left hand eyelet and wind 1 1/2 turns of wire onto pulley. Slide pulley onto shaft and secure it by pushing a suitable rod (round needle file) through hole in pulley and hole in panel behind.
- Lace wire over guide rollers, along pointer slide and hook onto removed drive-pulley (2)
- Turn tuning capacitor ccw to stop, slide drive pulley with slot pointing downwards onto capacitor shaft.
- Turn drive pulley cw to stop. (Allow 1 to rotate). In this position there must be exactly 2 turns of steel cord on the drive pulley.

2.3.2.

Nylon cord

- Find approx. centre of cord and wind 2 turns onto drive shaft (3)
- Take off drive pulley (2) and connect R.H. end of cord. Put drive pulley back onto cap shaft, slot pointing upwards.
- Turn pulley (1) cw to stop and attach nylon cord via spring (4) to the R.H. eyelet.
- Run dial drive several times back and forth and check for proper winding of dial cords.

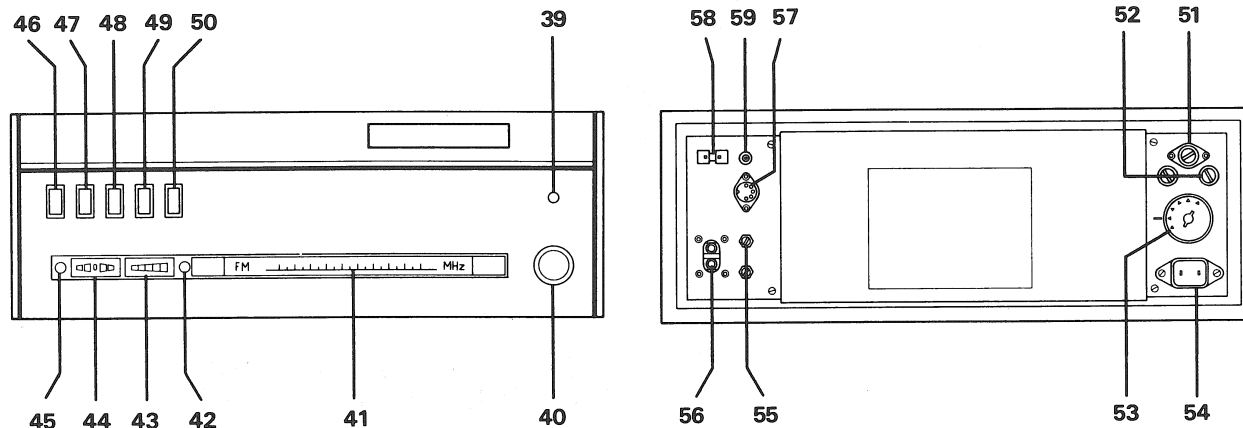

Fig. 3.1.-1

2.3.3.

Positioning of dial pointer

- Turn drive shaft (3) ccw until it stops with the tuning capacitor fully closed
- attach pointer slider to steel wire
- with front panel and dial installed, slide pointer to the left hand end of the horizontal line on the dial (5) .

3. CIRCUIT DESCRIPTION

3.1.

Operating controls

The index numbers on all operating controls are identical to those used in the Operating Instructions (see fig. 3.1.-1).

3.2.

Schematics

The following schematics are contained in section 7 of this manual:

3.2.1

Functionally grouped Block diagram

One group function corresponds to one actual circuit board.

3.2.2.

Interconnecting diagram showing all power supply and signal connections.

Please note:

The circuit of the push-button assembly (G) 1.076.291 is shown on this interconnecting diagram only.

3.2.3.

Complete circuit diagram with signal connections. On this diagram the switching elements of the push-button assembly are shown as peripheral circuit elements.

3.3.

RF input section (front end) (schematic A)

1.076.150

The signal arriving on the 60 ohms or 240 ohms antenna sockets is fed via a balancing transformer (Balun) to the tuned RF-input stage with its FET Q101. Coupling to the mixer Q102 is achieved through the band-pass formed by L104/ L105.

The RF signal from the stabilized oscillator Q104 passes through the buffer stage Q103 and reaches (via the oscillator

- A RF input section
- B IF section
- C Demodulator
- D Subcarrier re-generation
- E Multiplex decoder
- F Indicator circuits
- G Pushbutton board
- H Power supply

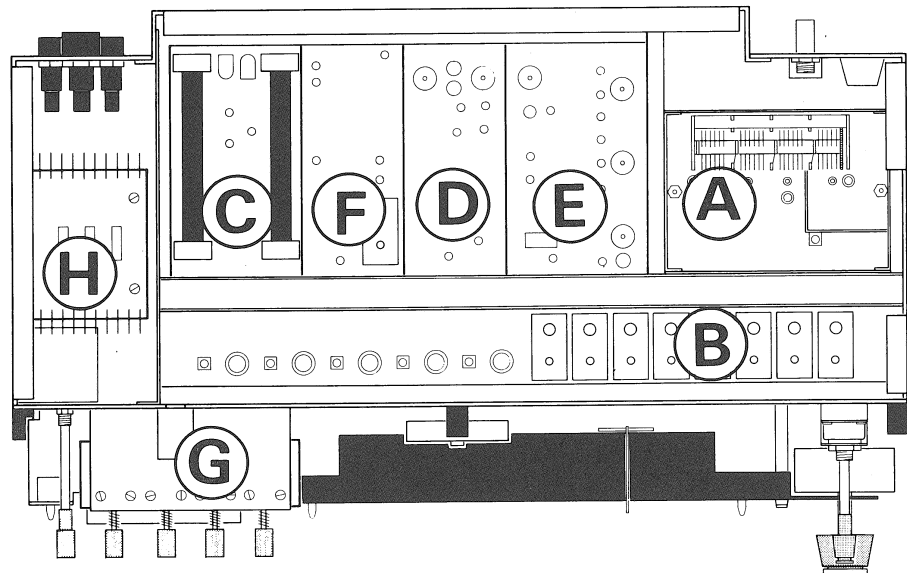

transformer L108) GATE 2 of the mixer Q102. The buffer-stage Q103 serves to prevent interactions between mixer and oscillator. The IF signal is taken from the balanced output of L106.

3.4. IF-section 1.076.170
(schematic B)

In order to achieve constant transmission characteristics, IF-filters and IF-amplification are completely separate entities. Effective signal selection is concentrated in the passive filter-section which lies ahead of the IF amplifier and is therefore entirely independent of signal amplitude or limiting action.

The filter consists of eight individually tuned parallel resonant L/C circuits and has a bandpass characteristic which approximates the Gaussian probability distribution over the range of ± 120 kHz (fig. 3.4.-1).

In that range, the envelope delay remains virtually constant (fig. 3.4.-2) resulting in excellent performance with regard to keeping any modulation distortion at a minimum.

The IF-amplifier which follows is made up of five Integrated Circuits (IC's) each one being a separate amplifier with a differential input stage. Limiting in the last IF stage is already effective at a level equalling the tuners input noise, therefore the audio output signal will remain constant from the lowest antenna input ($1 \mu\text{V}$) on upward. Figure 3.4.-3 illustrates the audio signal to noise ratios for stereo and mono operation, starting at the point from where limiting becomes effective.

Level dependent DC currents are branched off from the diodes D201, D202 and D203 for signal strength indication. By adding those currents a pseudologarithmic indication characteristic is achieved which allows evaluation of signal-strengths ranging from a few microvolts up to approx. 10 mV. For centre tuning indication a signal is taken from the fourth IF stage and fed to a separate narrow-band detector (indicator circuits).

For silent tuning and muting of weak stations (button "MUTING ON" (49) depressed) the last IF stage may be biased into cutoff by the variable trigger (indicating circuits) whereby the triggering point is adjustable to the desired signal strength.

3.5. Demodulator 1.076.190
(schematic C)

Demodulation of the frequency modulated signal is achieved in a delay-line demodulator. This demodulator is made up of a driver stage formed by the differential amplifier with transistors Q301, Q302 and Q303, two coaxial delay-lines (with an electrical length equalling $\lambda/8$ of the intermediate frequency) as the load impedance and D301/D302 as the rectifying circuit. In this arrangement FM is being changed into AM by the frequency dependent impedance of the two coax line sections, one of which is open whereas the other is short circuited at the end by capacitor C308.

This delay-line demodulator has a bandwidth of 5 MHz. This in connection with the broadband characteristics of the IF-amplifier (5 MHz) results in a capture ratio of 1 dB thereby ensuring excellent common frequency suppression. The operating principle of the delay-line demodulator makes for a simple circuit which is free of any critical components and tuning elements (AM suppression depends entirely on the limiting characteristics of the IF amplifier).

The multiplex signal is taken off at trimpot P301 (DC-Balance) and is tripped of its IF components by an RC-network. The output voltage of the demodulator has a value of 15 mV approx. (at 75 kHz deviation) and is then amplified to 1 V approx. by the multiplex amplifier Q304, Q305 and Q306.

3.6. Subcarrier re-generation 1.076.210
(schematic D)

The 38 kHz subcarrier is re-generated in a phase locked loop oscillator. The oscillator together with the differential

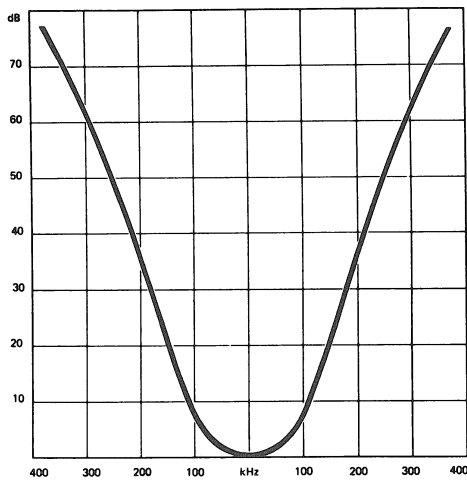

Fig. 3.4-1

amplifier Q405 and Q406 produces a 76 kHz frequency which, after pulse shaping, passes IC 401 operated as a frequency divider at the ratio of 1:2:4. The resulting 38 kHz (subcarrier) is then used to operate the switching demodulator. The 19 kHz signal from the frequency divider is fed to the phase comparator Q403/Q404 where it is compared with the pilot-frequency arriving from the bandpass L401/L402.

The 15 Hz low-pass filter formed by R409, C408, R410 prevents any interference components in the pilot signal from reaching the varicap diodes D402 in the 76 kHz oscillator. This arrangement operates in the manner of a narrow pilot frequency bandpass with a ± 15 Hz bandwidth. The bias voltage for the varicap-diodes is obtained from the Zener-diode D401.

3.7.

Multiplex decoder (schematic E)

1.076.220

The Multiplex-Decoder operates on the switching principle. Separation of the multiplexed signal takes place in the low-pass network R508, C504, R509 for the main channel and in the 38 kHz bandpass L501, C501, R502 for the sub-carrier or difference channel. Amplification of the sub-carrier takes place in Q501 whereas Q503 and Q504 operate as the switching demodulator.

The switching principle was selected because in contrast to envelope-detection it transposes only those frequencies in the audible range which are uneven multiples of the sub-carrier. Thus the lowest critical interference frequencies occur around 114 kHz and they are effectively suppressed by the 114 kHz filter L505 - C518 and the 38 kHz bandpass in the difference channel.

Across the load resistors R518/R519 the signals L-R and - (L-R) are being formed, with the main signal appearing in phase across those load resistors. Any residual components are suppressed by the in-phase operation of the differential amplifier Q505 and Q506, which works at the same time as the matrix by forming the L and R signals from the difference channel and from the main channel, which arrives from the Q502 amplifier.

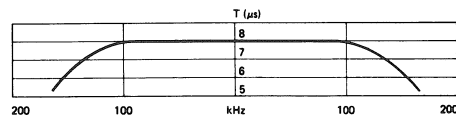

Fig. 3.4-2

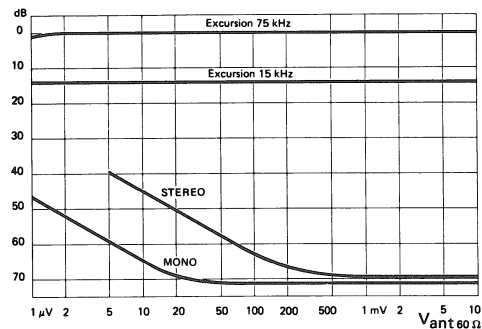

Fig. 3.4-3

A low pass 15 kHz filter to suppress multiplex residuals is situated between the impedance matching stages Q507/Q508 and the matrix output. The audio level at the low impedance outputs is adjustable from 50 mV to 1 V, referenced to an FM deviation of 75 kHz.

3.8.

Indicator circuits (schematic F)

1.076.200

This portion of the tuner contains the auxiliary circuits for tuning indication and for various automatic functions.

The IF-signal arriving from the fourth IF stage is amplified by Q601 and then passed to a narrow band detector whose small band-width produces the sensitive response of the "CENTER TUNING" (44) meter.

As already mentioned in a previous chapter, a level dependent current for signal strength indication is derived from the first three IF stages and fed to the "SIGNALSTRENGTH" meter after amplification in the Q602 amplifier.

The level dependent triggering circuit formed by Q604 and Q605 delivers a gating signal to the base of Q510 in the stereo decoder for mono-stereo changeover and also biases the last IF stage for noise squelch and silent tuning. By depressing the button "TRIGGER LEVEL VARIATION" (48) R702 in the collector leg of Q602, which normally provides maximum sensitivity, is replaced by the potentiometer "TRIGGER LEVEL" (39). This allows a wide variation of the triggering point with consequent muting even of rather powerful stations. With the button "MUTING ON" (49) released, the triggering circuit will respond for automatic mono-stereo changeover only.

In the multiplex decoder the circuit formed by Q510/Q511 and Q512 analyses whether or not the following conditions are met for automatic changeover to stereo operation:

1. signal from the level dependent trigger (input base Q510)
2. presence of a pilot signal. (This signal is derived from the band-pass in the sub-carrier regenerating module. It is amplified by Q509 and then rectified by the diode D502).

3. mono-stereo switch "STEREO AUTOMATIC" (47) depressed (thus allowing a signal to reach the base of Q511).

With all three conditions satisfied, Q512 becomes conductive and the difference channel amplifier Q501 begins to operate.

With the switching of Q512 the stereo indicator "STEREO" (output EG 1) will also receive current.

For multipath indication "MULTIPATH" (42) the multiplex signal is being fed to the monostable trigger Q608/Q607 and signal is fed to the monostable trigger Q608/Q607 and receiving direct and reflected signals, will trigger that circuit into the conductive mode, thereby causing the light bulb "MULTIPATH" to become illuminated (button "MULTIPATH INDICATOR" (50) depressed).

3.9.

Power supply	1.076.130
(schematic H)	1.076.140

The power supply consists of two electronically regulated sections for -23 V and $+23$ V. Zener diodes stabilize the supply voltages -6.2 V and $+6.2$ V which feed the integrated circuits in the IF amplifier auxiliary circuits.

* Modifications MK II *

Tuners of the MK II version have the function MULTIPATH INDICATOR replaced by the button labeled STEREO FILTER (50). Therefore the circuit of the indicator light MULTIPATH can no longer be switched off.

With button STEREO FILTER, the signal to noise ratio of weak or distant stereo stations can be improved. This is being achieved by reducing the bandwidth of the 38 kHz resonant circuit L501/C501 (raising the Q by disconnecting the 8.2 kohm resistor). The narrow bandwidth of the 38 kHz filter results in a reduced stereo base; stereo crosstalk drops to 10 dB at 1 kHz.

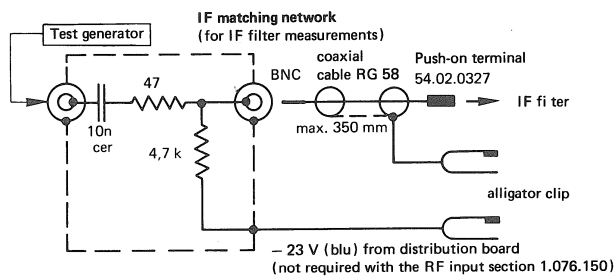

Fig. 4.2.-1

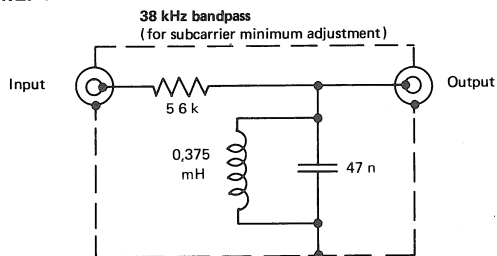

Fig. 4.2.-2

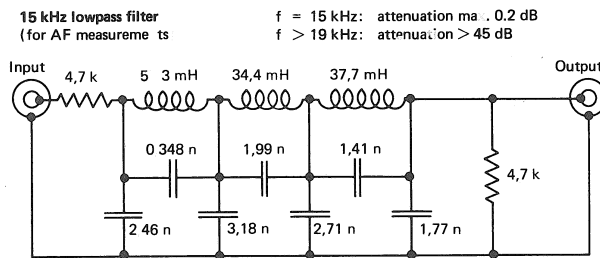

Fig. 4.2.-3

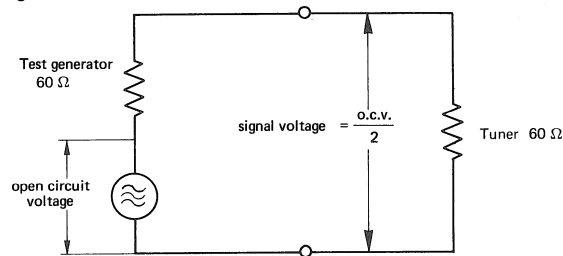

Fig. 4.2.-4

4. ALIGNMENT INSTRUCTIONS

4.1.

Test equipment

For correct alignment the following test equipment (or equivalents) will be required:

Stereo test generator Rohde & Schwarz type SMSF BN 41410, range 87 to 108 MHz and 10.2 to 11.2 MHz

Stereo modulator Philips PM 6450

Audio generator low distortion type (THD less than 0.05 %)

Digital counter (for 38 kHz)

Oscilloscope (with internal and external triggering) including RF probe 10:1

DC transistor or vacuum tube voltmeter (VTVM) including RF probe

Multimeter for supply voltages

Distortion analyser (or audio millivoltmeter with suitable filters)

4.2.

Additional tools and filters

One set of cables (coaxial cable RG 58)

One set of tuning tools

The following filters and matching networks are required for IF measurements, subcarrier minimum adjustment and audio frequency measurements. The construction of these circuits is not critical.

IF matching network fig. 4.2.-1 (for measurements on the IF filters)

38 kHz bandpass fig. 4.2.-2 (for subcarrier minimum adjustment)

15 kHz lowpass filter fig. 4.2.-3 (for audiofrequency measurements)

Note:

The signal voltage indicated for the stereo test generator is an open circuit voltage (o.c.v.). If the internal impedance of the test generator equals 60 ohms, a voltage of exactly 1/2 of the test generator's open circuit voltage will result across the 60 ohm input of the tuner (see fig. 4.2.-4).

When working with test generators whose output calibration is already taking into account the nominal load impedance of the equipment under test, the generator's output is to be set to one half of the indicated open circuit voltage.

The predominantly used test frequency of 94 MHz is to be taken as a guide only. Prior to starting any alignment procedures, it should be checked whether or not that frequency does not produce an interference with a neighbouring FM transmitter. (This should be checked with the test generator connected to the tuner, but with the signal turned off). If an FM broadcast can still be received, the test frequency should be altered slightly.

The stereo test generator is to be connected to the 60 ohm antenna input for all tests (except for the tuning steps 4.4 to 4.6 which require the test frequency to be fed via the IF matching network).

All readings are to be taken against chassis.

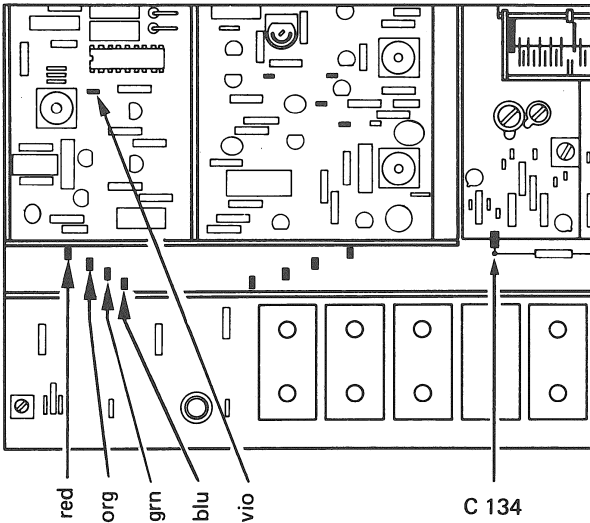

Fig. 4.3.-1

It is absolutely essential to check the supply voltages before attempting any alignment of the tuner.

4.3. Checking of supply voltages

Tuner switched on (power switch only, no other button depressed); voltage readings against chassis.

Current consumption on 220 V line: 65 mA

- red: + 23 V (+1 /-0 V) } Ripple voltage less than
- blu: - 23 V (+0 /-1 V) } 1 mV
- org: + 6.2 V (+0.5/-0.2 V)
- grn: - 6.2 V (+0.2/-0.5 V)
- vio: + 4 V (+0.8/-0.5 V)
- C125: - 15 V (± 0.8 V)

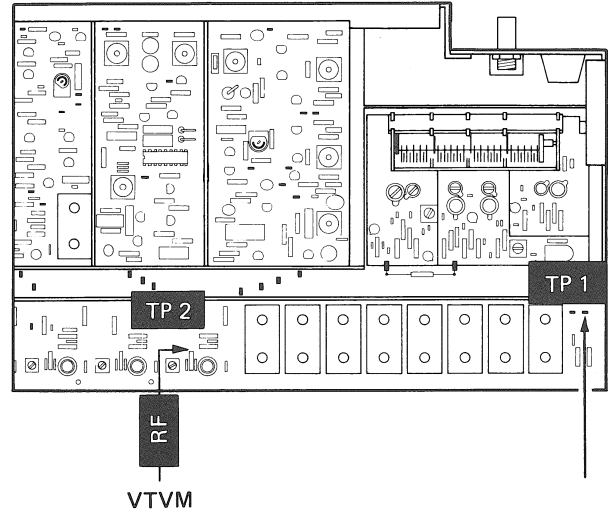

Fig. 4.4.-2

4.4. Tuning of IF filters

Important: All tuning slugs are to be positioned so as to produce a maximum when turned to their upper setting. (see fig. 4.4.-1)

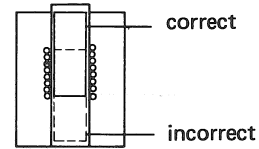

Fig. 4.4.-1

Test equipment

Test generator frequency 10.7 MHz (± 20 kHz), 63 mV o.c.v. no modulation

IF matching network (see fig. 4.2.-1)

VTVM with RF probe, range to read 0.9 V (+0.2/-0.1 V)

4.4.1. Tuner: power switch depressed

4.4.2. Remove spade lug AB 1 (test point 1) and connect IF matching network. (On tuners with the new RF section 1.076.160-1 the -23 V connection is not required).

4.4.3. Connect RF probe of VTVM to testpoint 2 (see fig. 4.4.-2)

4.4.4. Adjust slugs of the IF filters FT 201 to FT 208 to obtain an exact maximum voltage reading on the VTVM. This tuning procedure must be repeated until no improvement can be achieved any more.

4.4.5. Immediately following upon the tuning of the IF filters, the centre tuning discriminator must be aligned as described under section 4.5 (any frequency drift of the test generator would lead to an erroneous adjustment). **Important:** do not alter the frequency setting of the test generator.

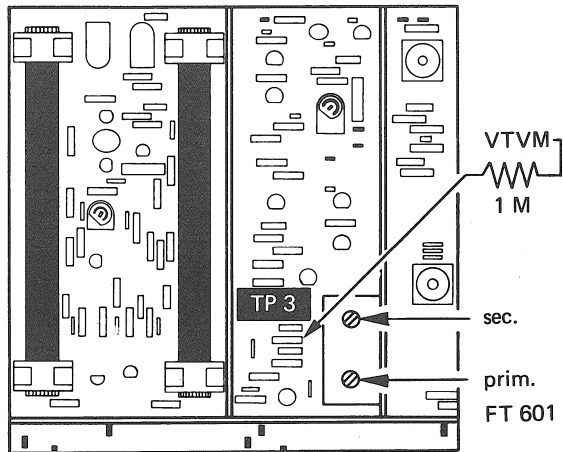

Fig. 4.5.-1

4.5. Alignment of center tuning discriminator (narrow band discriminator)

Important: The centre tuning discriminator FT 601 must be aligned immediately following the tuning of the IF filters (any frequency drift of the test generator would lead to an erroneous adjustment).

Test equipment:

Test generator, frequency 10.7 MHz (± 20 kHz) 63 mV o.c.v. no modulation.

IF matching network (see fig. 4.2.-1)

VTVM without RF probe, range to read DC + 8 V (+ 1 V / - 2 V)

4.5.1. Tuner:
Power switch depressed.

4.5.2.
IF matching network remains connected to test point 1 (see fig. 4.4.2.)

4.5.3.
Connect a resistor of 1 Mohm directly to test point 3 (see fig. 4.5.-1) and connect VTVM to that resistor

4.5.4.
Turn slug of secondary winding of discriminator FT 601 almost completely up (see fig. 4.5.-1)

4.5.5.
Adjust primary circuit by finding a maximum with the tuning slug in its upper position as described under 4.4. The voltage reading thus obtained should be from 6 to 9 V.

4.5.6.
Adjust slug of secondary coil until obtaining a zero indication on the centre tuning meter (44)

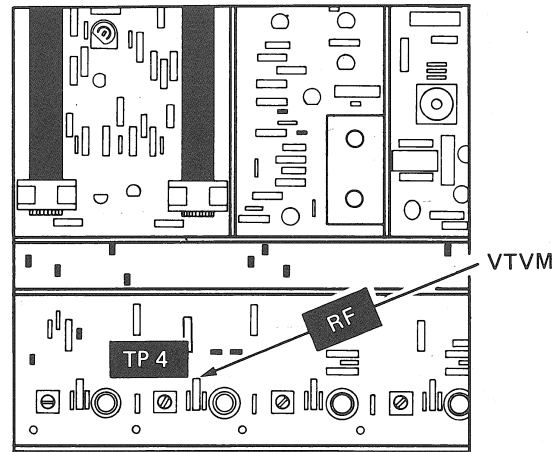

Fig. 4.6.-1

4.6. Checking the selectivity

A. Bandwidth

Test equipment:

Test generator, frequency 10.7 MHz (± 20 kHz) 63 mV o.c.v. no modulation

IF matching network (see fig. 4.2.-1)

VTVM with RF probe, range to read 1 V

4.6.1. Tuner:
power switch depressed

4.6.2.
IF matching network remains connected to test point 1 (see fig. 4.4.2.)

4.6.3.
Connect RF probe of VTVM to test point 2 (see 4.4.3. and fig. 4.4.-2.)

4.6.4.
Adjust output level of test generator to obtain a reading of 1 V on the VTVM

4.6.5.
Alter the frequency of the test generator by ± 65 kHz; this must reduce the VTVM reading to 0.7 V (-3 dB)

B. Static selectivity

To measure the static selectivity, a test generator is required whose open circuit output voltage can be attenuated to less than 1 μ V.

4.6.6.
Connect RF probe of VTVM to test point 4 (see fig. 4.6.-1)

4.6.7.
Adjust output voltage of test generator to its minimum (less than 1 μ V) and increase gradually until a reading of 1 V is obtained on the VTVM. During this test, no limiting must occur in IC 204. This can be checked by slightly increasing

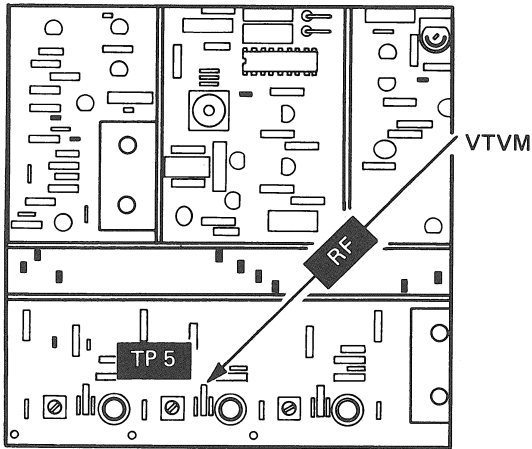

Fig. 4.7.-1

the send level of the test generator which must cause a corresponding rise of the signal as indicated on the VTVM.

4.6.8.

Note the value of the output level as read on the test generator

4.6.9.

Alter the frequency of the test generator by ± 300 kHz while increasing the output level from the test generator by 60 dB

During this test, the signal as indicated on the VTVM must remain below 1 V (static selection 60 dB)

4.7.

Alignment of RF input section

Test equipment:

Test generator, frequency 90 MHz, 0.2 mV o.c.v. no modulation

VTVM with RF probe, range to read 0.9 V

4.7.1. Tuner:

power switch depressed

4.7.2.

Checking of dial and pointer. Run pointer from one extreme end of dial to the other and check whether or not pointer travels the full length of the dial.

4.7.3.

Connect RF probe of VTVM to test point 5 (see fig. 4.7.-1)

4.7.4.

Connect test generator to the tuner's 60 ohm input (BNC/59)

4.7.5.

Turn pointer exactly to 90 MHz mark on the dial.

4.7.6.

Adjust oscillator slug L107 until a zero indication is obtained on the centre tuning meter (44). This adjustment is carried out from the soldered side of the print (see fig. 4.7.-2)

4.7.7.

Adjust coils L103/L104 and L105 of the tuned RF stages to

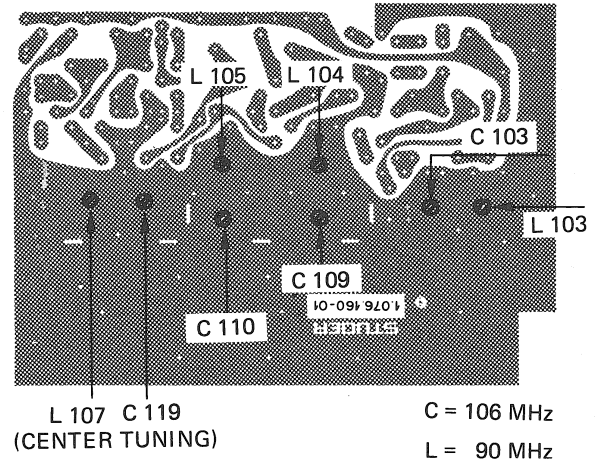

Fig. 4.7.-2

obtain a maximum reading (adjustment from soldered side, see fig. 4.7.-2)

VTVM reading for tuned RF input section: 0.9 V (+0.5/-0.2 V)

4.7.8.

Set test generator to the frequency of 106 MHz. Move pointer exactly to the 106 MHz mark on the dial.

4.7.9.

Adjust oscillator trimmer C119 to obtain zero indication on the centre tuning meter (44). (This adjustment is carried out from the soldered side, see fig. 4.7.-2)

4.7.10.

Adjust trimmer capacitors C103, C109 and C110 in the tuned RF input stages to obtain a maximum reading. (Soldered side, see fig. 4.7.-2)

VTVM reading for tuned RF input section: 0.9 V (+0.5/-0.2 V)

4.7.11.

Repeat alignment procedures 4.7.5. to 4.7.7. and 4.7.8. to 4.7.10. until no further improvement can be observed.

4.7.12

Adjust coil L106 to obtain maximum reading (at 90 MHz or 106 MHz).

(This adjustment is to be carried out from the component side of the print, see fig. 4.7.-3)

4.7.13.

Adjustment of oscillator transformer L108:

Connect RF probe of VTVM to test point 12, meter range to read 1 V (see fig. 4.7.3.)

Set pointer to the 100 MHz mark on the dial.

Adjust oscillator transformer L108 to obtain maximum reading. VTVM reading: 0.7 V (± 0.1 V)

Check to make sure that an identical signal drop of 2 dB occurs on both ends of the dial.

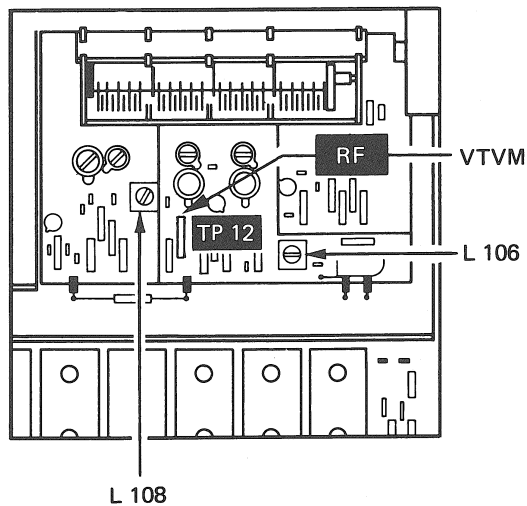

Fig. 4.7-3

4.8.

Alignment of IF amplifier

(Adjustment of transformer coupling. For alignment instructions pertaining to the IF filters, see 4.4.)

Test equipment:

Test generator, frequency 94 MHz, 2 μ V o.c.v. no modulation

VTVM with RF probe, range to read 0.5 V approx.

4.8.1. Tuner:

Power switch depressed

Move pointer to the 94 MHz mark and tune to obtain exact zero indication on the centre tuning meter (44).

4.8.2.

Connect RF probe of VTVM to test point 6 (see fig. 4.8.-1.)

4.8.3.

Connect test generator to the tuner's 60 ohm input (BNC/59)

4.8.4.

Adjust IF transformers L201 to L204 to obtain maximum reading (VTVM reading 0.5 V approx.). During this test, no limiting must take place in IC 204. (This can be checked by slightly increasing the output level of the test generator which must cause a corresponding rise of the signal as indicated on the VTVM. If limiting does occur the output level of the test generator must be reduced).

4.9.

Checking symmetry of the center tuning meter (44)

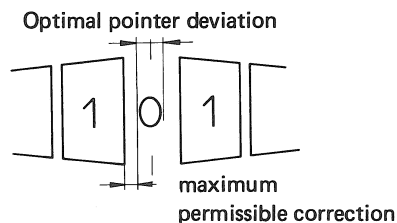

Fig. 4.9.-1

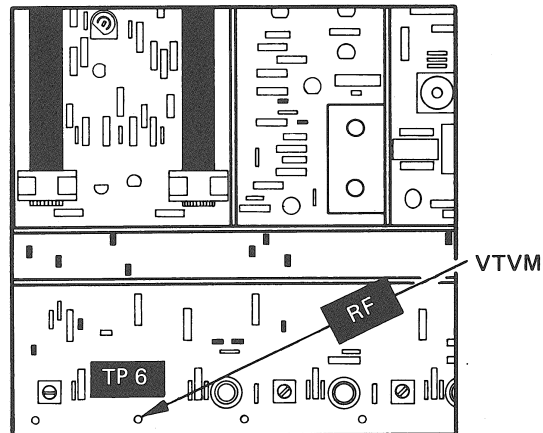

Fig. 4.8.-1

4.9.1.

Use same test generator setting as under 4.8.

4.9.2.

Turn tuning knob (40) slowly cw and ccw to detune while observing the pointer for symmetrical movement (see fig. 4.9.-1)

4.9.3.

A symmetry error not exceeding one quarter of the width of the "zero zone" is to be corrected with the secondary slug of the center tuning discriminator FT 601. See section 4.5.6. and fig. 4.5.-1.

4.10.

Checking for correct limiting (IF amplifier)

4.10.1.

Use same test generator settings as under 4.8.

4.10.2.

RF probe of VTVM remains connected to test point 6 (see section 4.8.2.)

4.10.3.

Increase output level of test generator gradually. When raising the output level above 4 μ V o.c.v., the voltage level as indicated by the VTVM must not increase any more. (Limiting taking effect).

4.11.

Sensitivity check on the center tuning (44) and the signal strength meters (43)

4.11.1.

Increase output level of the test generator to 10 mV (no modulation)

4.11.2.

When running the tuning control (40) through its full range with this signal present at the tuner's input, the following meter indications must be obtained:

Center tuning (44) from ± 2 to end of scale
Signal strength (43) from 5 to end of scale

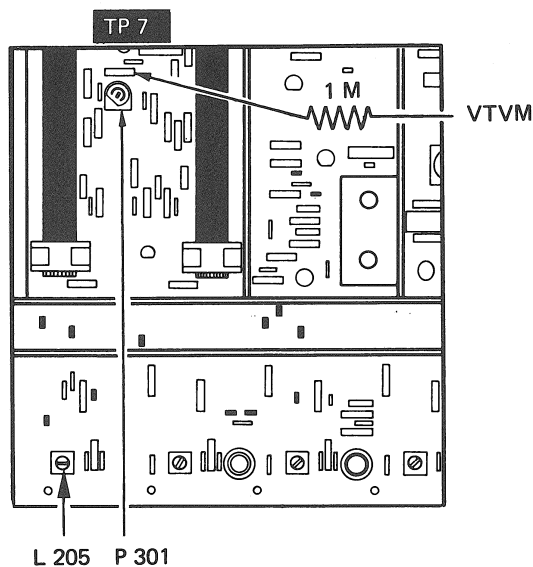

Fig. 4.12.-1

4.12. Alignment of FM demodulator

Test equipment:

Test generator frequency 94 MHz, 2 mV o.c.v. modulated with stereo modulator, deviation 75 kHz, modulating frequency 1 kHz (L = R), no pilot frequency.

1 kHz (L = R) no pilot frequency

15 kHz low pass filter (see fig. 4.2.-3)

Distortion analyser

VTVM without RF probe, DC range

4.12.1.

Power switch depressed, tuning pointer set to the 94 MHz mark; fine tune to obtain zero indication on the center tuning meter (44) set the audio output controls (55) to their maximum setting (fully clockwise)

4.12.2.

Connect 15 kHz low pass filter between the tuner's audio output (56) and distortion analyser.

4.12.3.

Measure audio output voltage with the distortion analyser. With the demodulator aligned, the audio output voltage reads: 0.5 V (± 0.1 V). Maximum permissible level difference between the two audio outputs: 0.5 dB.

4.12.4.

Calibrate distortion analyser to 100 percent, measure distortion.

Adjust IF transformer L205 to obtain minimum distortion (see fig. 4.12.-1). The maximum total harmonic distortion with the demodulator aligned must not exceed 0.3 %.

4.12.5

Connect a resistor of 1 Mohm to test point 7 (see fig.4.12.-1); connect VTVM (DC) to that resistor.

4.12.6

Adjust symmetry potentiometer P 301 (see fig. 4.12. 1) to obtain a null indication on the VTVM.

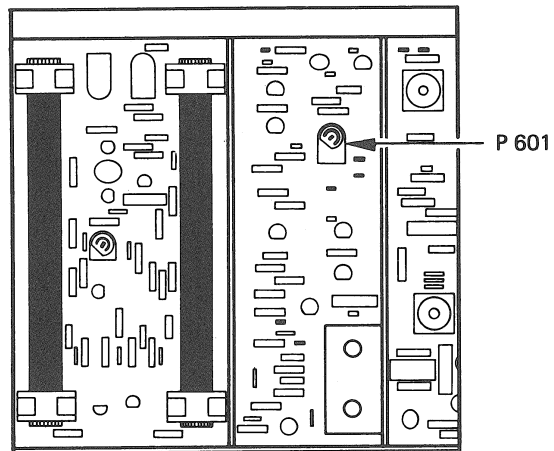

Fig. 4.13.-1

4.12.7.

Repeat alignment steps 4.12.3. to 4.12.6. until no further improvement can be reached.

4.13.

Alignment of multipath indicator

Test equipment:

Test generator, frequency 94 MHz, 2 mV o.c.v. modulated with stereo modulator, deviation 82.5 kHz, modulating frequency 1 kHz (L = R), no pilot frequency.

4.13.1. Tuner:

Power switch depressed, button MULTIPATH INDICATOR depressed (Tuners of the MK II variety are not equipped with the button MULTIPATH INDICATOR)

Set dial pointer to 94 MHz mark; fine tune to obtain zero indication on the center tuning meter (44).

4.13.2.

Adjust trim potentiometer P601 (see fig. 4.13.-1) until the light bulb MULTIPATH (42) becomes illuminated; then turn back P601 to the point where the light just goes off.

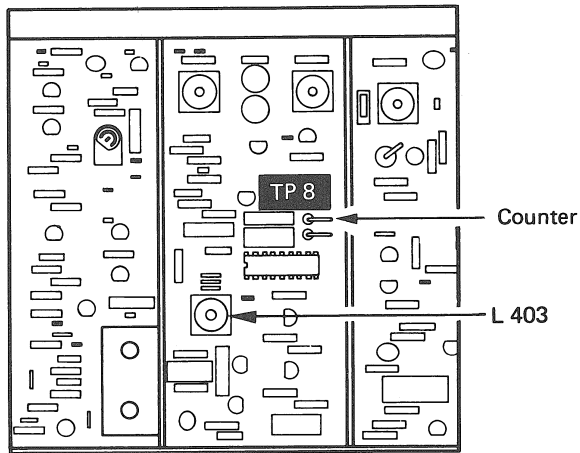

Fig. 4.14.-1

4.14.
Alignment of subcarrier oscillator (76 kHz)

Test equipment:

Test generator, frequency 94 MHz, 2 mV o.c.v., no modulation, no pilot signal

Digital counter for a frequency of 38 kHz, range approx. 1 V pp.

4.14.1. Tuner:

Power switch depressed,
set dial pointer to the 94 MHz mark; fine tune to obtain zero indication on the center tuning meter (44)

4.14.2.

Connect digital counter to test point 8 (see fig. 4.14.-1)

4.14.3.

Tune 76 kHz oscillator coil L403 (see fig. 4.14.-1). Since the squarewave frequency is being measured after the IC divider (1 : 2), this adjustment must aim for a frequency of 38 kHz \pm 25 Hz)

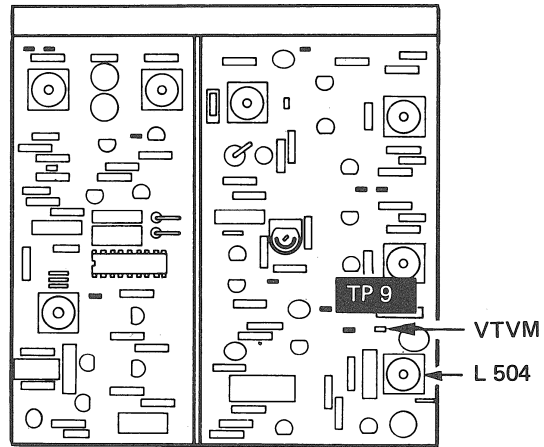

Fig. 4.15.-1

4.15.
Alignment of 19 kHz circuit

Test equipment:

Test generator, frequency 94 MHz, 2 mV o.c.v., modulated with stereo modulator 9 % pilot carrier only (6.75 kHz)
VTVM AC range to read 3.5 V (+ 0.5/-0.5 V).

4.15.1. Tuner:

Power switch depressed,
button STEREO AUTOMATIC (47) depressed
Set dial pointer to the 94 MHz mark; fine tune to obtain zero indication on the center tuning meter (44)

4.15.2.

Connect VTVM to test point 9 (see fig. 4.15.-1)

4.15.3.

Adjust L504 of the 19 kHz circuit to obtain a maximum, VTVM reading 3.5 V (+ 0.5/-0.5 V)

4.15.4.

Check to see if light bulb STEREO (45) is illuminated.

4.15.5.

Turn off pilot carrier, check STEREO indicator light is now off.

Test operation of STEREO indicator lamp which must come on again with 6 % pilot carrier (deviation 4.5 kHz)

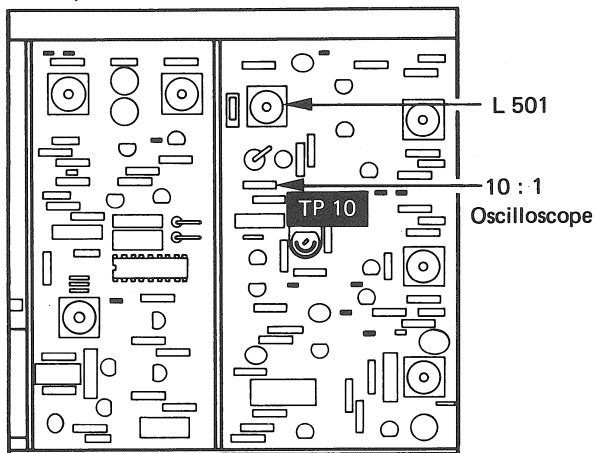

Fig. 4.16.-1

4.16.

Alignment of 38 kHz circuit

Test equipment:

Test generator, frequency 94 MHz, 2 mV o.c.v., modulated with stereo-modulator, 75 kHz deviation, modulating frequency 1 kHz, left channel only, no pilot frequency.

Cathode-Ray Oscilloscope with attenuator 10 : 1, external triggering (1 kHz), Y-amplifier, AC sensitivity 0.02 V/cm time base 50 μ sec/cm

4.16.1. Tuner:

power switch depressed

set dial pointer to 94 MHz mark; fine tune to obtain zero indication on the CENTRE TUNING meter (44).

4.16.2.

Connect attenuator to test point 10 (see fig. 4.16.-1)

4.16.3.

Tune L501 of the 38 kHz circuit (fig. 4.16.-1) to obtain a precise envelope crossover as shown in fig. 4.16.-2.

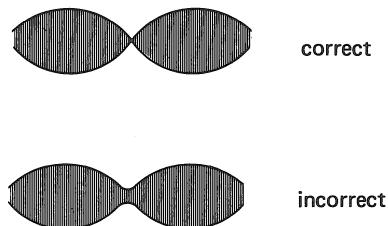

Fig. 4.16.-2

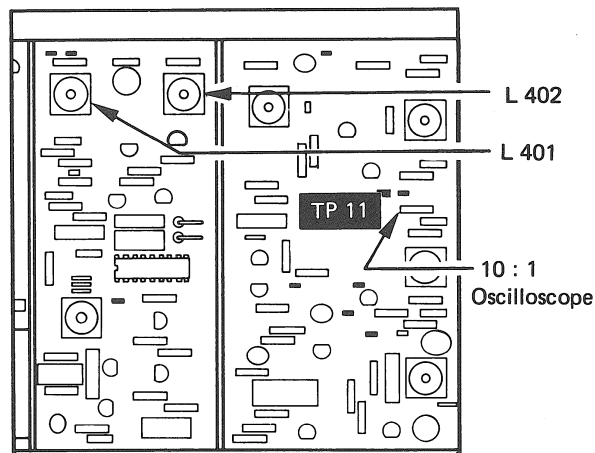

Fig. 4.17.-1

4.17.

Tuning of the 19 kHz band pass filter

Test equipment:

Test generator, frequency 94 MHz, 2 mV o.c.v., modulated with stereo-modulator, 75 kHz deviation, modulating frequency 1 kHz, left channel only, pilot carrier 9 % (6.75 kHz deviation)

Cathode-Ray Oscilloscope with attenuator 10:1, internal triggering, Y-amplifier, AC sensitivity 0.05 V/cm, timebase 2 μ sec/cm

4.17.1. Tuner:

power switch depressed

Button STEREO AUTOMATIC (47) depressed, set dial pointer to 94 MHz mark; fine tune to obtain zero indication on CENTRE TUNING meter (44).

4.17.2.

connect attenuator to test point 11 (see fig. 4.17.-1).

4.17.3.

Adjust 19 kHz bandpass L401 and L402 (see fig. 4.17.-1) until the envelope crossover coincides with the leading edge of the matrix switching frequency (see fig. 4.17.-2). Both tuning slugs should then be at approx. the same height.

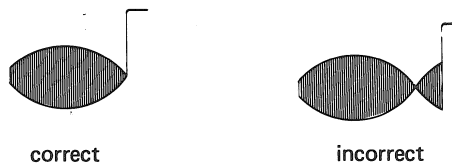

Fig. 4.17.-2

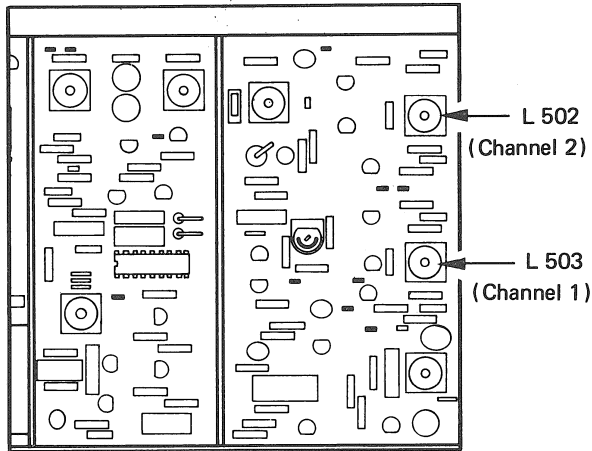

Fig. 4.18.-1

4.18. Alignment of multiplex filter

Test equipment:

Test generator, frequency 94 MHz, 2 mV o.c.v., modulated with stereo-modulator, 9 % pilot carrier only (6.75 kHz deviation)

distortion analyzer or VTVM

38 kHz band pass (see fig. 4.2.-2)

4.18.1. Tuner:

power switch depressed
button STEREO AUTOMATIC (47) depressed
Audio output controls (55) at maximum (fully cw), set dial pointer to 94 MHz mark; fine tune to obtain zero indication on CENTRE TUNING meter (44).

4.18.2.

Connect 38 kHz band pass between tuner output (56, channel 1 or channel 2 respectively) and distortion analyzer or VTVM.

4.18.3.

Adjust multiplex-filters L503 and L502 (for channels 1 and 2 respectively) to obtain a minimum of MPX-signal (less than 1.5 mV) (see fig. 4.18.-1).

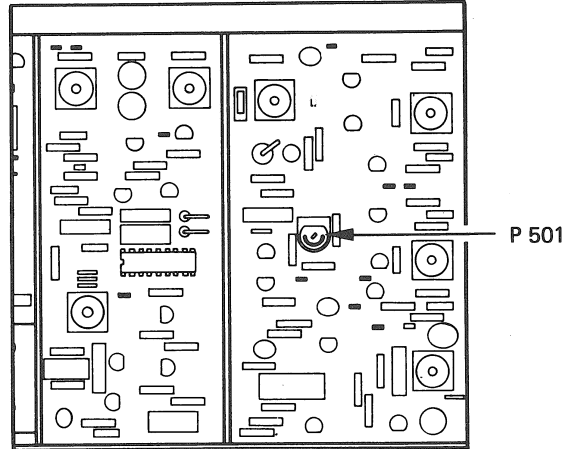

Fig. 4.19.-1

4.19. Adjustment for minimum stereo crosstalk

Test equipment:

Test generator, frequency 94 MHz, 2 mV o.c.v., modulated with stereo-modulator, deviation 40 kHz, modulating frequency 1 kHz (L = R), pilot carrier 9 % (deviation 6.75 kHz)

distortion analyzer or VTVM

15 kHz low pass filter (see fig. 4.2.-3)

4.19.1. Tuner:

Power switch depressed
Button STEREO AUTOMATIC (47) depressed
Audio output controls (55) at maximum (fully cw), set dial pointer to 94 MHz mark; fine tune to obtain zero indication on the CENTRE TUNING meter (44).

4.19.2.

Connect 15 kHz low-pass between tuner output (56, channel 1 or channel 2 respectively) and distortion analyzer or VTVM.

4.19.3.

Calibrate distortion analyzer (or VTVM) for 0 dB reference deflection.

4.19.4.

Turn off modulation on channel 1; measure crosstalk on channel 2 and adjust with trimpot P501 for minimum reading (see fig. 4.19.-1)

The crosstalk figure must exceed 40 dB.

4.19.5.

Turn on modulation on channel 1 and turn off modulation on channel 2; measure crosstalk from channel 1 (value obtained must be better than 40 dB).

4.20.

Checking of automatic mono-stereo changeover
(level-dependent)

Test equipment:

Test generator: frequency 94 MHz o.c.v. variable from 2 to 20 μ V, modulated with stereo modulator, deviation 40 kHz, modulating frequency 1 kHz (L = R), pilot carrier 9% (deviation 6.75 kHz).

4.20.1. Tune :

Power switch depressed

Buttons STEREO AUTOMATIC (47) and MUTING ON (49) depressed, set dial pointer to 94 MHz mark; fine tune to obtain zero indication on the CENTRE TUNING meter (44).

4.20.2.

Reduce generator output level gradually from 20 μ V o.c.v. while observing the STEREO (45) indicator light, and also monitoring the audio output.

Check generator level at which the STEREO indicator light goes off and the audio output disappears.

The circuits work satisfactorily when switching occurs while lowering the generator level down through 15 μ V o.c.v.

4.20.3.

Depress button TRIGGER LEVEL VAR (48) and raise send level to 100 μ V o.c.v. Slowly rotate the TRIGGER LEVEL (39) control until reception again returns to mono, or until the audio output ceases.

The automatic changeover circuit works satisfactorily when triggering occurs at position 5 of the control.

4.21.

Checking range of output potmeters

Test equipment:

Test generator, frequency 94 MHz, 2 mV o.c.v., modulated with stereo-modulator, 40 kHz deviation, modulating frequency 1 kHz (L = R), pilot carrier 9% (6.75 kHz deviation).

15 kHz low-pass filter (see fig 4.2-3).

4.21.1. Tuner:

Power switch depressed

Button STEREO AUTOMATIC (47) depressed, set dial pointer to 94 MHz mark; fine tune to obtain zero indication on CENTRE TUNING meter (44).

4.21.2.

Connect 15 kHz low-pass filter between tuner output (56, channel I or channel II respectively) and distortion analyzer or audio millivoltmeter.

4.21.3.

Calibrate distortion analyzer (or millivoltmeter) to obtain reference deflection.

4.21.4.

Turn output-potmeters (56) of channel I and channel II fully counter clock wise and measure output level.

Both controls are functioning properly when attenuating the signal by 26 dB.

5 INSTRUCTIONS FOR MEASURING THE MOST IMPORTANT PERFORMANCE DATA

For any of the following measurements all metal shields must be installed on their proper places. (Shield on rf-input section, plus the large cover plates on top and bottom of the tuner).

The output voltage of the test generator is stated in open circuit voltage (o.c.v.). If the internal (source) impedance of the test generator is 60 ohms, then the voltage developed across the tuners 60 ohm input will be exactly one half of the generators o.c.v. (see fig. 4.2.-4).

Test generators which are calibrated to indicate the signal voltage across the nominal terminating impedance have to be set to one half of the prescribed o.c.v. value.

The predominantly used test frequency of 94 MHz is to be taken as a guide only. Prior to starting any alignment procedures, it should be checked whether or not that frequency does not produce an interference with a neighbouring FM transmitter. (This should be checked with the test generator connected to the tuner, but with the signal turned off). If an FM broadcast can still be received, the test frequency of 94 MHz (or 87.5 MHz) should be altered slightly.

For all measurements:

Connect 15 kHz low-pass filter between tuner output (56, channel I or channel II respectively) and distortion analyzer or audio-millivoltmeter.

5.1. Input sensitivity

Test equipment:

Test generator, frequency 94 MHz, 2 μ V o.c.v., modulated with stereo modulator, 15 kHz deviation, modulating frequency 1 kHz (L = R) pilot carrier 9% (6.75 kHz deviation).

Distortion analyzer or audio millivoltmeter.

5.1.1. Tuner:

Power switch depressed

Button STEREO AUTOMATIC (47) depressed. Adjust generator frequency until a zero reading is obtained on the CENTRE TUNING meter (44) (approx. 94 MHz).

5.1.2.

Calibrate distortion analyzer (or audio millivoltmeter) to obtain a reference reading.

5.1.3.

Turn off modulation to measure signal to noise ratio. The tuners sensitivity is within specifications when obtaining a ratio of 30 dB in the mono-mode.

(The input signal of 2 μ V o.c.v. must not trigger the automatic mono-stereo changeover).

5.1.4.

Raise o.c.v. level from the test generator to 20 μ V o.c.v. and measure signal to noise ratio. The tuners sensitivity is within specifications if a ratio of 30 dB or more is obtained in the stereo-mode. (The input signal of 20 μ V o.c.v. must be sufficient to effect positive triggering of the automatic mono-stereo changeover)

5.2.

Measuring static selectivity

See 4.6.6. to 4.6.7.

5.3.

Image response

Test equipment:

Signal generator, frequency 87.5 MHz, 2 μ V o.c.v. modulated with stereo modulator, 15 kHz deviation, modulating frequency 1 kHz, no pilot frequency.

Distortion analyzer or audio millivoltmeter.

5.3.1. Tuner:

Power switch depressed

Set dial pointer to 87.5 MHz mark (left hand stop), fine tune to obtain zero indication on the CENTRE TUNING meter (44).

5.3.2.

Calibrate distortion analyzer or millivoltmeter to obtain a reference reading.

5.3.3.

Turn off modulation, measure noise voltage and keep a note of the reading obtained (ratio must exceed 30 dB).

5.3.4.

Adjust frequency and signal generator to 109 MHz (that is the previous test frequency of 87.5 MHz plus twice the IF, which equals 21.4 MHz).

Increase output level to 100 mV o.c.v., fine adjust frequency to obtain zero reading on the CENTRE TUNING meter (44).

5.3.5.

Lower output level until a noise voltage (as noted under 5.3.3.) is reached (better than 30 dB).

Image response performance is within specifications when this noise value is reached with an output level of 12 mV o.c.v. or higher. (Image response 76 dB).

5.4.

Spurious response

Test equipment:

Signal generator, frequency 94 MHz, 2 μ V o.c.v., modulated with stereo modulator, 15 kHz deviation, modulating frequency 1 kHz, no pilot frequency.
Distortion analyzer (or audio millivoltmeter).

5.4.1. Tuner:

Power switch depressed,

Adjust output frequency on generator to obtain zero reading on CENTRE TUNING meter (44) (approx. 94 MHz).

5.4.2.

Calibrate distortion analyzer or millivoltmeter to obtain a reference reading.

5.4.3.

Turn off modulation, measure noise voltage and keep a note of the reading obtained (ratio must exceed 30 dB).

5.4.4.

Adjust output frequency on generator to 88.65 MHz (that is the previous test frequency of 94 MHz minus 5.35 MHz), raise output level to 100 mV o.c.v.

fine adjust frequency to obtain zero reading on CENTRE TUNING meter (44).

5.4.5.

Reduce output level until a noise voltage as noted under 5.4.3. is reached (better than 30 dB). The tuners spurious response is within specifications when this noise value is reached with an output level of 60 mV o.c.v. or higher (spurious response 90 dB).

5.5.

Distortion

Test equipment:

Signal generator, frequency 94 MHz 2 mV o.c.v., modulated with stereo modulator, 40 kHz deviation, modulating frequency 1 kHz (L = R), pilot frequency 9 % (6.75 kHz deviation).

Distortion analyzer.

5.5.1. Tuner:

Power switch depressed,
adjust output frequency on signal generator to obtain zero reading on CENTRE TUNING meter (44) (approx. 94 MHz)

5.5.2.

Calibrate distortion analyzer to obtain a reference reading.

5.5.3.

Measure distortion product.

In the mono-mode (button STEREO AUTOMATIC (47) released) total harmonic distortion must not exceed 0.2 %.

5.6.

Signal to noise ratio

Test equipment:

Signal generator, frequency 94 MHz, 2 mV o.c.v. modulated with stereo modulator, 75 kHz deviation, modulating frequency 1 kHz, no pilot frequency.

Distortion analyzer (or audio millivoltmeter).

5.6.1. Tuner:

Power switch depressed,
Adjust frequency on generator to obtain zero indication on CENTRE TUNING meter (44) (approx. 94 MHz).

5.6.2.

Calibrate distortion analyzer (or millivoltmeter) to obtain a reference reading.

5.6.3.

Turn off modulation, read signal to noise ratio (> 70 dB).

5.7.

Stereo separation (crosstalk)

Test equipment:

Signal generator, frequency 94 MHz, 2 mV o.c.v. modulated with stereo modulator, 40 kHz deviation, modulating frequency 1 kHz (L = R) pilot signal 9 % (6.75 kHz deviation).
Distortion analyzer (or audio millivoltmeter).

5.7.1. Tuner:

Power switch depressed,
adjust frequency on generator to obtain zero indication on CENTRE TUNING meter (44) (approx. 94 MHz).

5.7.2.

Calibrate distortion analyzer (or millivoltmeter) to obtain a reference reading.

5.7.3.

Turn off modulation of left channel (or right channel respectively), take reading of signal crosstalk from other channel. The crosstalk figure must be not less than 40 dB.

5.8.

Frequency response

Test equipment:

Signal generator, frequency 94 MHz, 2 mV o.c.v., modulated with stereo-modulator, 40 kHz deviation, modulating frequency 1 kHz, no pilot signal.

Distortion analyzer (or audio millivoltmeter).

5.8.1. Tuner:

Power switch depressed,

adjust frequency on generator to obtain zero indication on CENTRE TUNING meter (44) (approx. 94 MHz).

5.8.2.

Adjust distortion analyzer (or millivoltmeter) to obtain a reference reading.

5.8.3.

Change modulating frequency to

30 Hz output deviation: 0 dB

15 kHz output deviation: deemphasis 50 μ s : - 13.5 dB

deemphasis 75 μ s : - 17 dB

6. TECHNICAL DATA

Tuning range: 87.5 ... 108 MHz

Sensitivity: mono 1 μ V
stereo 10 μ V

measured at the 60 ohm input for 30 dB S/N ratio at a deviation of 15 kHz.

Static selectivity: 60 dB at 300 kHz separation

Spurious response: 90 dB

Image rejection: 76 dB

IF rejection: 100 dB

Bandwidths: IF-filter 130 kHz, IF-amplifier and demodulator 5 MHz

Capture ratio: 1 dB measured at 1 mV antenna signal and a deviation of 40 kHz.

AM rejection: 54 dB referenced to 22.5 kHz deviation, 30 % AM (400 Hz and 1 mV antenna input).

Pulse noise rejection: 40 dB, peak noise ratio referenced to 75 kHz deviation, measured with a 100 μ V input signal and 1 mV per 100 kHz pulse noise voltage (50 Hz).

Distortion: 0.2 % at 1 kHz and 40 kHz deviation (mono or stereo L = R).

Signal to noise ratio: 70 dB at 75 kHz deviation and 1 mV antenna input.

SCA rejection: 80 dB at 67 kHz.

Pilot signal suppression: 40 dB at 19 kHz referenced to 75 kHz deviation

Subcarrier suppression: 50 dB at 38 kHz referenced to 75 kHz deviation.

Frequency response: 30 Hz ... 15 kHz - 1 dB measured from antenna input to audio output.

Deemphasis: 50 μ sec or 75 μ sec.

Audio output: 1 volt at 75 kHz deviation.

Semiconductor complement: 3 MOS-FET's, 40 silicon transistors, 6 IC's, 26 diodes, 2 silicon rectifiers.

Power requirement: voltage selector for 110 V to 250 V, 50 to 60 Hz operation, consumption 20 watts.

Dimensions: 16 3/8 x 6 5/16 x 9 5/8 inches.

7. SCHEMATICS

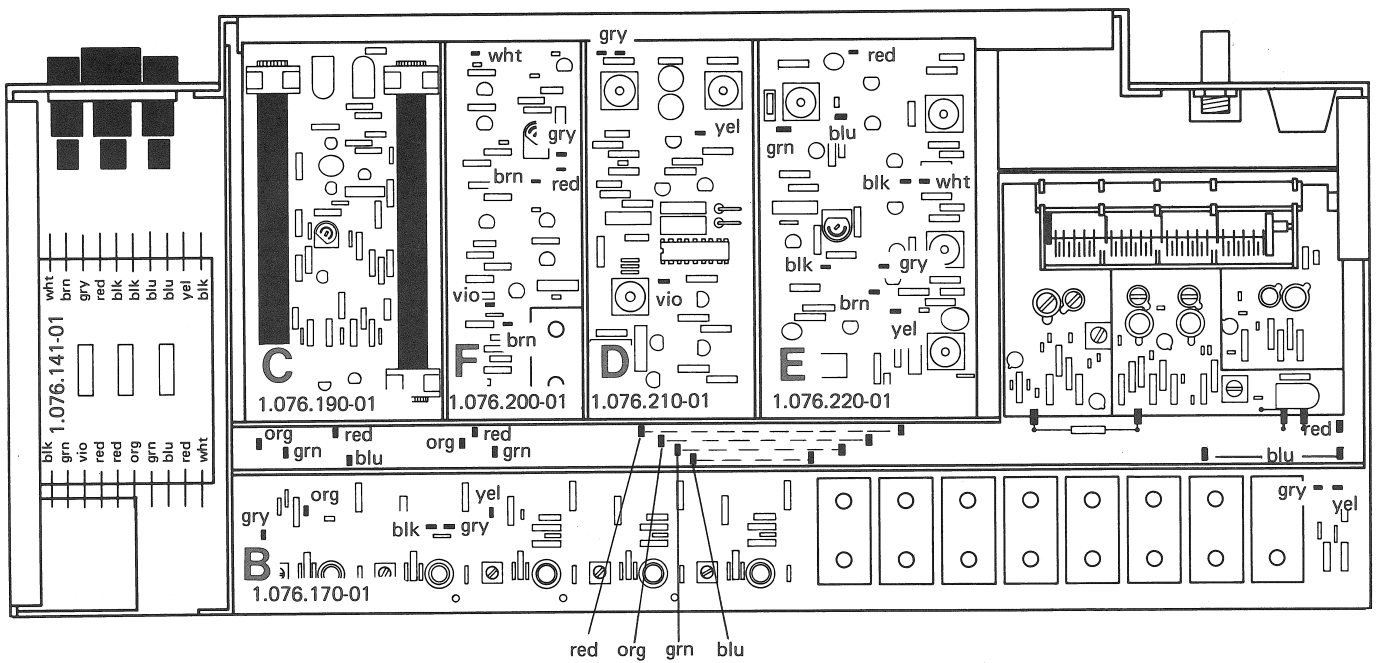

Drahtfarben der Steckverbindungen
 Couleur des fils de liaison enfichables
 Wire colours of plugable connections

REVOX A76

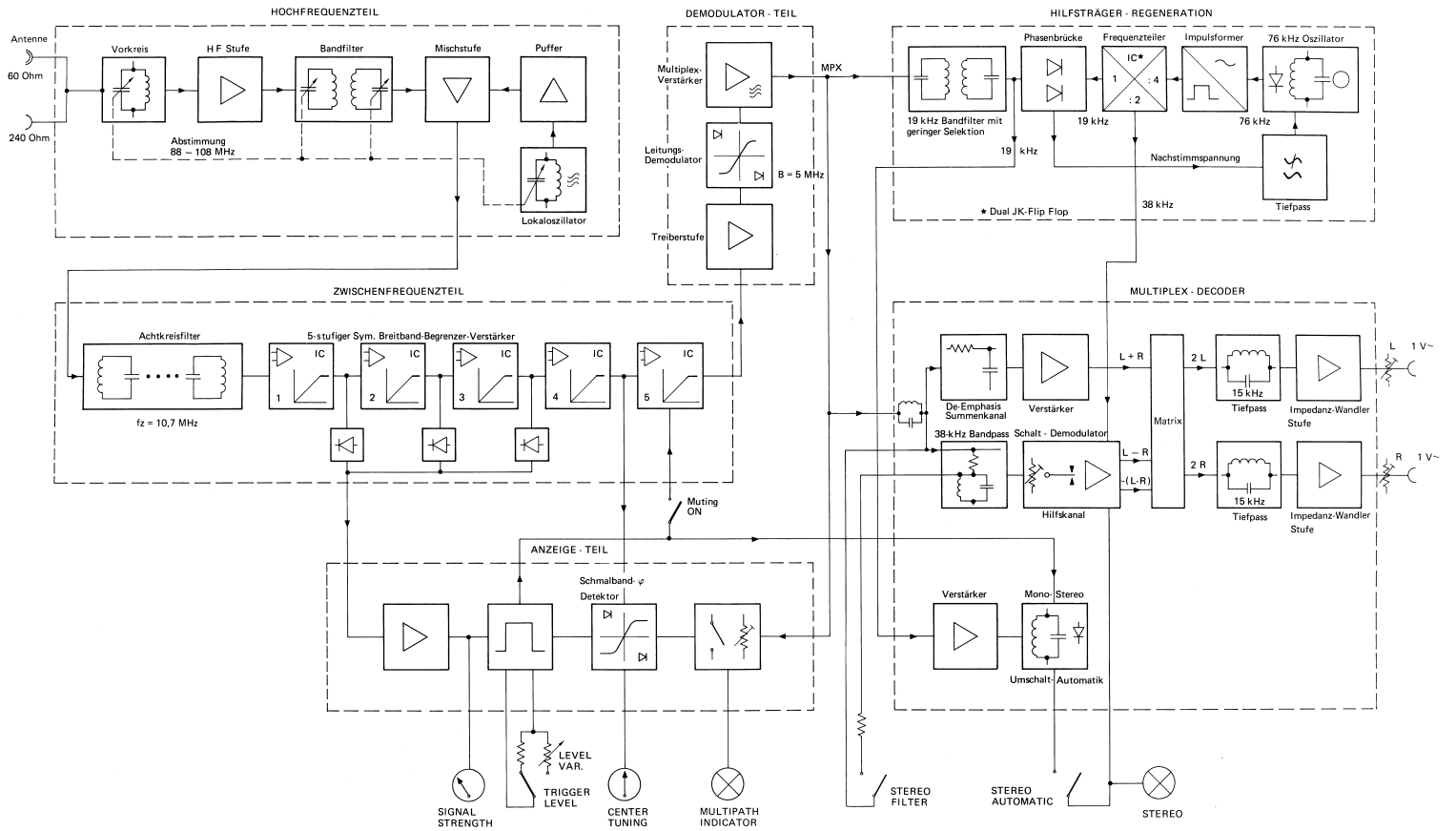

BLOCK-DIAGRAM
 BLOCK DIAGRAM
 SCHEMA FONCTIONNEL

REVOX A76

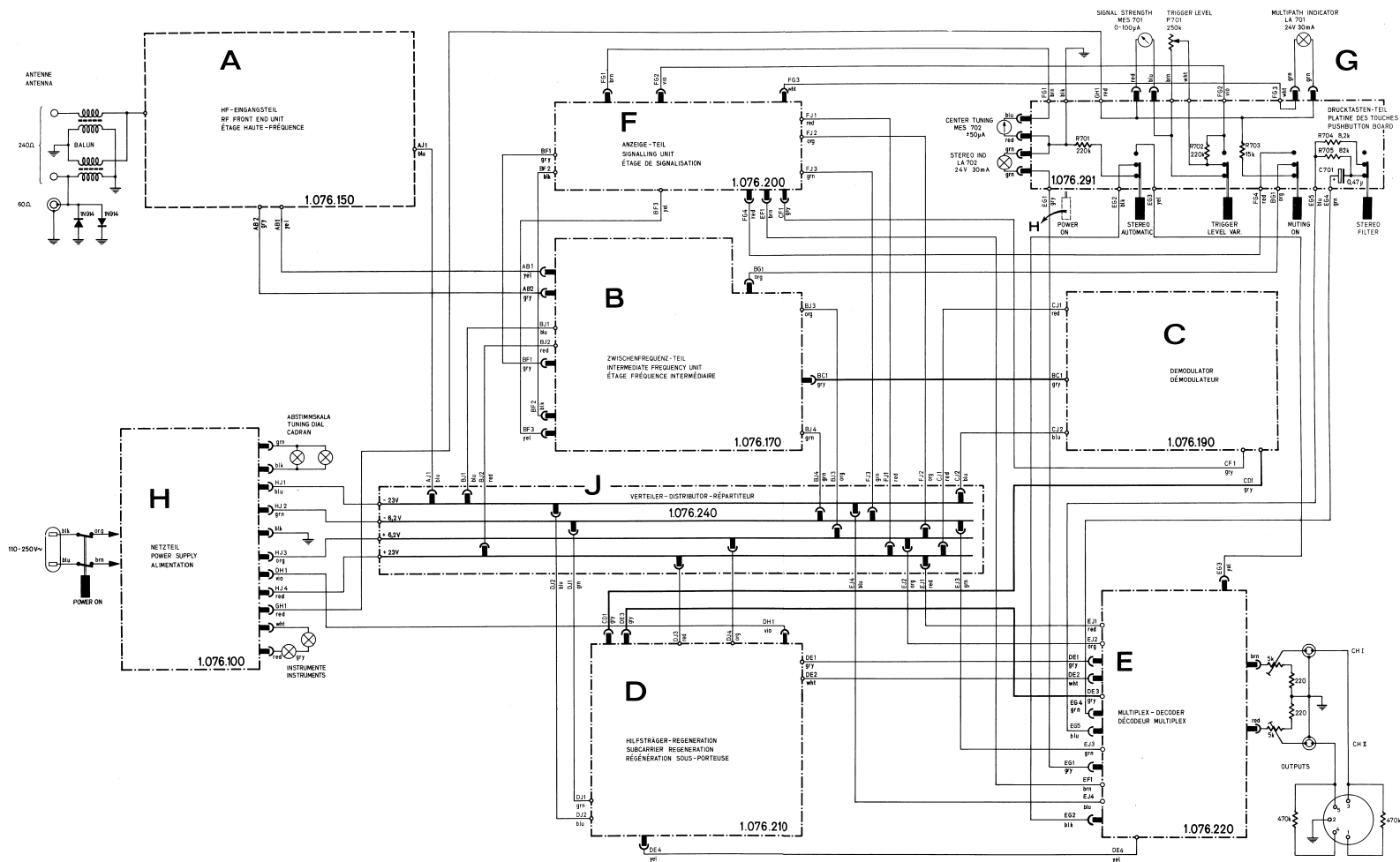

VERBINDUNGSSCHALTBILD
 CONNECTION DIAGRAM
 SCHEMA D' INTERCONNEXION

REVOX A76

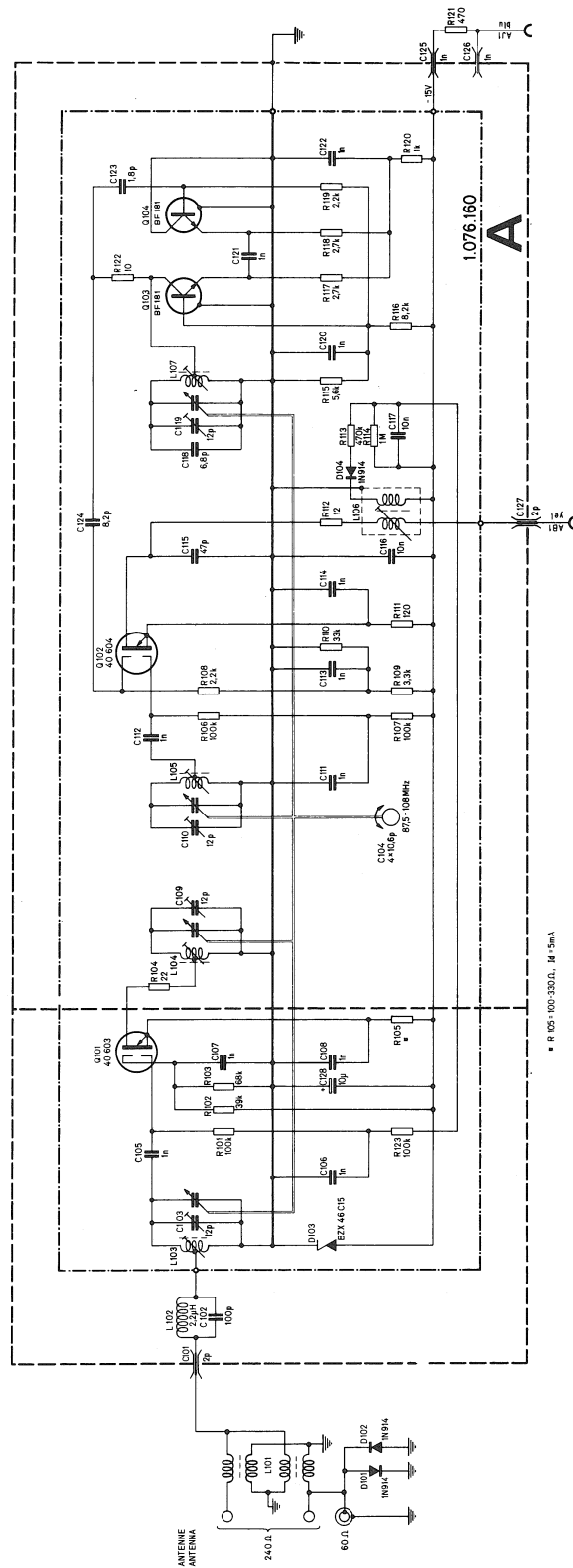

HF-EINGANGSTEIL
 RF-FRONT END UNIT
 ÉTAGE HAUTE-FRÉQUENCE

bis Fabr. Nr. 3175
 up to ser. nr. 3175
 jusqu'au no. 3175

REVOX A76

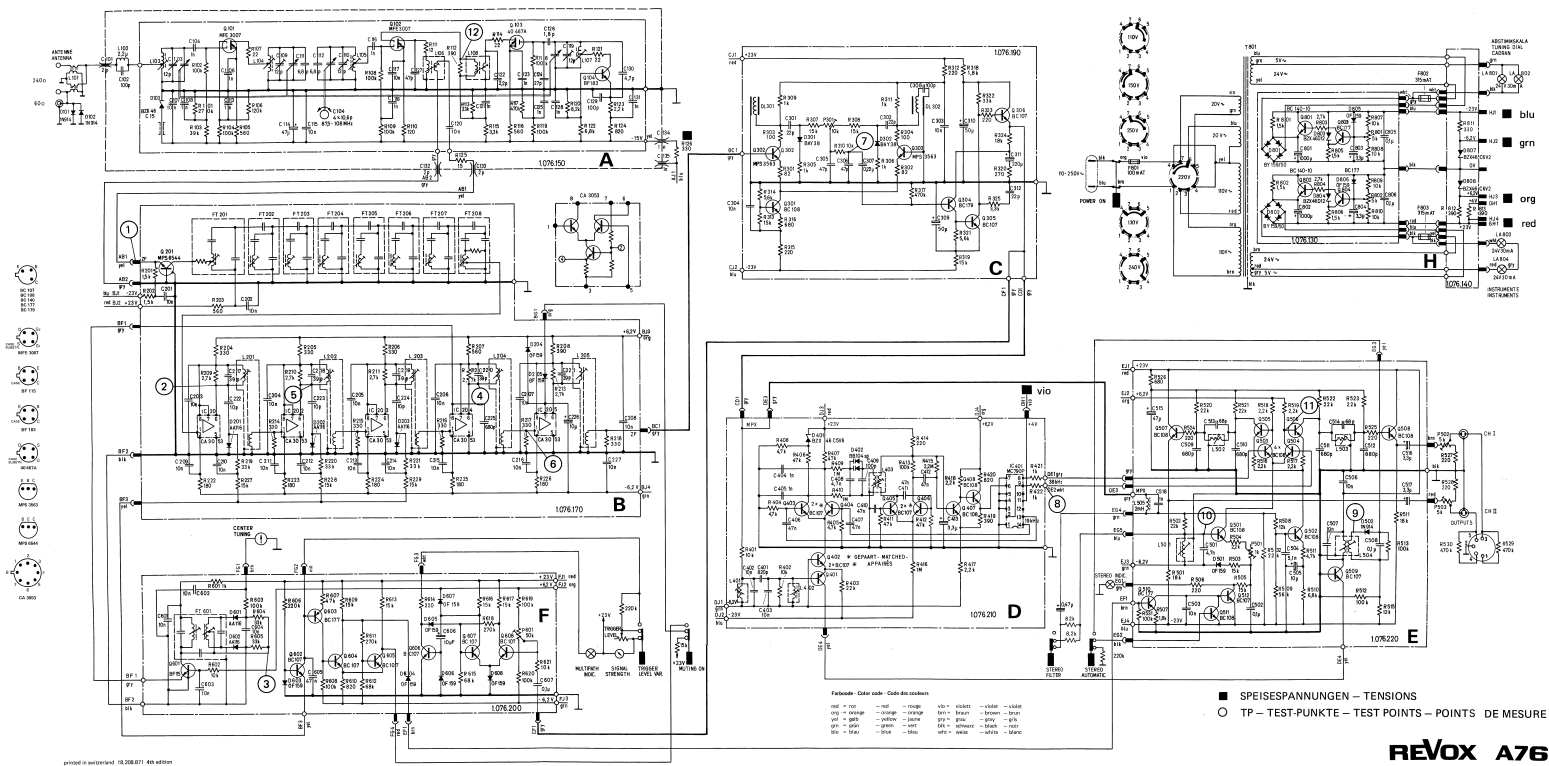

printed in Switzerland 18.206.071 4th edition

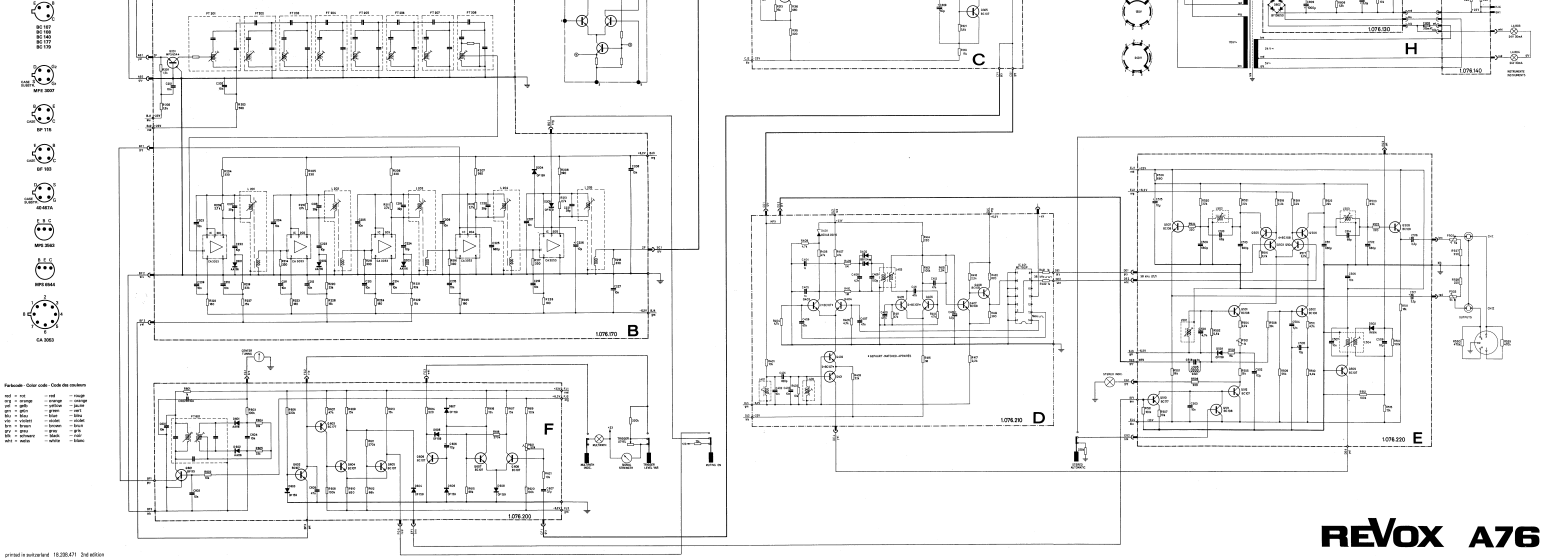

REVVOX A76

