



SERVICE MANUAL

SERVICE MANUAL

MODEL: T973

SERVICE MANUAL

T973 MK II-B C/AH

SEVEN CHANNEL AMPLIFIER

SEVEN CHANNEL AMPLIFIER

**T973 MK II-B
C/AH**



**T973 MK II-B
C/AH**
SEVEN CHANNEL AMPLIFIER

© NAD 2006

**NAD ELECTRONICS INTERNATIONAL
TORONTO**

CONTENTS

FRONT PANEL/REAR PANEL VIEW.....	3
SPECIFICATIONS.....	4
IMPORTANT REPLACEMENT MARK.....	5-6
ALIGNMENT PROCEDURE/ALIGNMENT POINTS.....	7-8
WIRING DIAGRAM.....	9
SCHEMATIC DIAGRAM.....	10-17
PCB LAYOUT.....	18-26
ELECTRICAL PARTS LIST.....	27-39
EXPLODED VIEW.....	40
EXPLODED VIEW PARTS LIST.....	41
IMPORTANT REPLACEMENT P/N LIST (PARTS SUBSTITUTION).....	42
PACKING DIAGRAM.....	43

SERVICE SAFETY PRECAUTIONS

1. Replacing the Fuses

CAUTION: FOR CONTINUED PROTECTION AGAINST THE RISK OF FIRE REPLACE ONLY WITH SAME TYPE OF FUSE.

REFERENCE NO.	PART NUMBER	DESCRIPTION
Rear Panel		
AH ▲	20-11203-10	MDA T20AL/250V
C ▲	20-12103-20	MDA T10AL/250V
AMP Board		
F101/F102 ▲	20-12632-00	T6.3AL/250V
PSU Board		
F201-F204 ▲	20-12162-01	T1.6AL/250V

NOTE:

*AH : North American version only

*C : European version only

2. Safety-check out (North American model only)

Before returning the product to the customer, make leakage current or resistance measurements to determine that exposed parts are acceptably insulated from the supply circuit.

Parts marked with the symbol ▲ are critical with regard to the risk of fire and electric shock. Replace only parts recommended by the manufacturer.

FRONT PANEL / REAR PANEL VIEW

FRONT PANEL CONTROLS

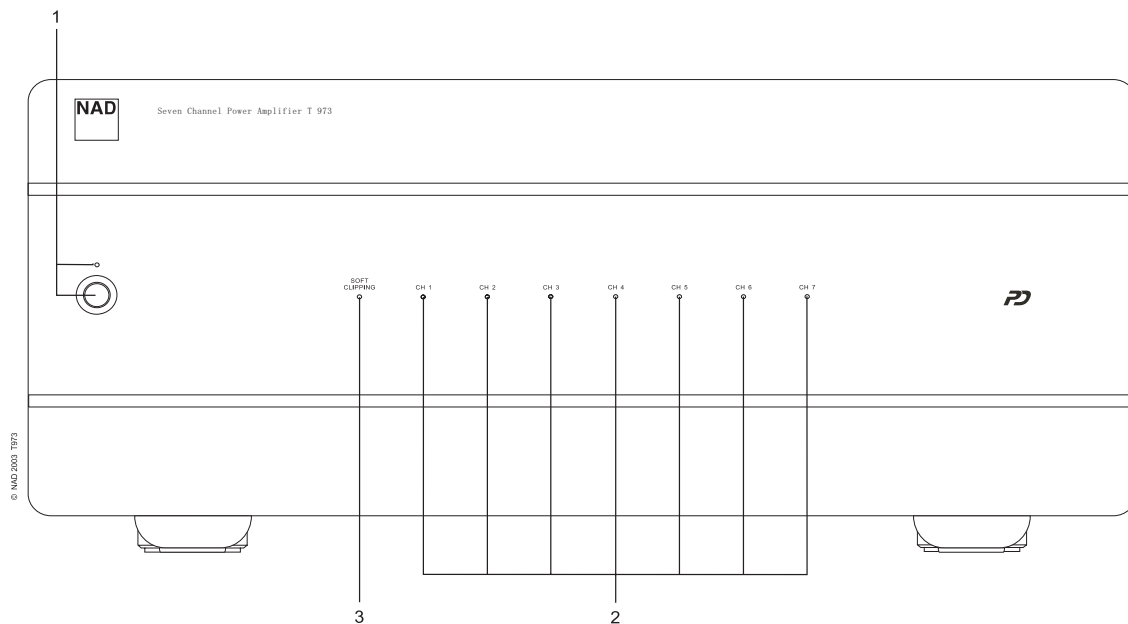

- 1. POWER SWITCH
- 2. POWER INDICATOR
- 3. SOFT CLIPPING INDICATOR

REAR PANEL CONTROLS

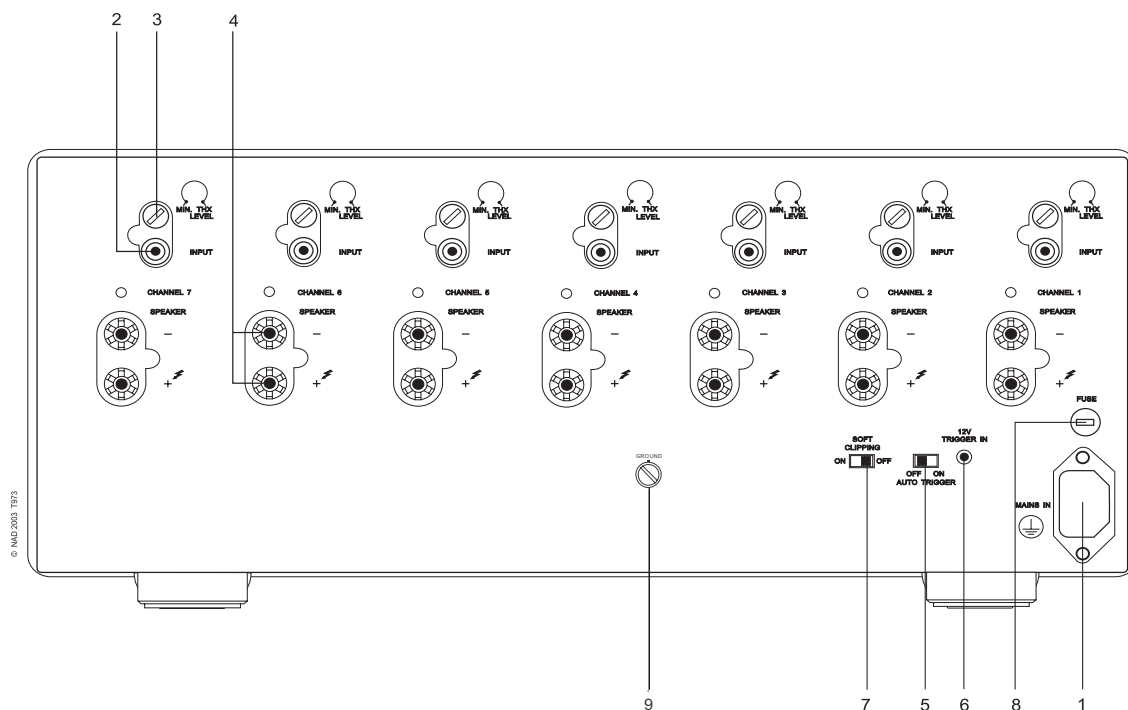

- 1. AC INLET
- 2. INPUT JACK
- 3. LEVEL CONTROL
- 4. SPEAKER TERMINALS
- 5. AUTO TRIGGER SWITCH
- 6. 12V TRIGGER INPUT
- 7. SOFT CLIPPING SWITCH
- 8. MAINS FUSE
- 9. GROUND TERMINAL

SPECIFICATIONS

CONTINUOUS AVERAGE POWER OUTPUT INTO 8 OHMS OR 4 OHMS (Min. power per channel, 20 Hz – 20 kHz, both channels driven, with no more than rated distortion)	≥120 W (20.8 dBW)
Rated Distortion (THD 20 Hz – 20 kHz)	≤0.03%
Clipping power (maximum continuous power per channel).	≥150 W(21.8 dBW)
IHF dynamic power (Maximum short term power per channel)	
8 ohms:	≥200 W (23.0 dBW)
4 ohms:	≥360 W (25.6 dBW)
2 ohms:	≥420 W (26.2 dBW)
Damping factor (ref. 8 ohms 50Hz)	>200
Input Impedance	R = 1 Mohms C = 180 pF
Input sensitivity (for rated output into 8 ohms)	1100mV+/-50mV
Voltage gain	29 dB
Frequency response 20 Hz – 20 kHz	±0.2 dB - 3dB at 3 Hz/100 kHz
Signal / Noise ratio, A-weighted	>96 dB ref. 1 W >116 dB ref. 120W

DIMENSIONS AND WEIGHTS

Net Weight	31 kg (68.0 lb)
Shipping Weight	33 kg (72 lb)
Dimension (W×H×D)	435 × 180 × 450mm

IMPORTANT REPLACEMENT MODULE PROCEDURE

Many of the PCB modules of T975 and T973MKII-B are similar. NAD will supply T975 modules for the various versions of T973. There are detail service instructions for the T973, T973MKII-A, and T973MKII-B service personnel should adhere to in the following two pages:

1) T973 and T973MKII-A PowerAMP module

The PowerAMP module (AH P/N:01-97501-10 and C P/N:01-97501-20) of the T975 can be used as direct replacements for the PowerAMP module of the T973 and the T973MKII-A.

When replacing the T973 PowerAMP module with the T975 PowerAMP module, one must replace all the T973 PowerAMP modules with T975 PowerAMP modules.

There will only be one version of PowerAMP module available for repair; the T975 PowerAMP module. **DO NOT** mix T973, T973MKII-A and T975 PowerAMP modules.

IMPORTANT NOTES:

Check that the Trigger board is the newer type; R401, R402, R403, R404 are 24kOhm resistors, and D401, D402, D403, D404 are 24V Zener Diodes. When ordering the T975 PowerAMP modules, order a new Trigger board as well.

The idle current adjustment is now changed; use the adjustment procedure from the T975 service manual for the T975 PowerAMP module.

2) T973MKII-B PowerAMP module

The PowerAMP module (AH P/N:01-97501-10 and C P/N:01-97501-20) of the T975 can be used as direct replacements for the PowerAMP module of the T973MKII-B.

3) T973 and T973MKII-A Power supply board

The Power supply board (P/N:01-97502-00) of the T975 **cannot** be used as direct replacement Power supply board of the T973 and T973MKII-A. The Power supply board (P/N: 01-97502-99) will be the replacement part for the T973 and the T973MKII-A Power supply board.

The T975 Power supply board has the addition of D227, D228, D229, which will be to be removed. Furthermore, the cable of P207A being a 6-wire cable will be replaced with a new 4-wire cable with its part number being 14-97506-01.

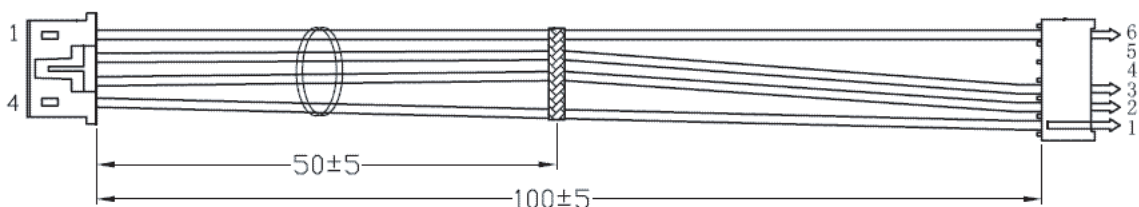

14-97506-01

4) T973MKII-B Power supply board

The Power supply board (P/N:01-97502-00) of the T975 can be used as a direct replacement for the Power supply board of the T973MKII-B.

5) T973, T973MKII-A, and T973MKII-B Display board (Including Power LED board)

The Display board (P/N:01-97503-00) of the T975 **cannot** be used as a direct replacement Display board of the T973MKII-B. The Display board (PN: 01-97503-99) will be the replacement part for the T973MKII-B Display board. The difference between the T975 Display board and the T973 Display board is the double colour LED. The LED is Red and Blue (P/N:33-50565-00) for the T975, and Red and Green (P/N:33-50525-02) for the T973, T973MKII-A, and T973MKII-B.

The Power LED board (P/N:01-97507-99) should be replaced with display board (P/N:01-97503-99). The difference between the T975 Display board and Power LED replacement is the double colour LED. The LED is Amber and Blue (P/N:33-50565-01) for the T975, and Amber and Green (P/N:33-50525-98) for the T973, T973MKII-A, and T973MKII-B.

6) T973 and T973MKII-A Standby board

The Standby board (AH P/N:01-97505-10, C P/N:01-97505-20) of T975 **cannot** be used as direct replacement Standby board of T973 and T973MKII-A. The Standby board (AH P/N: 01-97505-98 and C P/N: 01-97505-99) will be the replacement part for the T973 and T973MKII-A Standby board.

7) T973MKII-B Standby board

The Standby board (AH P/N:01-97505-10, C P/N:01-97505-20) of the T975 can be used as a direct replacement for the Standby board of the T973MKII-B.

8) T973, T973MKII-A, and T973MKII-B Trigger board

The Trigger board (P/N:01-97504-00) of the T975 can be used as a direct replacement trigger board for the T973MKII-A and T973MKII-B.

9) T973, T973MKII-A, and T973MKII-B Connection board

The Connection board (P/N:01-97506-00) of the T975 can be used as a direct replacement Connection board for the T973, T973MKII-A, and T973MKII-B.

10) T973, T973MKII-A, and T973MKII-B Power switch board

The Power switch board (P/N: 01-97508-00) of the T975 can be used as a direct replacement Power switch board for the T973, T973MKII-A, and T973MKII-B.

11) T973MKII-B TP board

The TP board (P/N: 01-97509-00) of the T975 can be used as a direct replacement TP board for the T973MKII-B.

ALIGNMENT PROCEDURE

A. THERMAL SENSE ADJUSTMENT

This adjustment should be always done when the T973MKII-B is cool condition. (That means the temperature inside the unit should be almost same as the ambient temperature. Connector P208B that connects the transformer and power board should be removed to avoid that the Idling current heats up the unit excessively) At ambient temperature of 25 C degrees and when the unit is just turned on (still in cool condition), adjust the pot RV103 (as marked as “Thermal Sense ADJ” in below drawing) for a voltage between the THERMAL TEST POINT and AGND to be 750mV \pm 10mV. If the ambient temperature is different, the voltage setting should be changed by 20mV per degree difference. So at 20C degrees, the voltage should be 850mV \pm 10mV; and at 30C degrees, the voltage should be 650mV \pm 10mV, etc.

B. DC OFFSET VOLTAGE

The DC OFFSET between OFFSET Test Point and AGND must be within 0 \pm 3mV. If it's found to be out of this range, change the TL084BCD to one selected for low offset voltage to meet the requirement.

C. IDLING CURRENT: T973, T973MKII-A, and T973MKII-B PowerAMP Module

The idling current in the output stage of the poweramp should be set to 40mA \pm 10mA per pnp-npn transistor pair. (This means the mid point voltage is 8mV with down limit of 7mV and up limit of 9mV). The alignment procedure is: At first, adjust RV102 (Marked as “Idling Current ADJ” in the drawing below) for a voltage of 8mV \pm 1mV between Test point 1 and 2. Then preheat the unit for 5 minutes, let idling current settled and then readjust to 8mV \pm 1mV.

Pls note:

1. The idling current must be adjusted when all modules are assembled into the unit.
2. Though the idling current is set as 8mV \pm 1mV during the adjustment, due to the influence of varied ambient temperature and mains voltage etc., the idling current will drift after some time. During the normal checking of idling current in the service field, it's acceptable as long as the voltage is in the range of 7mV—9mV.

C. IDLING CURRENT: T975 PowerAMP Module

The idling current in the output stage of the poweramp should be set to 40mA \pm 10mA per pnp-npn transistor pair (This means the mid point voltage is 17.6mV with down limit of 13.2mV and up limit of 22mV). The alignment procedure is: At first, adjust RV102 (Marked as “Idling Current ADJ” in the drawing below) for a voltage of 17.6mV \pm 1mV between Test point 1 and 2. Then preheat the unit for 5 minutes, let idling current settled and then readjust to 17.6mV \pm 1mV.

Pls note:

1. The idling current must be adjusted when all modules are assembled into the unit.
2. Though the idling current is set as 17.6mV \pm 1mV during the adjustment, due to the influence of varied ambient temperature and mains voltage etc., the idling current will drift after some time. During the normal checking of idling current in the service field, it's acceptable as long as the voltage is in the range of 13.2mV—22.0mV.

D. ISC SENSITIVITY

The ISC sensing voltage can allow 0mV+/-50mV. But, for the alignment process during production, we tighten the limit to 0mV+/-10mV. That is to adjust Pot RV104 (as marked as "ISC SENSE ADJ" in the below drawing) to get a voltage between the "ISC SENSE TEST POINT" and AGND to be 0mV+/-10mV.

(Pls note the ISC should be adjusted when all modules are plugged in. It's not possible to get 0mV +/-10mV if any of the modules are removed.)

E. Fan Cut Off Point Adjustment T973MKII-B

Check the Fan sense voltage first. Turn Pot RV201 to the end clockwise and confirm TP1 of J201 is in negative voltage. Run the unit to heat it up and drive the fan to start turning. For example, all 7 channels at 50W/4ohms for 10 minutes or 5 minutes or even less (as long as the fan can start turning). Turn off the signal but still keep the unit operating for 1 minute. Then run all 7 channels at 1kHz, 0.25W at 4 Ohms load monitor the voltage at TP1 of J201. Adjust RV201 to get the voltage from negative to positive to ensure that the Fans are turned off. Then run all 7 channels at 1kHz, 0.5 W at 4 Ohms load, monitor if the voltage at TP1 of J201 is negative, if not, adjust Pot RV201 just to the point that TP1 changes from positive to negative (to get the fans just start turning). Finally, turn off the signal and monitor if fans stop turning withing about 30s Maximum.

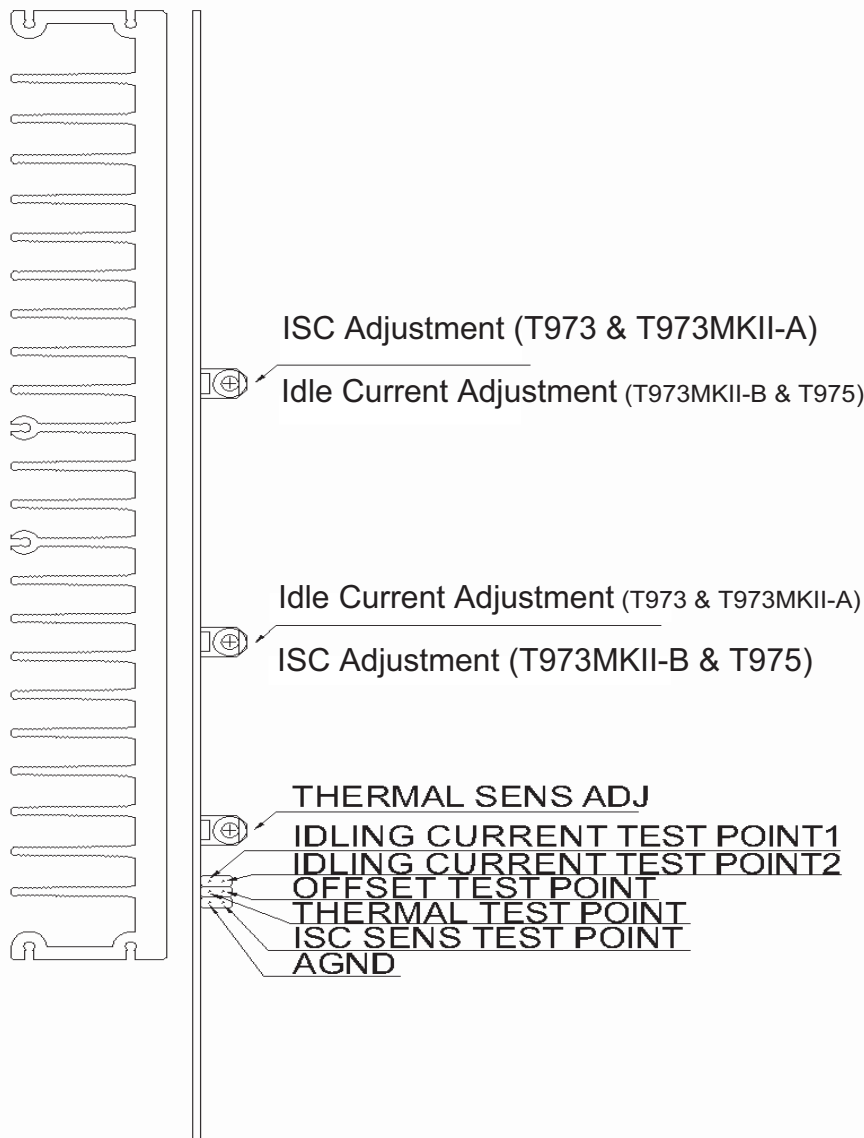

WIRING DIAGRAM

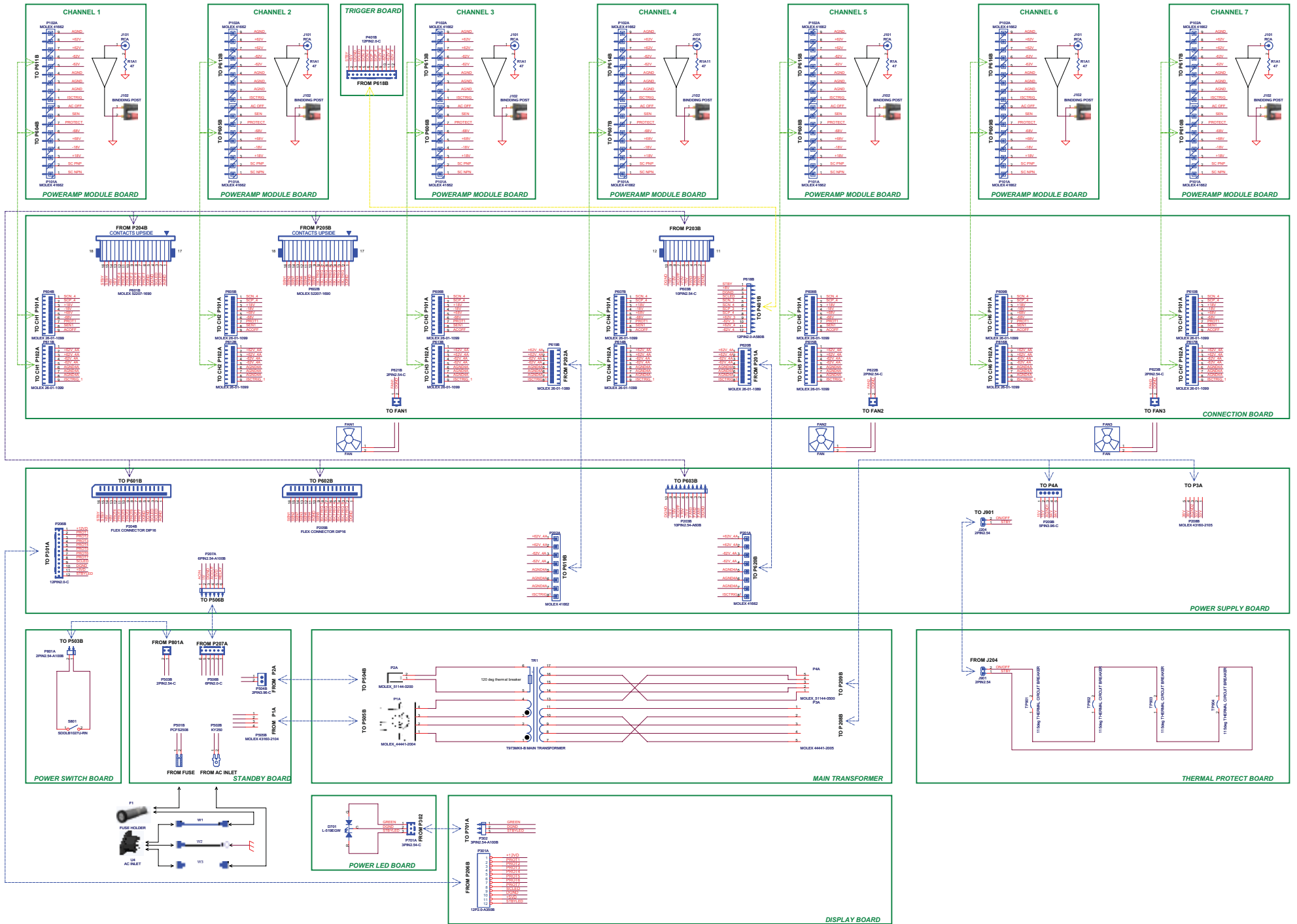

SCHEMATICS DIAGRAM

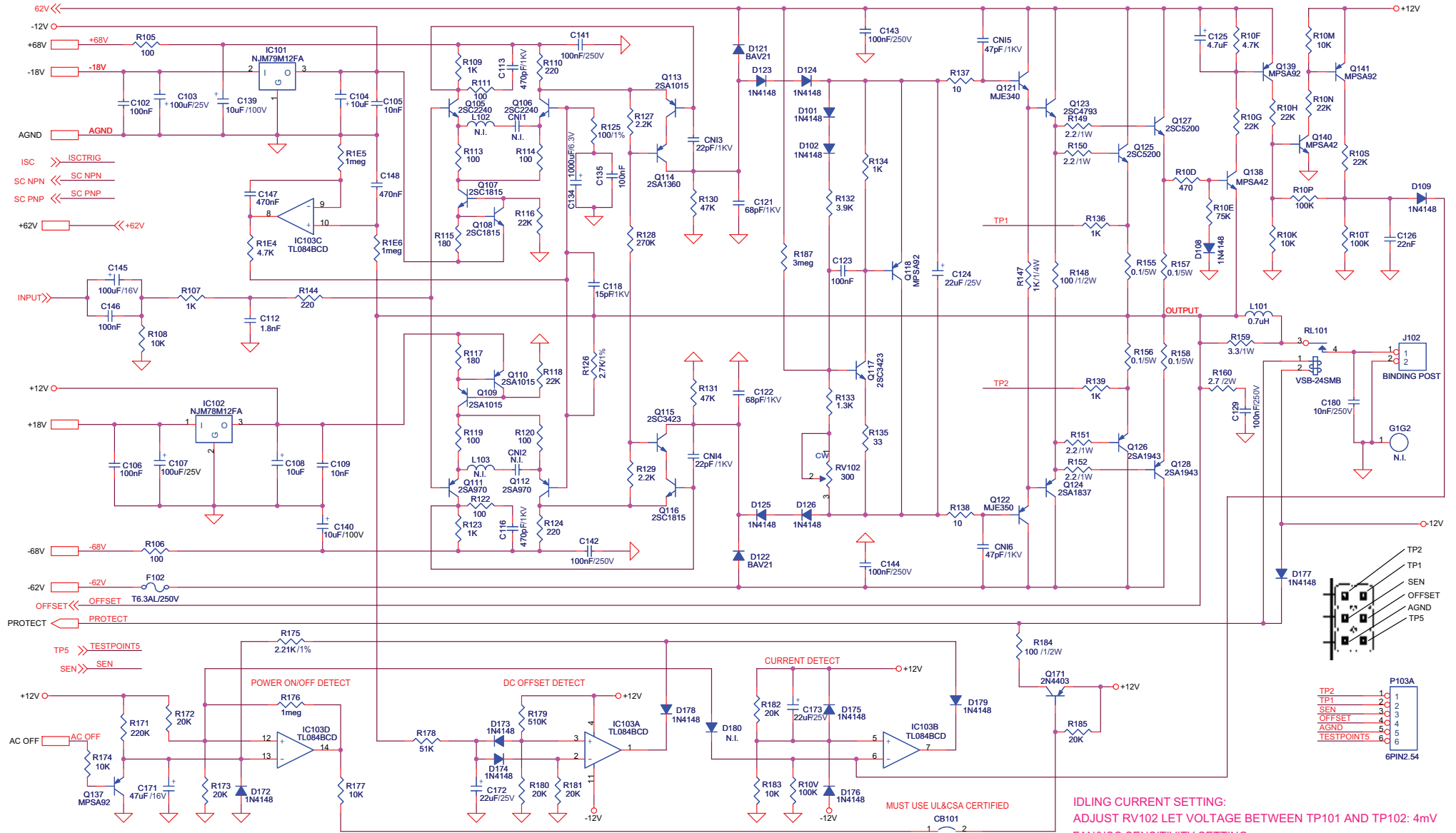

- TO-92 2SA970
- TO-92 2SA1016
- TO-92 2SC2362
- TO-92 2SA1015
- TO-92 2SC1815
- TO-92 2SC2240
- TO-92 2N4403
- TO-92 MPSA06
- TO-92 MPSA56
- TO-92 DGS
- TO-126 2SA1360
- TO-220 2SA1837
- TO-220 2SC4793
- TO-220 NJM78M12A
- TO-220 NJM79M12A
- TO-264 2SA1943
- TO-264 2SC5200

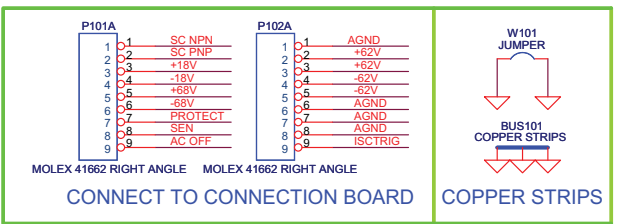

IDLING CURRENT SETTING:
 ADJUST RV102 LET VOLTAGE BETWEEN TP101 AND TP102: 4mV
FAN&ISC SENSITIVITY SETTING
 ADJUST RV103 LET VOLTAGE AT SEN PORT: +750mV/25Deg
 RESISTORS ARE CARBON FILM 1/6W UNLESS SPECIFIED

SCHEMATICS DIAGRAM

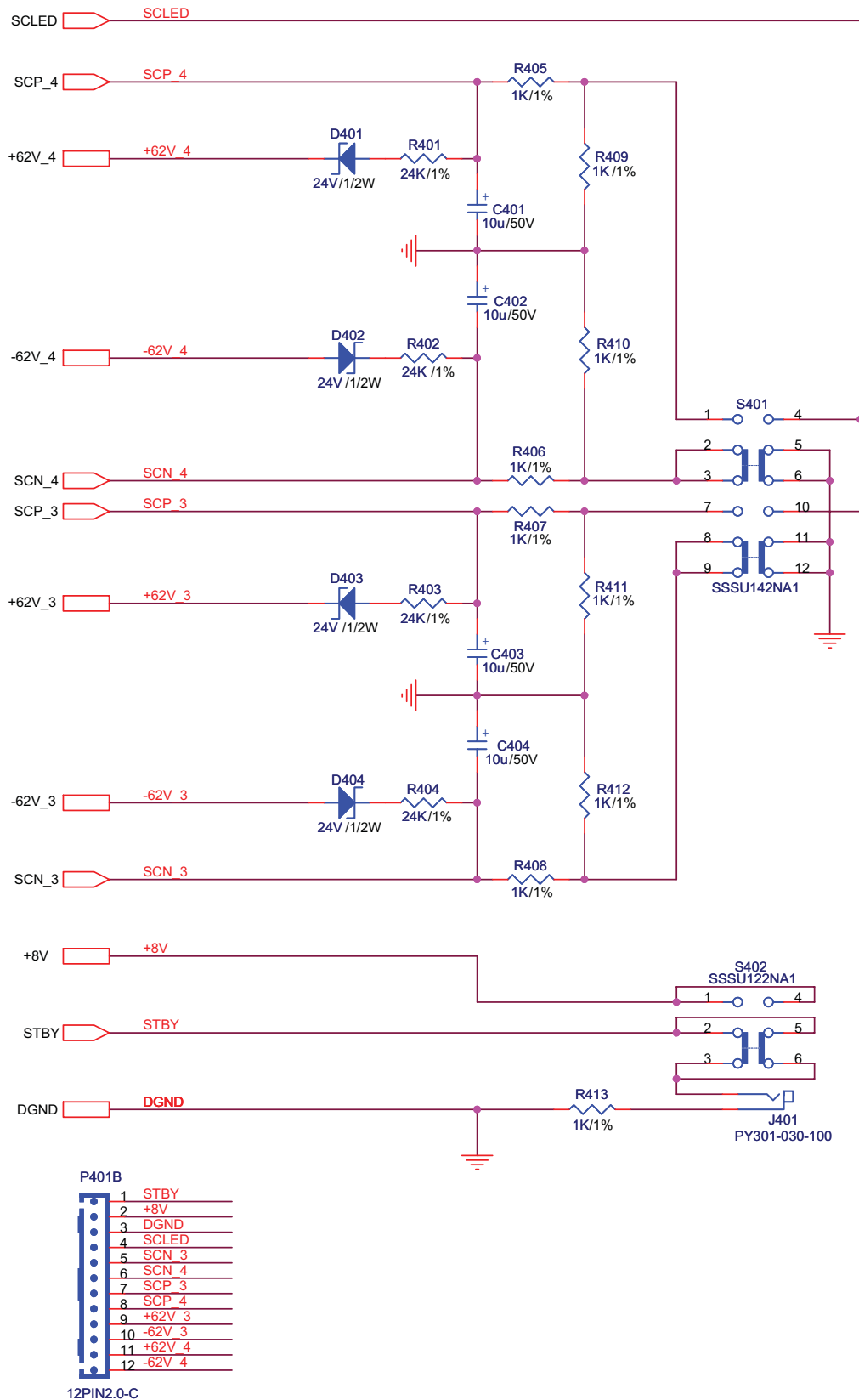

SCHEMATICS DIAGRAM

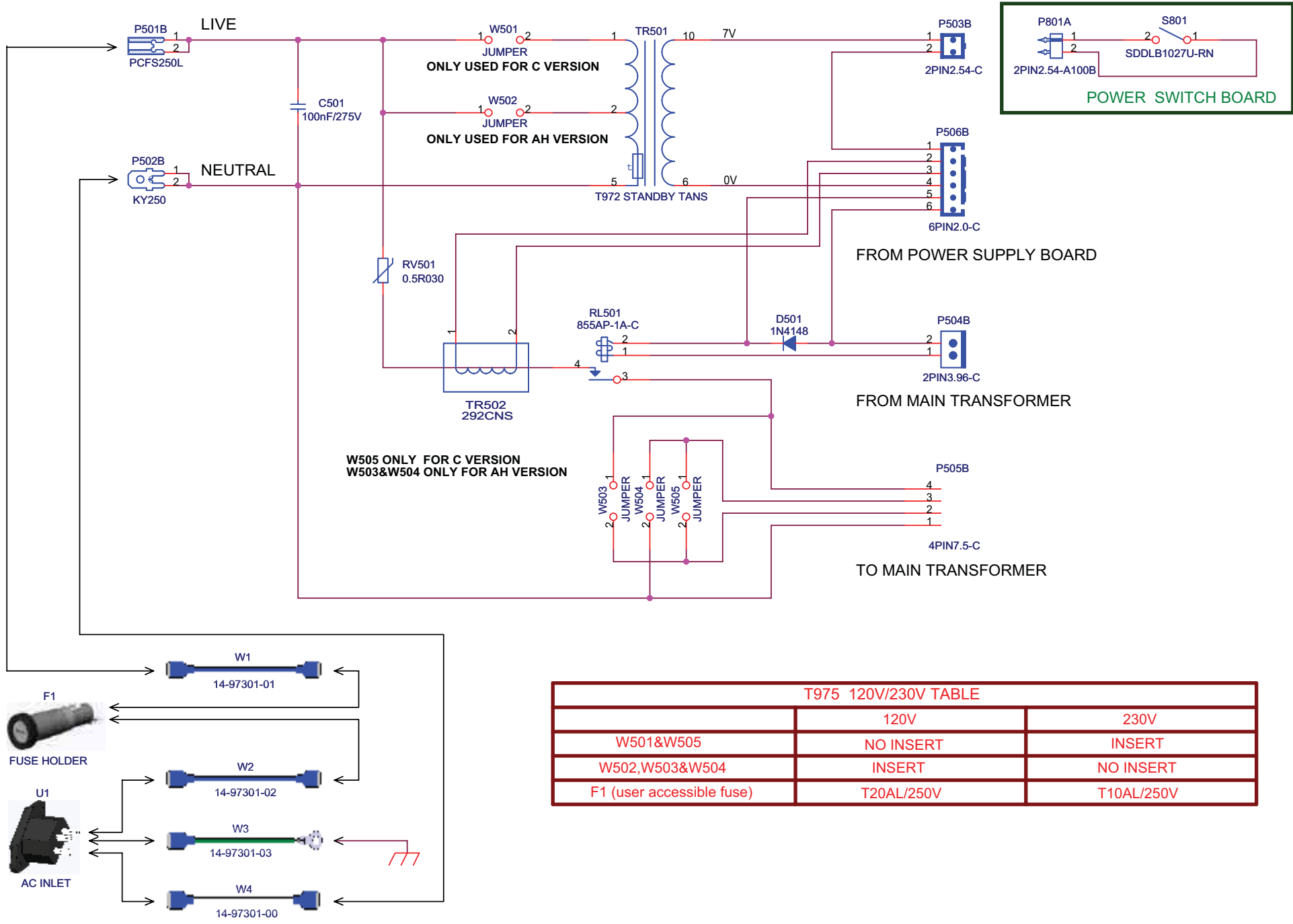

W505 ONLY FOR C VERSION
W503&W504 ONLY FOR AH VERSION

ONLY USED FOR C VERSION
ONLY USED FOR AH VERSION

T975 120V/230V TABLE		
	120V	230V
W501&W505	NO INSERT	INSERT
W502,W503&W504	INSERT	NO INSERT
F1 (user accessible fuse)	T20AL/250V	T10AL/250V

SCHEMATICS DIAGRAM

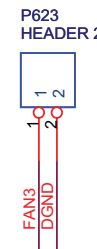
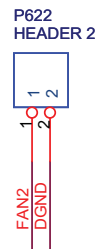
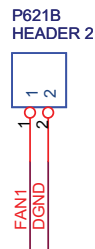
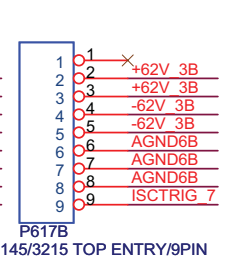
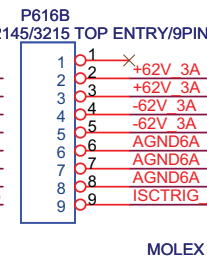
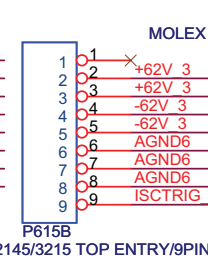
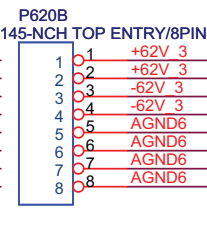
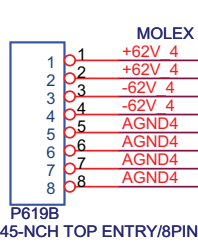
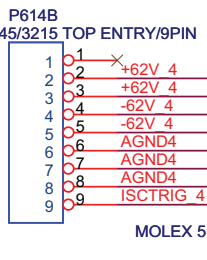
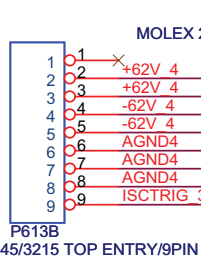
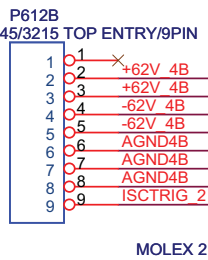
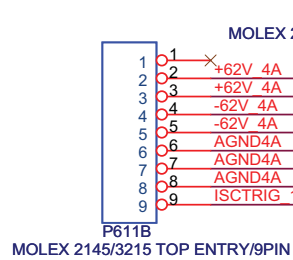
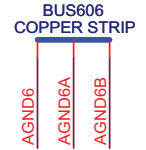
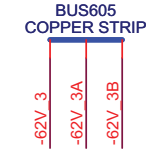
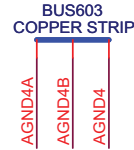
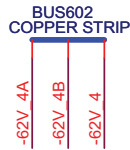
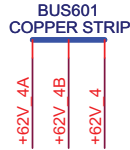
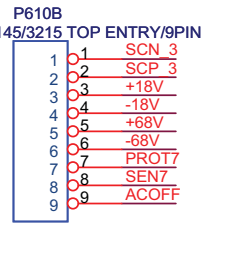
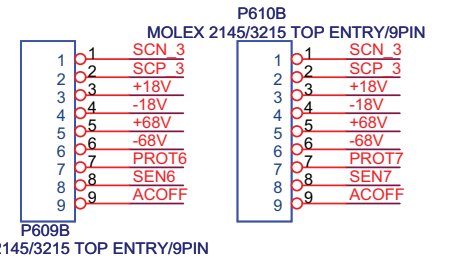
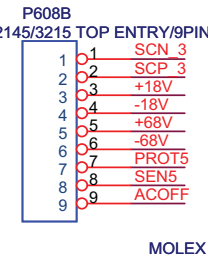
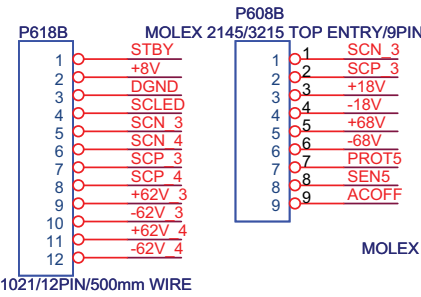
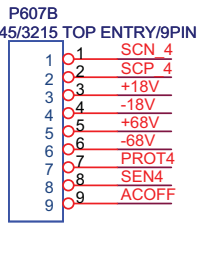
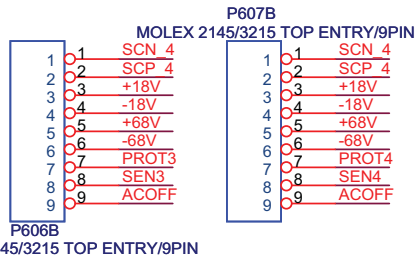
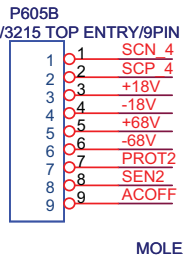
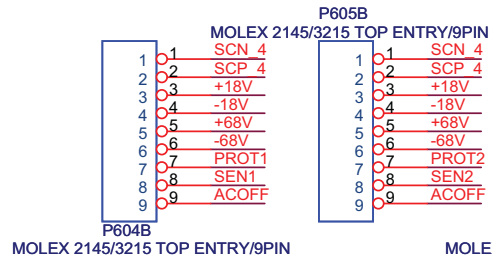
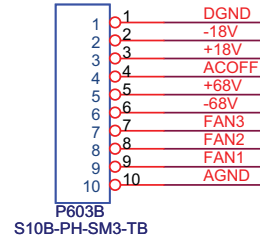
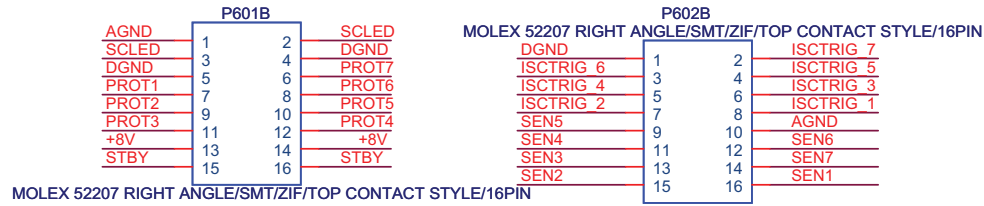

SCHEMATICS DIAGRAM

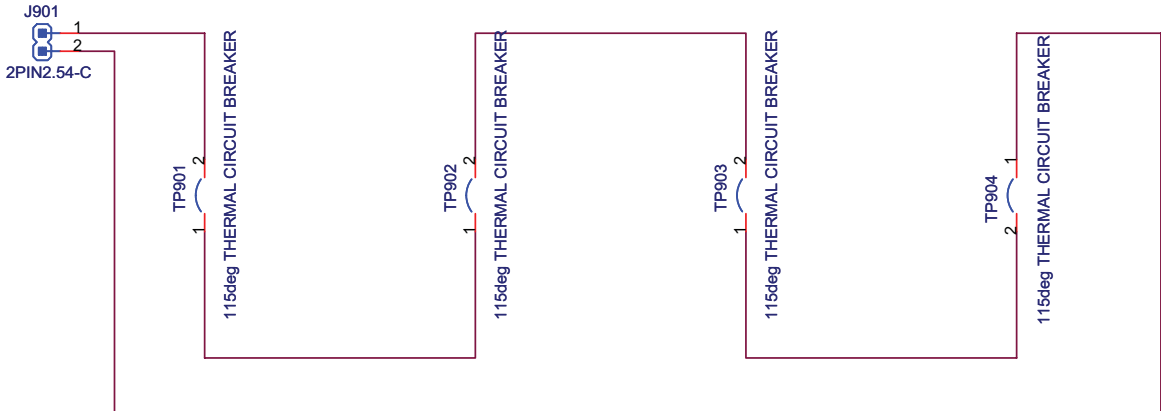

AMP BOARD - COMPONENT SIDE

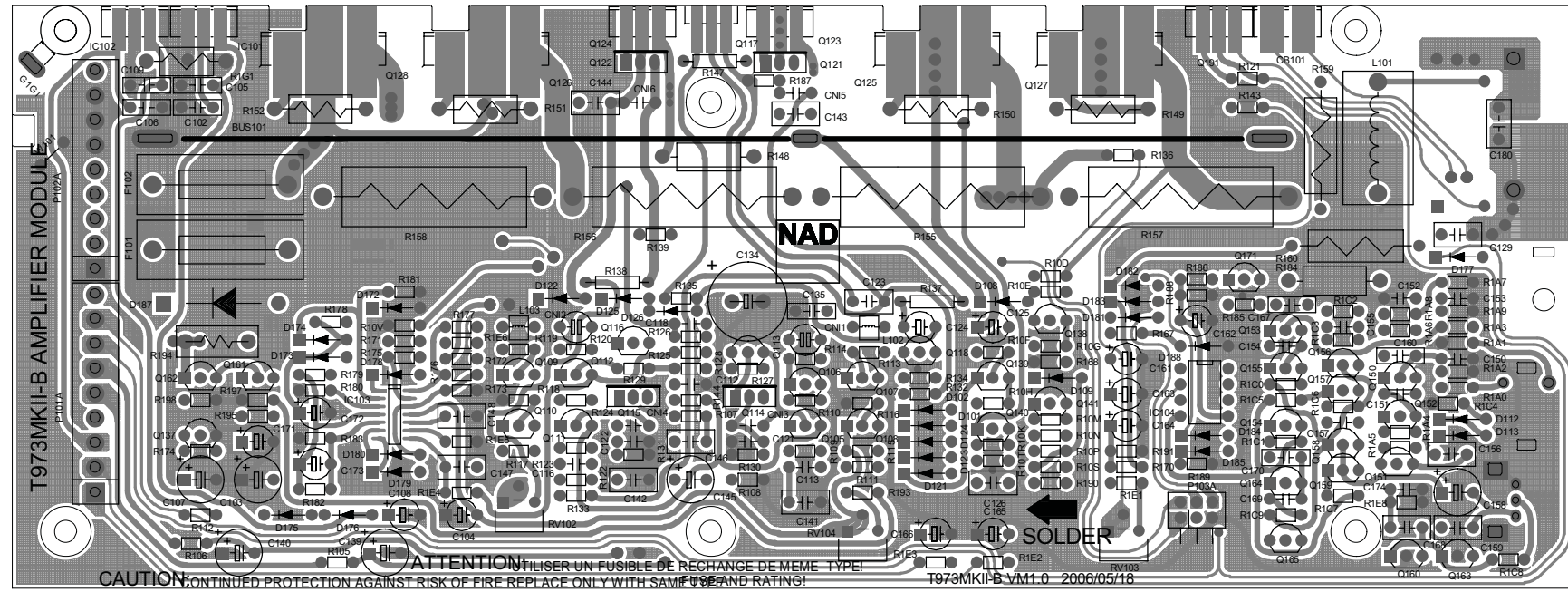

AMP BOARD - SOLDER SIDE

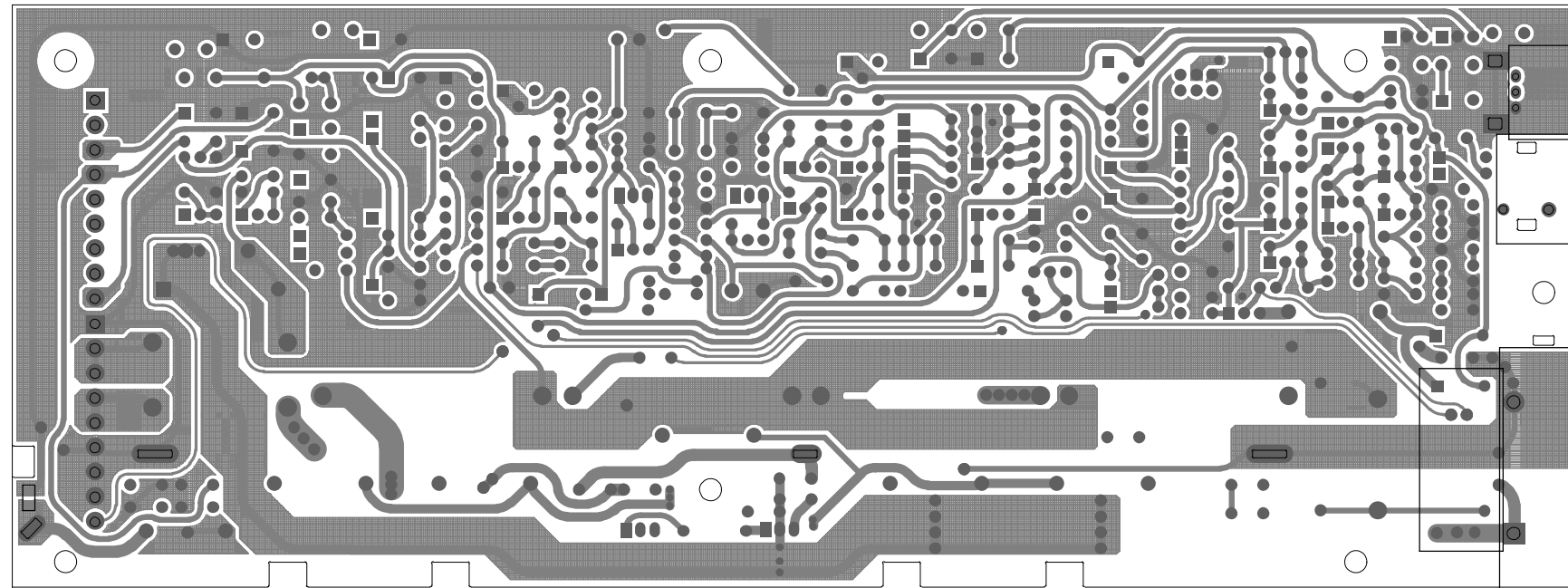

PSU BOARD - COMPONENT SIDE Fan Cut Off Adjustment

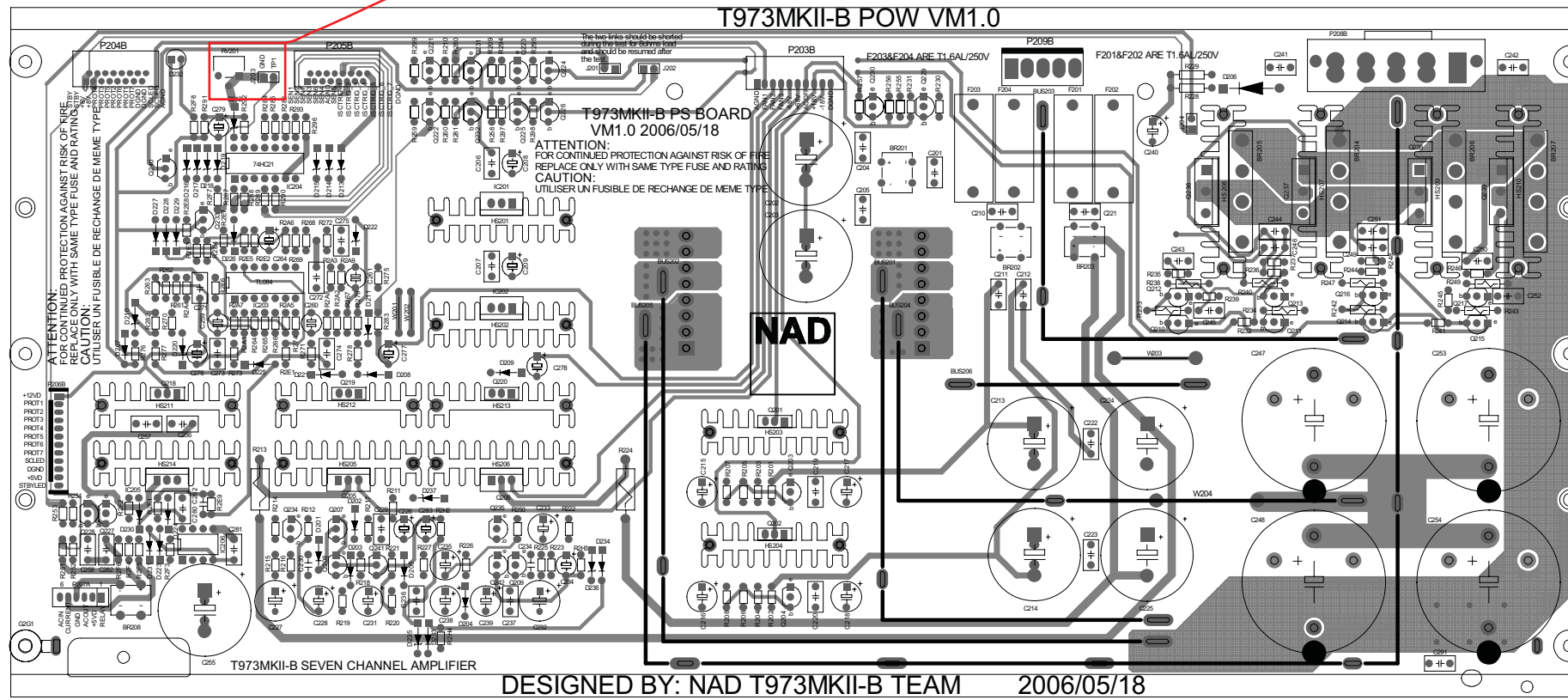

PSU BOARD - SOLDER SIDE

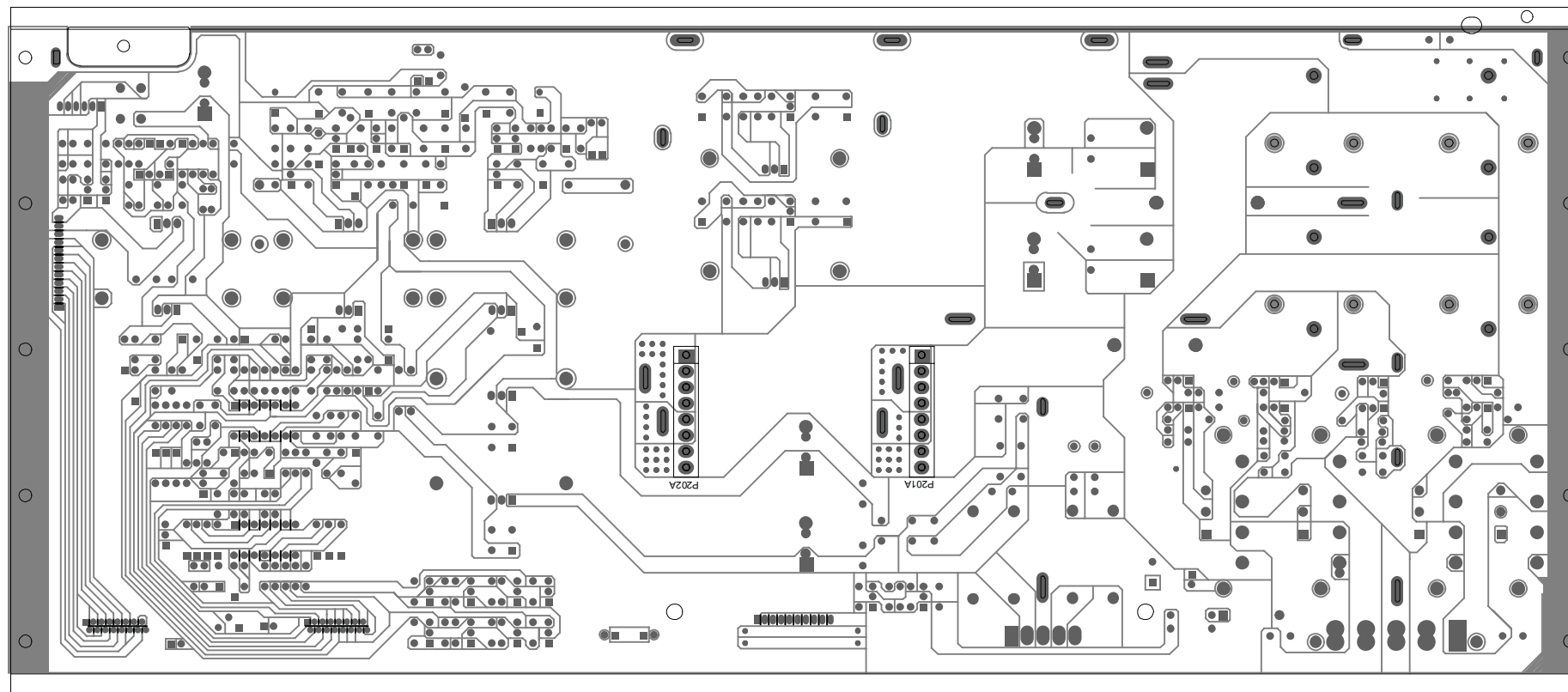

SOFTCLIPPING&PROTECT LED BOARD - COMPONENT SIDE

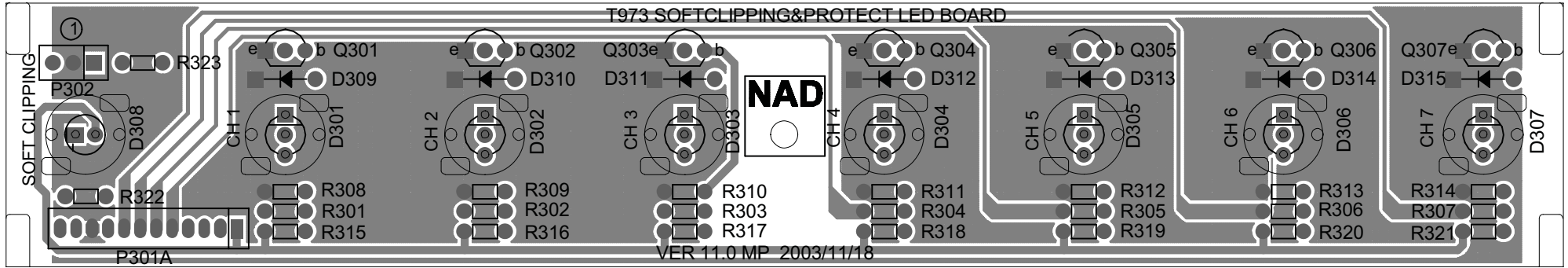

SOFTCLIPPING&PROTECT LED BOARD - SOLDER SIDE

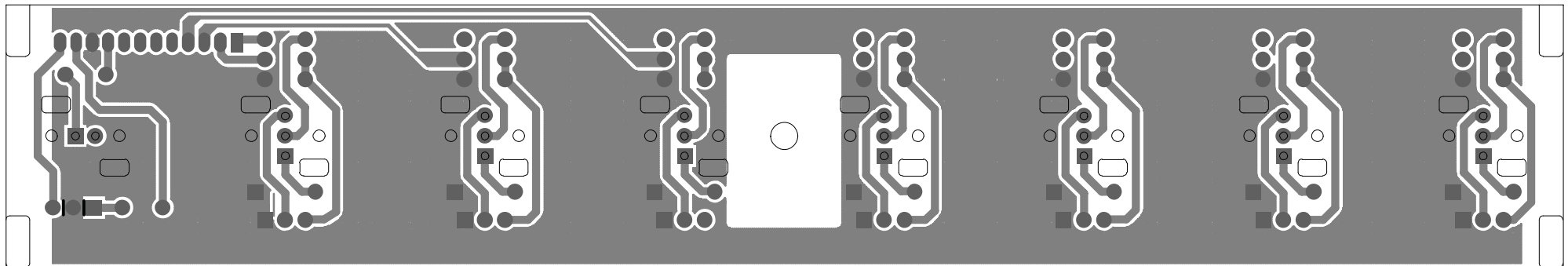

TRIG BOARD - COMPONENT SIDE

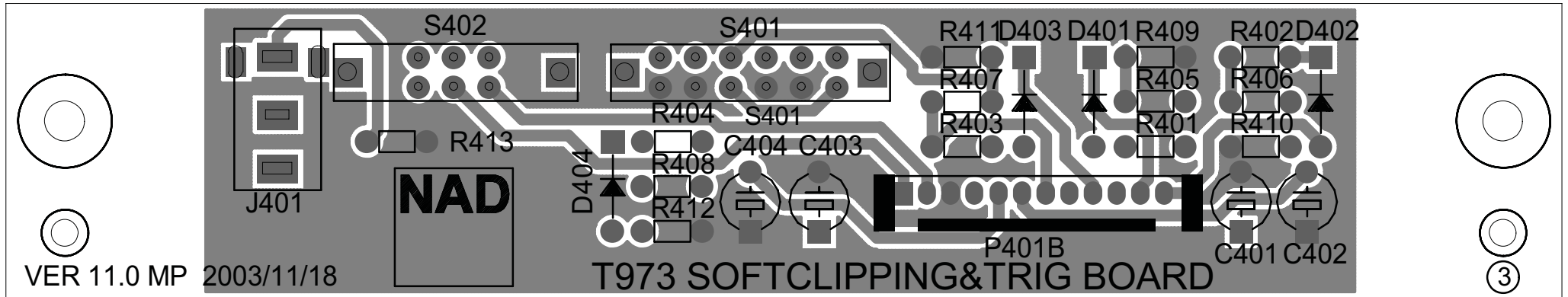

TRIG BOARD - SOLDER SIDE

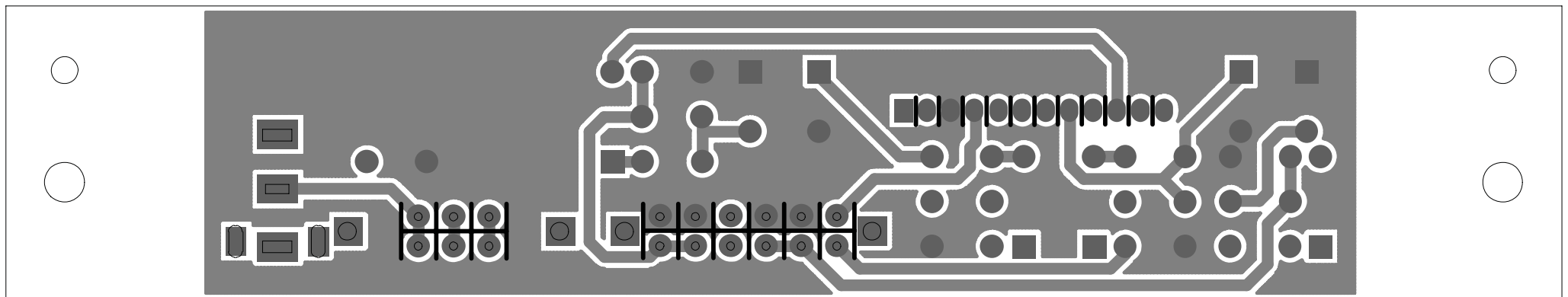

STANDBY BOARD - COMPONENT SIDE

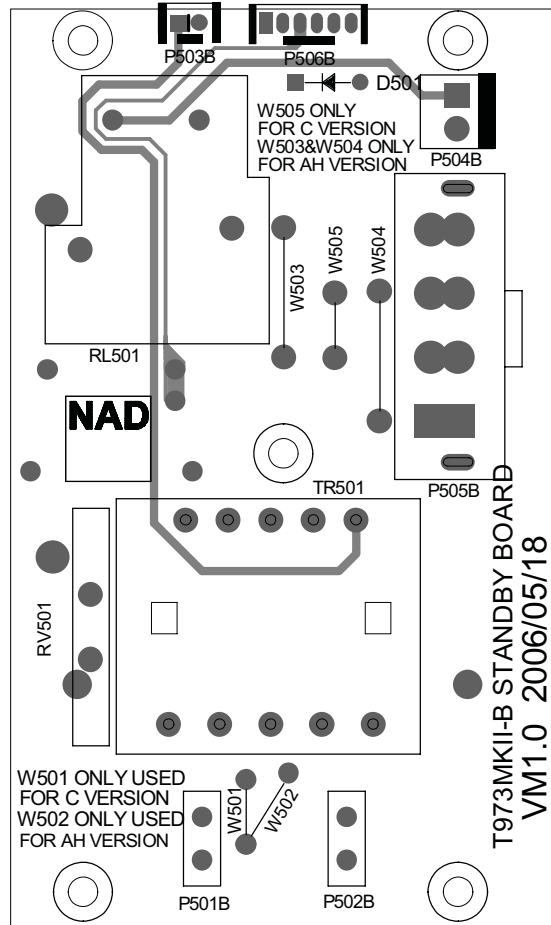

STANDBY BOARD - SOLDER SIDE

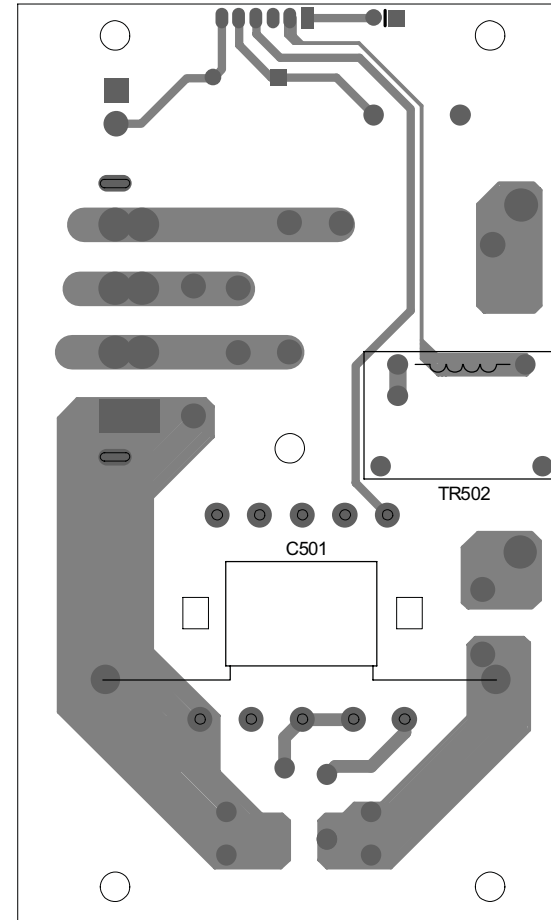

POWER LED BOARD

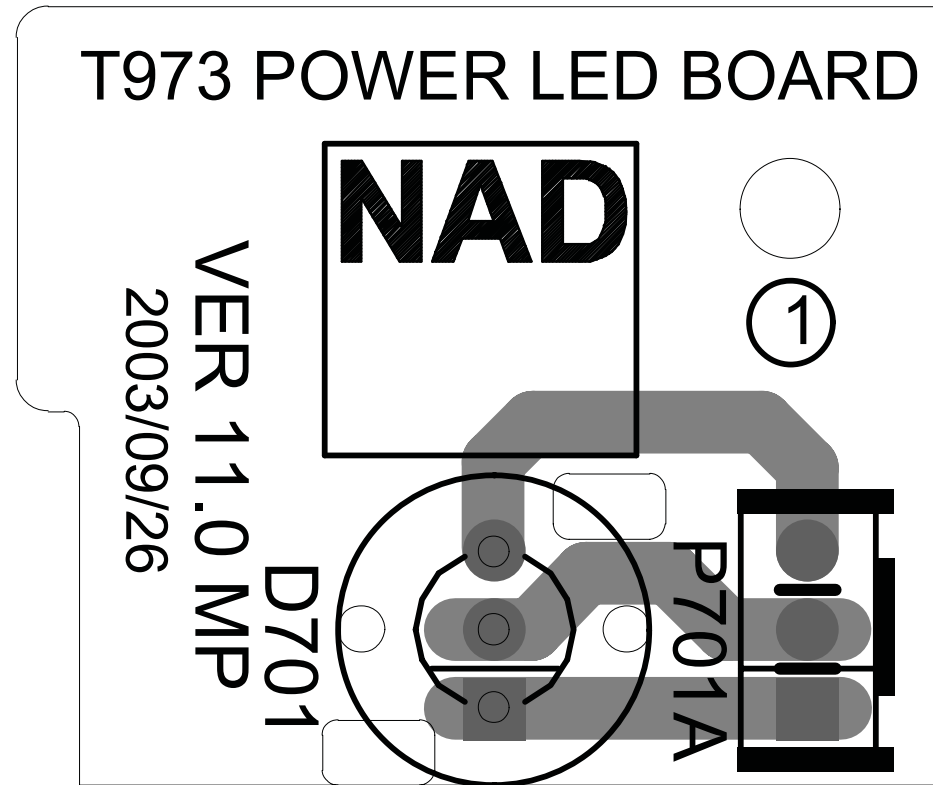

SWITCH BOARD

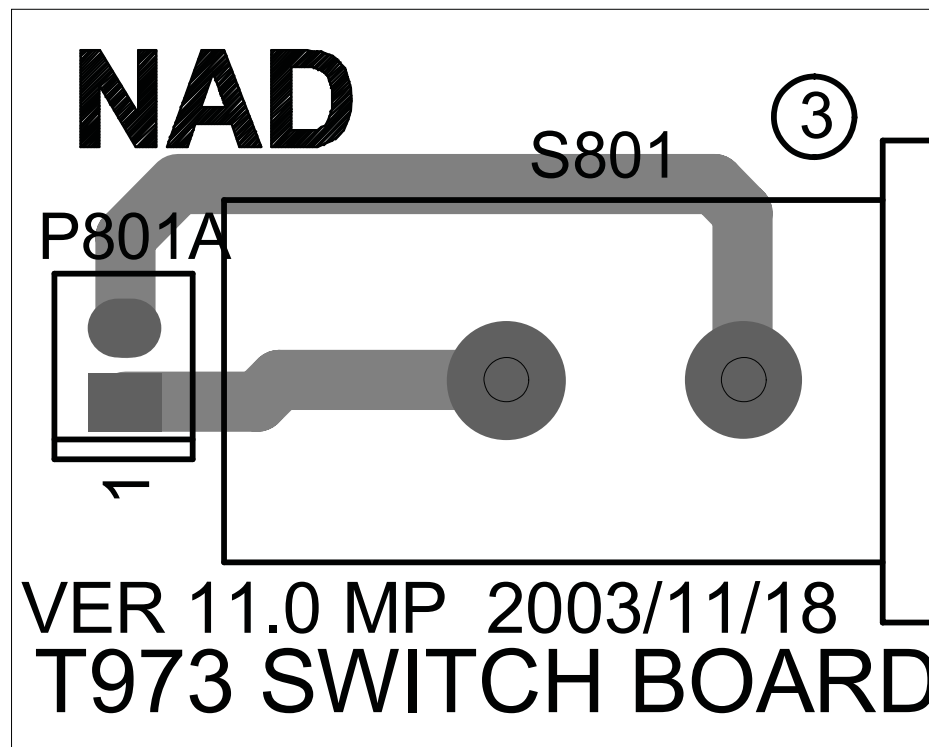

TP BOARD

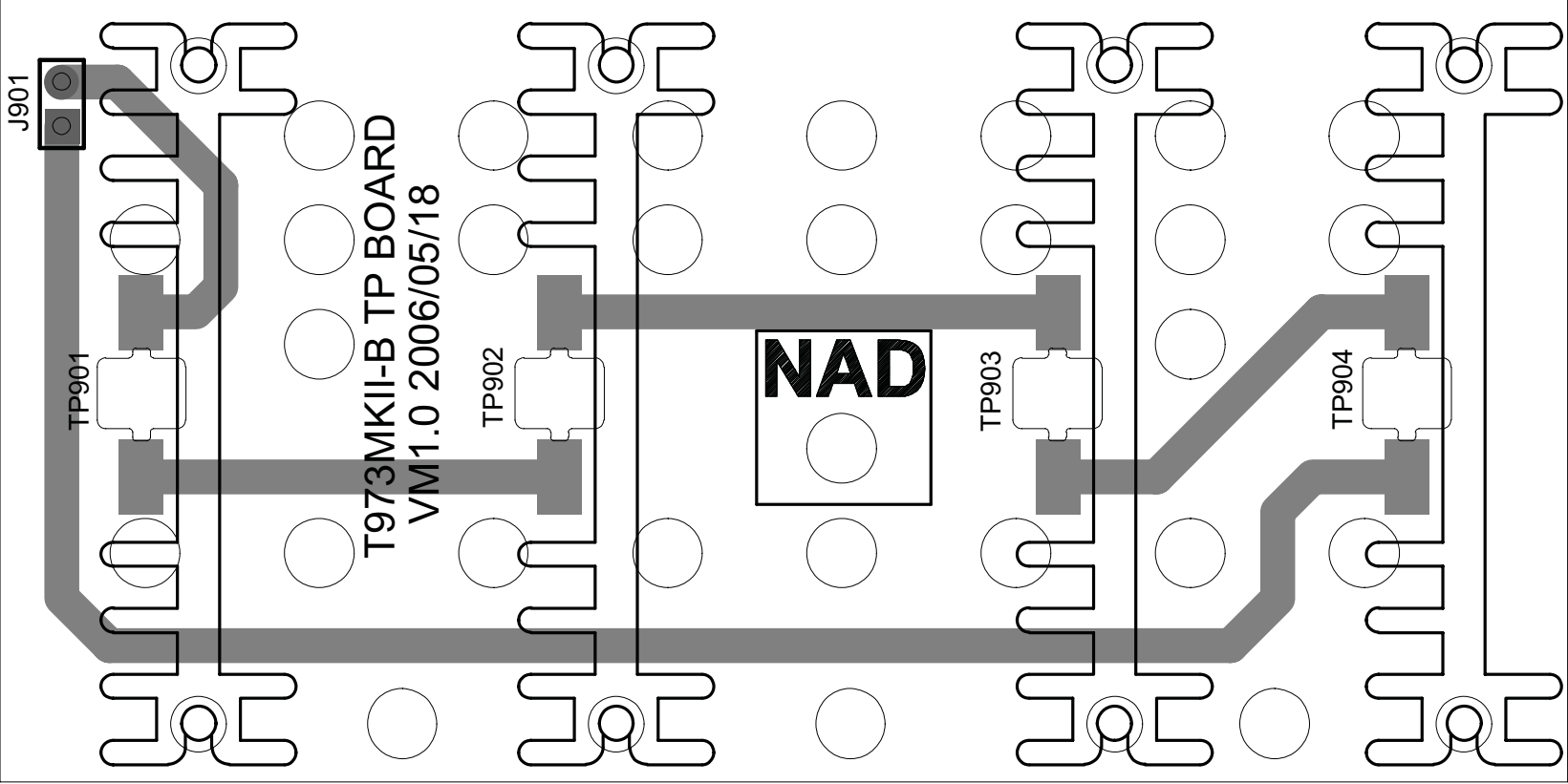

ELECTRICAL PARTS LIST

DESIGNATOR	DESCRIPTION	PART TYPE	PART NUMBER	FOOTPRINT
AH P/N: 01-97301-11 C P/N: 01-97301-21 PCB1 BOARD (AMP)				
DIODE				
D101	Switch Diode	1N4148	33-44148-00	DAX/.300X.080/.031
D102	Switch Diode	1N4148	33-44148-00	DAX/.300X.080/.031
D108	Switch Diode	1N4148	33-44148-00	DAX/.300X.080/.031
D109	Switch Diode	1N4148	33-44148-00	DAX/.300X.080/.031
D112	Switch Diode	1N4148	33-44148-00	DAX/.300X.080/.031
D113	Switch Diode	1N4148	33-44148-00	DAX/.300X.080/.031
D121	Switch Diode	BAV21	33-40021-00	DAX/.300X.080/.031
D122	Switch Diode	BAV21	33-40021-00	DAX/.300X.080/.031
D123	Switch Diode	1N4148	33-44148-00	DAX/.300X.080/.031
D124	Switch Diode	1N4148	33-44148-00	DAX/.300X.080/.031
D125	Switch Diode	1N4148	33-44148-00	DAX/.300X.080/.031
D126	Switch Diode	1N4148	33-44148-00	DAX/.300X.080/.031
D172	Switch Diode	1N4148	33-44148-00	DAX/.300X.080/.031
D173	Switch Diode	1N4148	33-44148-00	DAX/.300X.080/.031
D174	Switch Diode	1N4148	33-44148-00	DAX/.300X.080/.031
D175	Switch Diode	1N4148	33-44148-00	DAX/.300X.080/.031
D176	Switch Diode	1N4148	33-44148-00	DAX/.300X.080/.031
D177	Switch Diode	1N4148	33-44148-00	DAX/.300X.080/.031
D178	Switch Diode	1N4148	33-44148-00	DAX/.300X.080/.031
D179	Switch Diode	1N4148	33-44148-00	DAX/.300X.080/.031
D181	Switch Diode	BAV21	33-40021-00	DAX/.300X.080/.031
D182	Zener Diode	4.7V, 1/2W	33-14709-00	DAX/.300X.080/.031
D183	Switch Diode	BAV21	33-40021-00	DAX/.300X.080/.031
D184	Switch Diode	1N4148	33-44148-00	DAX/.300X.080/.031
D185	Switch Diode	1N4148	33-44148-00	DAX/.300X.080/.031
D187	Recti Diode	1N5404	33-25404-00	DAX1/1N_5400-5408
D188	Zener Diode	6.8V, 1/2W	33-16809-00	DAX/.300X.080/.031
TRANSISTOR				
Q105	Transistor	2SC2362	31-02362-00	TO92/100/ECB
Q105	Transistor	2SC2240-GR	31-02240-00	TO92/100/ECB
Q106	Transistor	2SC2362	31-02362-00	TO92/100/ECB
Q106	Transistor	2SC2240-GR	31-02240-00	TO92/100/ECB
Q107	Transistor	2SC1815-GR	31-01815-00	TO92/100/ECB
Q108	Transistor	2SC1815-GR	31-01815-00	TO92/100/ECB
Q109	Transistor	2SA1015-GR	31-01015-00	TO92/100/ECB
Q110	Transistor	2SA1015-GR	31-01015-00	TO92/100/ECB
Q111	Transistor	2SA970-GR	31-00970-00	TO92/100/ECB
Q112	Transistor	2SA1016	31-01016-00	TO92/100/ECB
Q112	Transistor	2SA970-GR	31-00970-00	TO92/100/ECB
Q113	Transistor	2SA1015-GR	31-01015-00	TO92/100/ECB
Q114	Transistor	2SA1360-O	R31-01360-00	TO126/90/ECB
Q115	Transistor	2SC3423-O	R31-03423-00	TO126/90/ECB
Q116	Transistor	2SC1815-GR	31-01815-00	TO92/100/ECB
Q117	Transistor	2SC3423-O	R31-03423-00	TO126/90/ECB
Q118	Transistor	MPSA92	31-00092-00	TO92/100/EBC
Q121	Transistor	MJE340	31-00340-01	TO126/90/ECB
Q122	Transistor	MJE350	31-00350-01	TO126/90/ECB
Q123	Transistor	2SC4793	31-04793-00	TO220AB/215/SURFACE/BCE
Q124	Transistor	2SA1837	31-01837-00	TO220AB/215/SURFACE/BCE
Q125	Transistor	2SC5200-O	R31-05200-00	TO264/215/SURFACE/BCE
Q126	Transistor	2SA1943-O	R31-01943-00	TO264/215/SURFACE/BCE
Q127	Transistor	2SC5200-O	R31-05200-00	TO264/215/SURFACE/BCE
Q128	Transistor	2SA1943-O	R31-01943-00	TO264/215/SURFACE/BCE
Q138	Transistor	MPSA42	31-00042-00	TO92/100/EBC
Q139	Transistor	MPSA92	31-00092-00	TO92/100/EBC
Q140	Transistor	MPSA42	31-00042-00	TO92/100/EBC
Q141	Transistor	MPSA92	31-00092-00	TO92/100/EBC
Q150	Transistor	2SK170-BL	31-00170-00	TO92/100/DGS
Q151	Transistor	2SC2362	31-02362-00	TO92/100/ECB
Q151	Transistor	2SC2240-GR	31-02240-00	TO92/100/ECB
Q152	Transistor	2SA970-GR	31-00970-00	TO92/100/ECB
Q153	Transistor	2SK170-BL	31-00170-00	TO92/100/DGS
Q154	Transistor	2SC2362	31-02362-00	TO92/100/ECB
Q154	Transistor	2SC2240-GR	31-02240-00	TO92/100/ECB
Q155	Transistor	2SA970-GR	31-00970-00	TO92/100/ECB
Q156	Transistor	2SC2362	31-02362-00	TO92/100/ECB
Q156	Transistor	2SC2240-GR	31-02240-00	TO92/100/ECB

ELECTRICAL PARTS LIST

DESIGNATOR	DESCRIPTION	PART TYPE	PART NUMBER	FOOTPRINT
Q157	Transistor	2SC2362	31-02362-00	TO92/100/ECB
Q157	Transistor	2SC2240-GR	31-02240-00	TO92/100/ECB
Q158	Transistor	2SA970-GR	31-00970-00	TO92/100/ECB
Q159	Transistor	2SC2362	31-02362-00	TO92/100/ECB
Q159	Transistor	2SC2240-GR	31-02240-00	TO92/100/ECB
Q160	Transistor	2SC1815-GR	31-01815-00	TO92/100/ECB
Q161	Transistor	MPSA92	31-00092-00	TO92/100/EBC
Q162	Transistor	MPSA92	31-00092-00	TO92/100/EBC
Q163	Transistor	2SA1015-GR	31-01015-00	TO92/100/ECB
Q164	Transistor	2SK170-BL	31-00170-00	TO92/100/DGS
Q165	Transistor	2SA970-GR	31-00970-00	TO92/100/ECB
Q171	Transistor	2N4403	31-04403-00	TO92/100/ECB
Q191	Transistor	2SC4793	31-04793-00	TO220AB/215/SURFACE/BCE
THERMAL SWITCH				
CB101	THERMAL CIRCUIT BRAKE	67L090	03-67090-00	TO220AC/SURFACE
IC				
IC101	RAGULATOR	NJM79M12FA	03-07912-20	TO220AB/SURFACE
IC102	RAGULATOR	NJM78M12FA	03-07812-20	TO220AB/SURFACE
IC103	QUAD OP-AMP	TL084BCD	03-00084-02	SOG.050/14/WG.244/L.375
IC104	DUAL OP-AMP	TL082CP	03-00082-00	DIP.100/8/W.300/L.750
RESISTOR				
R105	Metal Film Resistor	100Ω, 1/6W, 5%	07-20101-50	AXI.200X.080/031
R106	Metal Film Resistor	100Ω, 1/6W, 5%	07-20101-50	AXI.200X.080/031
R107	Metal Film Resistor	1KΩ, 1/6W, 5%	07-20102-50	AXI.200X.080/031
R108	Metal Film Resistor	10KΩ, 1/6W, 5%	07-20103-50	AXI.200X.080/031
R109	Metal Film Resistor	1KΩ, 1/6W, 5%	07-20102-50	AXI.200X.080/031
R110	Metal Film Resistor	220Ω, 1/6W, 5%	07-20221-50	AXI.200X.080/031
R111	Metal Film Resistor	100Ω, 1/6W, 5%	07-20101-50	AXI.200X.080/031
R112	Metal Film Resistor	3K3Ω, 1/6W, 1%	07-23301-50	AXI.200X.080/031
R113	Metal Film Resistor	100Ω, 1/6W, 5%	07-20101-50	AXI.200X.080/031
R114	Metal Film Resistor	100Ω, 1/6W, 5%	07-20101-50	AXI.200X.080/031
R115	Metal Film Resistor	180Ω, 1/6W, 5%	07-20181-50	AXI.200X.080/031
R116	Metal Film Resistor	22KΩ, 1/6W, 5%	07-20223-50	AXI.200X.080/031
R117	Metal Film Resistor	180Ω, 1/6W, 5%	07-20181-50	AXI.200X.080/031
R118	Metal Film Resistor	22KΩ, 1/6W, 5%	07-20223-50	AXI.200X.080/031
R119	Metal Film Resistor	100Ω, 1/6W, 5%	07-20101-50	AXI.200X.080/031
R120	Metal Film Resistor	100Ω, 1/6W, 5%	07-20101-50	AXI.200X.080/031
R121	Metal Film Resistor	33KΩ, 1/6W, 1%	07-23302-50	AXI.200X.080/031
R122	Metal Film Resistor	100Ω, 1/6W, 5%	07-20101-50	AXI.200X.080/031
R123	Metal Film Resistor	1KΩ, 1/6W, 5%	07-20102-50	AXI.200X.080/031
R124	Metal Film Resistor	220Ω, 1/6W, 5%	07-20221-50	AXI.200X.080/031
R125	Metal Film Resistor	100Ω, 1/6W, 1%	07-21000-50	AXI.200X.080/031
R126	Metal Film Resistor	2K7Ω, 1/6W, 1%	07-22701-50	AXI.200X.080/031
R127	Metal Film Resistor	2K2Ω, 1/6W, 5%	07-20222-50	AXI.200X.080/031
R128	Metal Film Resistor	270KΩ, 1/6W, 5%	07-20274-50	AXI.200X.080/031
R129	Metal Film Resistor	2K2Ω, 1/6W, 5%	07-20222-50	AXI.200X.080/031
R130	Metal Film Resistor	47KΩ, 1/6W, 5%	07-20473-50	AXI.200X.080/031
R131	Metal Film Resistor	47KΩ, 1/6W, 5%	07-20473-50	AXI.200X.080/031
R132	Metal Film Resistor	3K9Ω, 1/6W, 5%	07-20392-50	AXI.200X.080/031
R133	Metal Film Resistor	1K3Ω, 1/6W, 1%	07-21301-50	AXI.200X.080/031
R134	Metal Film Resistor	1KΩ, 1/6W, 5%	07-20102-50	AXI.200X.080/031
R135	Metal Film Resistor	33Ω, 1/6W, 5%	07-20330-50	AXI.200X.080/031
R136	Metal Film Resistor	1KΩ, 1/6W, 5%	07-20102-50	AXI.200X.080/031
R137	Metal Film Resistor	10Ω, 1/4W, 5%	07-20100-51	AXI.400X.080/031
R138	Metal Film Resistor	10Ω, 1/4W, 5%	07-20100-51	AXI.400X.080/031
R139	Metal Film Resistor	1KΩ, 1/6W, 5%	07-20102-50	AXI.200X.080/031
R143	Metal Film Resistor	1K5Ω, 1/6W, 5%	07-20152-50	AXI.200X.080/031
R144	Metal Film Resistor	220Ω, 1/6W, 5%	07-20221-50	AXI.200X.080/031
R147	FUSEABLE Resistor	1KΩ, 1/4W, 5%	07-50102-00	AXI.400X.080/031
R148	Metal Oxide Film Resistor	100Ω, 1/2W, 5%	07-30101-00	AXI.600X.125/039
R149	Metal Oxide Film Resistor	2.2Ω, 1W, 5%	07-30229-01	AXI.600X.125/039
R150	Metal Oxide Film Resistor	2.2Ω, 1W, 5%	07-30229-01	AXI.600X.125/039
R151	Metal Oxide Film Resistor	2.2Ω, 1W, 5%	07-30229-01	AXI.600X.125/039
R152	Metal Oxide Film Resistor	2.2Ω, 1W, 5%	07-30229-01	AXI.600X.125/039
R155	Cement Resistor	0.1Ω, 5W, 5%	07-60108-06	AXI.1380X.375/047
R156	Cement Resistor	0.1Ω, 5W, 5%	07-60108-06	AXI.1380X.375/047
R157	Cement Resistor	0.1Ω, 5W, 5%	07-60108-06	AXI.1380X.375/047
R158	Cement Resistor	0.1Ω, 5W, 5%	07-60108-06	AXI.1380X.375/047
R159	Metal Oxide Film Resistor	3.3Ω, 1W, 5%	07-30339-10	AXI.800X.200/037

ELECTRICAL PARTS LIST

DESIGNATOR	DESCRIPTION	PART TYPE	PART NUMBER	FOOTPRINT
R160	Metal Oxide Film Resistor	2.7Ω, 2W, 5%	07-30279-02	AXI.800X.200/.037
R167	Metal Film Resistor	220KΩ, 1/6W, 5%	07-20224-50	AXI.200X.080/.031
R168	Metal Film Resistor	100KΩ, 1/6W, 5%	07-20104-50	AXI.200X.080/.031
R170	Metal Film Resistor	470kΩ, 1/6W, 5%	07-20474-50	AXI.200X.080/.031
R171	Metal Film Resistor	220KΩ, 1/6W, 5%	07-20224-50	AXI.200X.080/.031
R172	Metal Film Resistor	20KΩ, 1/6W, 5%	07-20203-50	AXI.200X.080/.031
R173	Metal Film Resistor	20KΩ, 1/6W, 5%	07-20203-50	AXI.200X.080/.031
R174	Metal Film Resistor	10KΩ, 1/6W, 5%	07-20103-50	AXI.200X.080/.031
R175	Metal Film Resistor	2K21Ω, 1/6W, 1%	07-22211-50	AXI.200X.080/.031
R176	Metal Film Resistor	1megΩ, 1/6W, 5%	07-20105-50	AXI.200X.080/.031
R177	Metal Film Resistor	10KΩ, 1/6W, 5%	07-20103-50	AXI.200X.080/.031
R178	Metal Film Resistor	51KΩ, 1/6W, 5%	07-20513-50	AXI.200X.080/.031
R179	Metal Film Resistor	510KΩ, 1/6W, 5%	07-20514-50	AXI.200X.080/.031
R180	Metal Film Resistor	20KΩ, 1/6W, 5%	07-20203-50	AXI.200X.080/.031
R181	Metal Film Resistor	20KΩ, 1/6W, 5%	07-20203-50	AXI.200X.080/.031
R182	Metal Film Resistor	20KΩ, 1/6W, 5%	07-20203-50	AXI.200X.080/.031
R183	Metal Film Resistor	10KΩ, 1/6W, 5%	07-20103-50	AXI.200X.080/.031
R184	Metal Oxide Film Resistor	100Ω, 1/2W, 5%	07-30101-00	AXI.600X.125/.039
R185	Metal Film Resistor	20KΩ, 1/6W, 5%	07-20203-50	AXI.200X.080/.031
R186	Metal Film Resistor	390KΩ, 1/6W, 5%	07-20394-50	AXI.200X.080/.031
R187	Metal Film Resistor	3meg Ω, 1/6W, 5%	07-20305-50	AXI.200X.080/.031
R188	Metal Film Resistor	220KΩ, 1/6W, 5%	07-20224-50	AXI.200X.080/.031
R189	Metal Film Resistor	10KΩ, 1/6W, 5%	07-20103-50	AXI.200X.080/.031
R190	Metal Film Resistor	220KΩ, 1/6W, 5%	07-20224-50	AXI.200X.080/.031
R191	Metal Film Resistor	220KΩ, 1/6W, 5%	07-20224-50	AXI.200X.080/.031
R193	Metal Film Resistor	47KΩ, 1/6W, 5%	07-20473-50	AXI.200X.080/.031
R194	Metal Oxide Film Resistor	0.05Ω, 3W, 5%	07-40507-04	RAD/.525X.200/LS.315/.039
R195	Metal Film Resistor	100Ω, 1/6W, 5%	07-20101-50	AXI.200X.080/.031
R197	Metal Film Resistor	6K8Ω, 1/6W, 5%	07-20682-50	AXI.200X.080/.031
R198	Metal Film Resistor	470kΩ, 1/6W, 5%	07-20474-50	AXI.200X.080/.031
R1A0	Metal Film Resistor	470Ω, 1/6W, 5%	07-20471-50	AXI.200X.080/.031
R1A1	Metal Film Resistor	47Ω, 1/6W, 5%	07-20470-50	AXI.200X.080/.031
R1A2	Metal Film Resistor	2.2megΩ, 1/6W, 5%	07-20225-50	AXI.200X.080/.031
R1A3	Metal Film Resistor	470Ω, 1/6W, 5%	07-20471-50	AXI.200X.080/.031
R1A4	Metal Film Resistor	1KΩ, 1/6W, 5%	07-20102-50	AXI.200X.080/.031
R1A5	Metal Film Resistor	82Ω, 1/6W, 5%	07-20820-50	AXI.200X.080/.031
R1A6	Metal Film Resistor	1KΩ, 1/6W, 1%	07-21001-50	AXI.200X.080/.031
R1A7	Metal Film Resistor	AOT, 1/6W, 1%	07-2****-00	AXI.200X.080/.031
R1A8	Metal Film Resistor	976Ω, 1/6W, 1%	07-29760-50	AXI.200X.080/.031
R1A9	Metal Film Resistor	2.2megΩ, 1/6W, 5%	07-20225-50	AXI.200X.080/.031
R1C0	Metal Film Resistor	1KΩ, 1/6W, 5%	07-20102-50	AXI.200X.080/.031
R1C1	Metal Film Resistor	82Ω, 1/6W, 5%	07-20820-50	AXI.200X.080/.031
R1C2	Metal Film Resistor	1KΩ, 1/6W, 1%	07-21001-50	AXI.200X.080/.031
R1C3	Metal Film Resistor	1KΩ, 1/6W, 1%	07-21001-50	AXI.200X.080/.031
R1C4	Metal Film Resistor	22KΩ, 1/6W, 5%	07-20223-50	AXI.200X.080/.031
R1C5	Metal Film Resistor	1KΩ, 1/6W, 5%	07-20102-50	AXI.200X.080/.031
R1C6	Metal Film Resistor	1K8Ω, 1/6W, 5%	07-20182-50	AXI.200X.080/.031
R1C7	Metal Film Resistor	82Ω, 1/6W, 5%	07-20820-50	AXI.200X.080/.031
R1C8	Metal Film Resistor	470Ω, 1/6W, 5%	07-20471-50	AXI.200X.080/.031
R1C9	Metal Film Resistor	1KΩ, 1/6W, 5%	07-20102-50	AXI.200X.080/.031
R1E1	Metal Film Resistor	1KΩ, 1/6W, 5%	07-20102-50	AXI.200X.080/.031
R1E2	Metal Film Resistor	100Ω, 1/6W, 5%	07-20101-50	AXI.200X.080/.031
R1E3	Metal Film Resistor	100Ω, 1/6W, 5%	07-20101-50	AXI.200X.080/.031
R1E4	Metal Film Resistor	4K7Ω, 1/6W, 5%	07-20472-50	AXI.200X.080/.031
R1E5	Metal Film Resistor	1megΩ, 1/6W, 5%	07-20105-50	AXI.200X.080/.031
R1E6	Metal Film Resistor	1megΩ, 1/6W, 5%	07-20105-50	AXI.200X.080/.031
R1E8	Metal Film Resistor	2.2megΩ, 1/6W, 5%	07-20225-50	AXI.200X.080/.031
R1G1	Metal Oxide Film Resistor	100Ω, 2W, 5%	07-30101-12	AXI.800X.200/.037
R10D	Metal Film Resistor	470Ω, 1/6W, 5%	07-20471-50	AXI.200X.080/.031
R10E	Metal Film Resistor	75KΩ, 1/6W, 5%	07-20753-50	AXI.200X.080/.031
R10F	Metal Film Resistor	4K7Ω, 1/6W, 5%	07-20472-50	AXI.200X.080/.031
R10G	Metal Film Resistor	22KΩ, 1/6W, 5%	07-20223-50	AXI.200X.080/.031
R10H	Metal Film Resistor	22KΩ, 1/6W, 5%	07-20223-50	AXI.200X.080/.031
R10K	Metal Film Resistor	10KΩ, 1/6W, 5%	07-20103-50	AXI.200X.080/.031
R10M	Metal Film Resistor	10KΩ, 1/6W, 5%	07-20103-50	AXI.200X.080/.031
R10N	Metal Film Resistor	22KΩ, 1/6W, 5%	07-20223-50	AXI.200X.080/.031
R10P	Metal Film Resistor	100KΩ, 1/6W, 5%	07-20104-50	AXI.200X.080/.031
R10S	Metal Film Resistor	22KΩ, 1/6W, 5%	07-20223-50	AXI.200X.080/.031
R10T	Metal Film Resistor	100KΩ, 1/6W, 5%	07-20104-50	AXI.200X.080/.031

ELECTRICAL PARTS LIST

DESIGNATOR	DESCRIPTION	PART TYPE	PART NUMBER	FOOTPRINT
R10V	Metal Film Resistor	100KΩ, 1/6W, 5%	07-20104-50	AX/.200X.080/.031
CAPACITOR				
C102	Polyester capacitor	100nF, 10%, 63V	25-10461-00	RAD/.300X.150/LS.200/.035
C103	ALU Electrolytic Capacitor	100uF/25V, 20%, 105°C	06-10121-02	CPCYL1/D.300/LS.200/.031
C104	ALU Electrolytic Capacitor	10uF/50V, 20%, 105°C	06-10051-01	CPCYL1/D.200/LS.200/.031
C105	Polyester capacitor	10nF, 10%, 63V	25-10361-04	RAD/.300X.150/LS.200/.031
C106	Polyester capacitor	100nF, 10%, 63V	25-10461-00	RAD/.300X.150/LS.200/.035
C107	ALU Electrolytic Capacitor	100uF/25V, 20%, 105°C	06-10121-02	CPCYL1/D.300/LS.200/.031
C108	ALU Electrolytic Capacitor	10uF/50V, 20%, 105°C	06-10051-01	CPCYL1/D.200/LS.200/.031
C109	Polyester capacitor	10nF, 10%, 63V	25-10361-04	RAD/.300X.150/LS.200/.031
C112	Polyester capacitor	1.8nF, 10%, 50V	25-18251-00	RAD/.300X.150/LS.200/.031
C113	Ceramic Capacitor	470pF, 10%, 1KV	05-47113-00	CPAX/.200X.100/.038
C116	Ceramic Capacitor	470pF, 10%, 1KV	05-47113-00	CPAX/.200X.100/.038
C118	Ceramic Capacitor	15pF, 10%, 1KV	05-15013-00	CPAX/.200X.100/.031
C121	Ceramic Capacitor	68pF, 10%, 1KV	05-68013-00	CPAX/.200X.100/.034
C122	Ceramic Capacitor	68pF, 10%, 1KV	05-68013-00	CPAX/.200X.100/.034
C123	Polyester capacitor	100nF, 10%, 63V	25-10461-00	RAD/.300X.150/LS.200/.035
C124	ALU Electrolytic Capacitor	22uF/25V, 20%, 105°C	06-22021-01	CPCYL1/D.200/LS.200/.031
C125	ALU Electrolytic Capacitor	4.7uF/50V, 20%, 105°C	06-47951-05	CPCYL/D.200/LS.200/.031
C126	Polyester capacitor	22nF, 10%, 63V	25-22361-03	RAD/.300X.150/LS.200/.031
C129	Polyester capacitor	100nF, 5%, 250V	25-10422-01	RAD/.300X.150/LS.200/.034
C134	ALU Electrolytic Capacitor	1000uF/6.3V, 20%, 105°C	06-10260-01	CPCYL1/D.500/LS.200/.031
C135	Polyester capacitor	100nF, 10%, 63V	25-10461-00	RAD/.300X.150/LS.200/.035
C139	ALU Electrolytic Capacitor	10uF/100V, 20%, 105°C	06-10012-01	CPCYL1/D.300/LS.200/.031
C140	ALU Electrolytic Capacitor	10uF/100V, 20%, 105°C	06-10012-01	CPCYL1/D.300/LS.200/.031
C141	Polyester capacitor	100nF, 5%, 250V	25-10422-01	RAD/.300X.150/LS.200/.034
C142	Polyester capacitor	100nF, 5%, 250V	25-10422-01	RAD/.300X.150/LS.200/.034
C143	Polyester capacitor	100nF, 5%, 250V	25-10422-01	RAD/.300X.150/LS.200/.034
C144	Polyester capacitor	100nF, 5%, 250V	25-10422-01	RAD/.300X.150/LS.200/.034
C145	ALU Electrolytic Capacitor	100uF/16V, 20%, 105°C	06-10111-07	CPCYL1/D.300/LS.200/.031
C146	Polyester capacitor	100nF, 10%, 63V	25-10461-00	RAD/.300X.150/LS.200/.035
C147	Polyester capacitor	470nF, 10%, 63V	25-47461-01	RAD/.300X.150/LS.200/.036
C148	Polyester capacitor	470nF, 10%, 63V	25-47461-01	RAD/.300X.150/LS.200/.036
C150	Ceramic Capacitor	180pF, 10%, 1KV	05-18113-00	CPAX/.200X.100/.036
C151	Ceramic Capacitor	22pF, 5%, 1KV	05-22013-02	CPAX/.200X.100/.032
C152	Ceramic Capacitor	15pF, 5%, 1KV	05-15013-01	CPAX/.200X.100/.031
C153	Ceramic Capacitor	180pF, 10%, 1KV	05-18113-00	CPAX/.200X.100/.036
C154	Ceramic Capacitor	47pF, 5%, 1KV	05-47013-01	CPAX/.200X.100/.032
C155	Ceramic Capacitor	10pF, 5%, 1KV	05-10013-01	CPAX/.200X.100/.031
C156	Polyester capacitor	10nF, 10%, 63V	25-10361-04	RAD/.300X.150/LS.200/.031
C157	Ceramic Capacitor	22pF, 5%, 1KV	05-22013-02	CPAX/.200X.100/.032
C158	ALU Electrolytic Capacitor	100uF/16V, 20%, 105°C	06-10111-07	CPCYL1/D.300/LS.200/.031
C159	Polyester capacitor	100nF, 10%, 63V	25-10461-00	RAD/.300X.150/LS.200/.035
C160	Polyester capacitor	1nF, 5%, 63V	25-10261-00	RAD/.300X.100/LS.200/.031
C161	ALU Electrolytic Capacitor	1uF/50V, 20%, 105°C	06-10951-03	CPCYL/D.200/LS.200/.031
C162	ALU Electrolytic Capacitor	1uF/50V, 20%, 105°C	06-10951-03	CPCYL/D.200/LS.200/.031
C163	ALU Electrolytic Capacitor	1uF/50V, 20%, 105°C	06-10951-03	CPCYL/D.200/LS.200/.031
C164	ALU Electrolytic Capacitor	1uF/50V, 20%, 105°C	06-10951-03	CPCYL/D.200/LS.200/.031
C165	ALU Electrolytic Capacitor	1uF/50V, 20%, 105°C	06-10951-03	CPCYL/D.200/LS.200/.031
C166	ALU Electrolytic Capacitor	1uF/50V, 20%, 105°C	06-10951-03	CPCYL/D.200/LS.200/.031
C167	Polyester capacitor	1nF, 5%, 63V	25-10261-00	RAD/.300X.100/LS.200/.031
C168	Polyester capacitor	100nF, 10%, 63V	25-10461-00	RAD/.300X.150/LS.200/.035
C169	Ceramic Capacitor	22pF, 5%, 1KV	05-22013-02	CPAX/.200X.100/.032
C170	Polyester capacitor	1nF, 5%, 63V	25-10261-00	RAD/.300X.100/LS.200/.031
C171	ALU Electrolytic Capacitor	47uF/16V, 20%, 105°C	06-47011-00	CPCYL1/D.200/LS.200/.031
C172	ALU Electrolytic Capacitor	22uF/25V, 20%, 105°C	06-22021-01	CPCYL1/D.200/LS.200/.031
C173	ALU Electrolytic Capacitor	22uF/25V, 20%, 105°C	06-22021-01	CPCYL1/D.200/LS.200/.031
C174	Ceramic Capacitor	470pF, 10%, 1KV	05-47113-00	CPAX/.200X.100/.038
C180	Polyester capacitor	10nF, 5%, 250V	25-10322-02	RAD/.300X.150/LS.200/.033
C1G1	Ceramic Capacitor SMD	100nF, 10%, 50V	26-10451-11	SM/C_0805
CNI3	Ceramic Capacitor	22pF, 10%, 1KV	05-22013-00	CPAX/.200X.100/.032
CNI4	Ceramic Capacitor	22pF, 10%, 1KV	05-22013-00	CPAX/.200X.100/.032
CNI5	Ceramic Capacitor	47pF, 10%, 1KV	05-47013-00	CPAX/.200X.100/.032
CNI6	Ceramic Capacitor	47pF, 10%, 1KV	05-47013-00	CPAX/.200X.100/.032
INDUCTOR				
Q125	FERRIT TOROID	φ5×φ3×5	19-05005-00	
Q126	FERRIT TOROID	φ5×φ3×5	19-05005-00	
Q127	FERRIT TOROID	φ5×φ3×5	19-05005-00	
Q128	FERRIT TOROID	φ5×φ3×5	19-05005-00	

ELECTRICAL PARTS LIST

DESIGNATOR	DESCRIPTION	PART TYPE	PART NUMBER	FOOTPRINT
L101	Inductor	0.7uH, horizontal type	08-01079-01	RAD/.850X.450/LS.700/.059
RELAY				
RL101	RELAYS	JQX-115F/024/1HS1	12-03101-03	RELAY_1
POT				
RV101	POT	5K, RK09K1110482-5KA	09-01502-00	VPOT1
RV102	SEMI POT	300Ω, vertical type	09-02301-01	VRES17
RV103	SEMI POT	500Ω, vertical type	09-02501-02	VRES17
RV104	SEMI POT	100K, vertical type	09-02104-01	VRES17
FUSE				
F101	FUSE	T6.3AL/250V	20-12632-00	5X20
F102	FUSE	T6.3AL/250V	20-12632-00	5X20
FUSE HOLDER				
F101	FUSE HOLDER	LS-PTF-78 (CQ-200C)	20-20000-06	RAD/.1000X.400/LS.850/.066
F102	FUSE HOLDER	LS-PTF-78 (CQ-200C)	20-20000-06	RAD/.1000X.400/LS.850/.066
CONNECTOR				
P101A	CONNECTOR	9PIN	13-13909-00	
P102A	CONNECTOR	9PIN	13-13909-00	
P103A	CONNECTOR	6PIN2.54弯脚	13-12506-02	
J101	RCA	AV-8.4-14, white	17-01001-10	RCA_1A
J102	Binding Post	Binding Post	02-03003-10	
G1G1	Ground Solder Tap	GND-8	32-28042-00	
JUMPER				
W101	JUMPER	5mm光线	21-06000-00	
BUS101	BUSBAR	HS4-T972-B009V1-M015	69-010001-0	
P/N 01-97302-00 PCB2 BOARD (POWER SUPPLY)				
DIODE				
D201	Switch Diode	1N4148	33-44148-00	DAX/.300X.080/.031
D202	Switch Diode	1N4148	33-44148-00	DAX/.300X.080/.031
D203	Switch Diode	1N4148	33-44148-00	DAX/.300X.080/.031
D204	Switch Diode	1N4148	33-44148-00	DAX/.300X.080/.031
D205	Switch Diode	1N4148	33-44148-00	DAX/.300X.080/.031
D206	RECTIFY DIODES	1N4007	33-24007-00	DAX1/1N-4001-4007
D207	Switch Diode	1N4148	33-44148-00	DAX/.300X.080/.031
D208	Switch Diode	1N4148	33-44148-00	DAX/.300X.080/.031
D209	Switch Diode	1N4148	33-44148-00	DAX/.300X.080/.031
D210	Zener Diode	8.2V, 1/2W	33-18209-00	DAX/.300X.080/.031
D211	Zener Diode	8.2V, 1/2W	33-18209-00	DAX/.300X.080/.031
D212	Zener Diode	5.1V, 1/2W	33-15109-00	DAX/.300X.080/.031
D213	Zener Diode	4.3V, 1/2W	33-14309-00	DAX/.300X.080/.031
D214	Zener Diode	4.3V, 1/2W	33-14309-00	DAX/.300X.080/.031
D215	Zener Diode	4.3V, 1/2W	33-14309-00	DAX/.300X.080/.031
D216	Zener Diode	4.3V, 1/2W	33-14309-00	DAX/.300X.080/.031
D217	Zener Diode	4.3V, 1/2W	33-14309-00	DAX/.300X.080/.031
D218	Zener Diode	4.3V, 1/2W	33-14309-00	DAX/.300X.080/.031
D219	Zener Diode	4.3V, 1/2W	33-14309-00	DAX/.300X.080/.031
D220	Zener Diode	6.8V, 1/2W	33-16809-00	DAX/.300X.080/.031
D221	Zener Diode	6.8V, 1/2W	33-16809-00	DAX/.300X.080/.031
D222	Zener Diode	6.8V, 1/2W	33-16809-00	DAX/.300X.080/.031
D223	Switch Diode	1N4148	33-44148-00	DAX/.300X.080/.031
D224	Switch Diode	1N4148	33-44148-00	DAX/.300X.080/.031
D225	Switch Diode	1N4148	33-44148-00	DAX/.300X.080/.031
D226	Switch Diode	1N4148	33-44148-00	DAX/.300X.080/.031
D227	Switch Diode	1N4148	33-44148-00	DAX/.300X.080/.031
D228	Switch Diode	1N4148	33-44148-00	DAX/.300X.080/.031
D229	Switch Diode	1N4148	33-44148-00	DAX/.300X.080/.031
D230	Switch Diode	1N4148	33-44148-00	DAX/.300X.080/.031
D231	Switch Diode	1N4148	33-44148-00	DAX/.300X.080/.031
D232	LED	φ3, GREEN	33-50350-00	DYL/D.200/LS.100/.039
D233	Switch Diode	1N4148	33-44148-00	DAX/.300X.080/.031
D234	Switch Diode	1N4148	33-44148-00	DAX/.300X.080/.031
D235	Zener Diode	3.3V, 1/2W	33-13309-00	DAX/.300X.080/.031
D236	Zener Diode	3.3V, 1/2W	33-13309-00	DAX/.300X.080/.031
D237	Zener Diode	13V, 1/2W	33-11300-00	DAX/.300X.080/.031
BRIDGE				
BR201	BRIDGE	DB104G	33-30142-00	BRIDGE/.400X.500/.051
BR202	BRIDGE	DB104G	33-30142-00	BRIDGE/.400X.500/.051
BR203	BRIDGE	DB104G	33-30142-00	BRIDGE/.400X.500/.051
BR204	BRIDGE	KBJ2506	33-32562-00	BRIDGE/1.180X.180/.087

ELECTRICAL PARTS LIST

DESIGNATOR	DESCRIPTION	PART TYPE	PART NUMBER	FOOTPRINT
BR205	BRIDGE	KBJ2506	33-32562-00	BRIDGE/1.180X.180/.087
BR206	BRIDGE	KBJ2506	33-32562-00	BRIDGE/1.180X.180/.087
BR207	BRIDGE	KBJ2506	33-32562-00	BRIDGE/1.180X.180/.087
BR208	BRIDGE	DB104G	33-30142-00	BRIDGE/400X.500/.051
TRANSISTOR				
Q201	Transistor	KSA1220AYSTU	31-01220-00	TO126/90/ECB
Q202	Transistor	KSC2690AYSTU	31-02690-00	TO126/90/ECB
Q203	Transistor	2SC1815-GR	31-01815-00	TO92/100/ECB
Q204	Transistor	2SA1015-GR	31-01015-00	TO92/100/ECB
Q205	Transistor	2SC4793	31-04793-00	TO220AB/BCE
Q205	Transistor	KTD2061-Y	31-02061-00	TO220AB/BCE
Q206	Transistor	2SA1837	31-01837-00	TO220AB/BCE
Q206	Transistor	KTB1369-Y	31-01369-00	TO220AB/BCE
Q207	Transistor	2SC2240-GR	31-02240-00	TO92/100/ECB
Q208	Transistor	2SC2240-GR	31-02240-00	TO92/100/ECB
Q209	Transistor	2SA970-GR	31-00970-00	TO92/100/ECB
Q210	Transistor	2SC1815-GR	31-01815-00	TO92/100/ECB
Q211	Transistor	2SA1015-GR	31-01015-00	TO92/100/ECB
Q212	Transistor	2SB647-AWC	31-00647-00	TO92/100/ECB
Q213	Transistor	2SD667-AWC	31-00667-00	TO92/100/ECB
Q214	Transistor	2SC1815-GR	31-01815-00	TO92/100/ECB
Q215	Transistor	2SA1015-GR	31-01015-00	TO92/100/ECB
Q216	Transistor	2SB647-AWC	31-00647-00	TO92/100/ECB
Q217	Transistor	2SD667-AWC	31-00667-00	TO92/100/ECB
Q218	Transistor	KSC2690AYSTU	31-02690-00	TO126/90/ECB
Q219	Transistor	KSC2690AYSTU	31-02690-00	TO126/90/ECB
Q220	Transistor	KSC2690AYSTU	31-02690-00	TO126/90/ECB
Q221	Transistor	2SC1815-GR	31-01815-00	TO92/100/ECB
Q222	Transistor	2SC1815-GR	31-01815-00	TO92/100/ECB
Q223	Transistor	2SC1815-GR	31-01815-00	TO92/100/ECB
Q224	Transistor	2SC1815-GR	31-01815-00	TO92/100/ECB
Q225	Transistor	2SC1815-GR	31-01815-00	TO92/100/ECB
Q226	Transistor	2SC1815-GR	31-01815-00	TO92/100/ECB
Q227	Transistor	2SD667-AWC	31-00667-00	TO92/100/ECB
Q228	Transistor	2SC1815-GR	31-01815-00	TO92/100/ECB
Q229	Transistor	2SC1815-GR	31-01815-00	TO92/100/ECB
Q230	Transistor	2SC1815-GR	31-01815-00	TO92/100/ECB
Q231	Transistor	2SC1815-GR	31-01815-00	TO92/100/ECB
Q232	Transistor	2SC1815-GR	31-01815-00	TO92/100/ECB
Q233	Transistor	2SC1815-GR	31-01815-00	TO92/100/ECB
Q234	Transistor	2SC2240-GR	31-02240-00	TO92/100/ECB
Q235	Transistor	2SA970-GR	31-00970-00	TO92/100/ECB
Q236	SCR	30TPS12PBF	33-83008-00	TO247AC
Q237	SCR	30TPS12PBF	33-83008-00	TO247AC
Q238	SCR	30TPS12PBF	33-83008-00	TO247AC
Q239	SCR	30TPS12PBF	33-83008-00	TO247AC
Q240	Transistor	2SC1815-GR	31-01815-00	TO92/100/ECB
Q241	Transistor	2SC1815-GR	31-01815-00	TO92/100/ECB
Q242	Transistor	2SA1015-GR	31-01015-00	TO92/100/ECB
IC				
IC201	RAGULATOR	L7812CT	03-07812-00	TO220AB/123
IC202	RAGULATOR	L7912CT	03-07912-00	TO220AB/123
IC203	QUAD OP-AMP	TL084CN	03-00084-00	DIP.100/14/W.300/L.750
IC204	GATE IC	SN74HC21N	03-07421-00	DIP.100/14/W.300/L.750
IC205	RAGULATOR	L7805CT	03-07805-00	TO220AB/123
IC206	DUAL OP-AMP	TL082CP	03-00082-00	DIP.100/8/W.300/L.750
RESISTOR				
R201	Metal Film Resistor	1KΩ, 1/6W, 5%	07-20102-50	AX/.200X.080/.031
R202	Metal Film Resistor	1KΩ, 1/6W, 5%	07-20102-50	AX/.200X.080/.031
R203	Metal Film Resistor	2K2Ω, 1/6W, 5%	07-20222-50	AX/.200X.080/.031
R204	Metal Film Resistor	2K2Ω, 1/6W, 5%	07-20222-50	AX/.200X.080/.031
R205	Metal Film Resistor	100Ω, 1/6W, 5%	07-20101-50	AX/.200X.080/.031
R206	Metal Film Resistor	100Ω, 1/6W, 5%	07-20101-50	AX/.200X.080/.031
R207	Metal Film Resistor	1K5Ω, 1/6W, 5%	07-20152-50	AX/.200X.080/.031
R208	Metal Film Resistor	1K5Ω, 1/6W, 5%	07-20152-50	AX/.200X.080/.031
R209	Metal Film Resistor	10KΩ, 1/6W, 5%	07-20103-50	AX/.200X.080/.031
R210	Metal Film Resistor	2KΩ, 1/6W, 5%	07-20202-50	AX/.200X.080/.031
R211	Metal Film Resistor	470Ω, 1/6W, 5%	07-20471-50	AX/.200X.080/.031
R212	Metal Film Resistor	470Ω, 1/6W, 5%	07-20471-50	AX/.200X.080/.031

ELECTRICAL PARTS LIST

DESIGNATOR	DESCRIPTION	PART TYPE	PART NUMBER	FOOTPRINT
R213	Metal Oxide Film Resistor	10Ω, 1/2W, 5%	07-30100-03	AXI.600X.125/.039
R214	Metal Film Resistor	1K8Ω, 1/6W, 5%	07-20182-50	AXI.200X.080/.031
R215	Metal Film Resistor	1K8Ω, 1/6W, 5%	07-20182-50	AXI.200X.080/.031
R216	Metal Film Resistor	1K8Ω, 1/6W, 5%	07-20182-50	AXI.200X.080/.031
R217	Metal Film Resistor	220Ω, 1/6W, 5%	07-20221-50	AXI.200X.080/.031
R218	Metal Film Resistor	2K2Ω, 1/6W, 5%	07-20222-50	AXI.200X.080/.031
R219	Metal Film Resistor	220Ω, 1/6W, 5%	07-20221-50	AXI.200X.080/.031
R220	Metal Film Resistor	10K2Ω, 1/6W, 1%	07-21022-50	AXI.200X.080/.031
R221	Metal Film Resistor	2K1Ω, 1/6W, 1%	07-22101-50	AXI.200X.080/.031
R222	Metal Film Resistor	1K8Ω, 1/6W, 5%	07-20182-50	AXI.200X.080/.031
R223	Metal Film Resistor	1K8Ω, 1/6W, 5%	07-20182-50	AXI.200X.080/.031
R224	Metal Oxide Film Resistor	10Ω, 1/2W, 5%	07-30100-03	AXI.600X.125/.039
R225	Metal Film Resistor	1K8Ω, 1/6W, 5%	07-20182-50	AXI.200X.080/.031
R226	Metal Film Resistor	220Ω, 1/6W, 5%	07-20221-50	AXI.200X.080/.031
R227	Metal Film Resistor	12KΩ, 1/6W, 1%	07-21202-50	AXI.200X.080/.031
R228	Metal Film Resistor	15KΩ, 1/4W, 5%	07-20153-51	AXI.400X.080/.031
R229	Metal Film Resistor	4K7Ω, 1/4W, 5%	07-20472-51	AXI.400X.080/.031
R230	Metal Film Resistor	1KΩ, 1/6W, 5%	07-20102-50	AXI.200X.080/.031
R231	Metal Film Resistor	10KΩ, 1/6W, 5%	07-20103-50	AXI.200X.080/.031
R232	Metal Film Resistor	10KΩ, 1/6W, 5%	07-20103-50	AXI.200X.080/.031
R233	Metal Oxide Film Resistor	10KΩ, 1/2W, 5%	07-30103-00	AXI.400X.100/.031
R234	Metal Oxide Film Resistor	10KΩ, 1/2W, 5%	07-30103-00	AXI.400X.100/.031
R235	Metal Film Resistor	1KΩ, 1/6W, 5%	07-20102-50	AXI.200X.080/.031
R236	Metal Film Resistor	1KΩ, 1/6W, 5%	07-20102-50	AXI.200X.080/.031
R237	Metal Film Resistor	1KΩ, 1/6W, 5%	07-20102-50	AXI.200X.080/.031
R238	Metal Oxide Film Resistor	47Ω, 1/2W, 5%	07-30470-00	AXI.400X.080/.031
R239	Metal Film Resistor	1KΩ, 1/6W, 5%	07-20102-50	AXI.200X.080/.031
R240	Metal Oxide Film Resistor	47Ω, 1/2W, 5%	07-30470-00	AXI.400X.080/.031
R241	Metal Film Resistor	10KΩ, 1/6W, 5%	07-20103-50	AXI.200X.080/.031
R242	Metal Oxide Film Resistor	10KΩ, 1/2W, 5%	07-30103-00	AXI.400X.100/.031
R243	Metal Oxide Film Resistor	10KΩ, 1/2W, 5%	07-30103-00	AXI.400X.100/.031
R244	Metal Film Resistor	1KΩ, 1/6W, 5%	07-20102-50	AXI.200X.080/.031
R245	Metal Film Resistor	1KΩ, 1/6W, 5%	07-20102-50	AXI.200X.080/.031
R246	Metal Film Resistor	1KΩ, 1/6W, 5%	07-20102-50	AXI.200X.080/.031
R247	Metal Oxide Film Resistor	47Ω, 1/2W, 5%	07-30470-00	AXI.400X.080/.031
R248	Metal Film Resistor	1KΩ, 1/6W, 5%	07-20102-50	AXI.200X.080/.031
R249	Metal Oxide Film Resistor	47Ω, 1/2W, 5%	07-30470-00	AXI.400X.080/.031
R250	Metal Film Resistor	470Ω, 1/6W, 5%	07-20471-50	AXI.200X.080/.031
R251	Metal Film Resistor	1KΩ, 1/6W, 5%	07-20102-50	AXI.200X.080/.031
R252	Metal Film Resistor	100KΩ, 1/6W, 5%	07-20104-50	AXI.200X.080/.031
R253	Metal Film Resistor	1KΩ, 1/6W, 5%	07-20102-50	AXI.200X.080/.031
R254	Metal Film Resistor	470Ω, 1/6W, 5%	07-20471-50	AXI.200X.080/.031
R255	Metal Film Resistor	1KΩ, 1/6W, 5%	07-20102-50	AXI.200X.080/.031
R256	Metal Film Resistor	10KΩ, 1/6W, 5%	07-20103-50	AXI.200X.080/.031
R257	Metal Film Resistor	1KΩ, 1/6W, 5%	07-20102-50	AXI.200X.080/.031
R258	Metal Film Resistor	10KΩ, 1/6W, 5%	07-20103-50	AXI.200X.080/.031
R259	Metal Film Resistor	100Ω, 1/6W, 5%	07-20101-50	AXI.200X.080/.031
R260	Metal Film Resistor	2KΩ, 1/6W, 5%	07-20202-50	AXI.200X.080/.031
R261	Metal Film Resistor	10KΩ, 1/6W, 1%	07-21002-50	AXI.200X.080/.031
R262	Metal Film Resistor	10KΩ, 1/6W, 1%	07-21002-50	AXI.200X.080/.031
R263	Metal Film Resistor	10KΩ, 1/6W, 1%	07-21002-50	AXI.200X.080/.031
R264	Metal Film Resistor	10KΩ, 1/6W, 1%	07-21002-50	AXI.200X.080/.031
R265	Metal Film Resistor	10KΩ, 1/6W, 1%	07-21002-50	AXI.200X.080/.031
R266	Metal Film Resistor	10KΩ, 1/6W, 1%	07-21002-50	AXI.200X.080/.031
R267	Metal Film Resistor	10KΩ, 1/6W, 1%	07-21002-50	AXI.200X.080/.031
R268	Metal Film Resistor	10KΩ, 1/6W, 1%	07-21002-50	AXI.200X.080/.031
R269	Metal Film Resistor	10KΩ, 1/6W, 1%	07-21002-50	AXI.200X.080/.031
R270	Metal Film Resistor	43KΩ, 1/6W, 1%	07-24302-50	AXI.200X.080/.031
R271	Metal Film Resistor	43KΩ, 1/6W, 1%	07-24302-50	AXI.200X.080/.031
R272	Metal Film Resistor	43KΩ, 1/6W, 1%	07-24302-50	AXI.200X.080/.031
R273	Metal Film Resistor	100Ω, 1/6W, 5%	07-20101-50	AXI.200X.080/.031
R274	Metal Film Resistor	100Ω, 1/6W, 5%	07-20101-50	AXI.200X.080/.031
R275	Metal Film Resistor	100Ω, 1/6W, 5%	07-20101-50	AXI.200X.080/.031
R276	Metal Film Resistor	3K3Ω, 1/6W, 5%	07-20332-50	AXI.200X.080/.031
R277	Metal Film Resistor	3K3Ω, 1/6W, 5%	07-20332-50	AXI.200X.080/.031
R278	Metal Film Resistor	3K3Ω, 1/6W, 5%	07-20332-50	AXI.200X.080/.031
R279	Metal Film Resistor	3K3Ω, 1/6W, 5%	07-20332-50	AXI.200X.080/.031
R280	Metal Film Resistor	10KΩ, 1/6W, 5%	07-20103-50	AXI.200X.080/.031
R281	Metal Film Resistor	10KΩ, 1/6W, 5%	07-20103-50	AXI.200X.080/.031
R282	Metal Film Resistor	10KΩ, 1/6W, 5%	07-20103-50	AXI.200X.080/.031

ELECTRICAL PARTS LIST

DESIGNATOR	DESCRIPTION	PART TYPE	PART NUMBER	FOOTPRINT
R283	Metal Film Resistor	10K Ω , 1/6W, 5%	07-20103-50	AXI.200X.080/031
R284	Metal Film Resistor	10K Ω , 1/6W, 5%	07-20103-50	AXI.200X.080/031
R285	Metal Film Resistor	10K Ω , 1/6W, 5%	07-20103-50	AXI.200X.080/031
R286	Metal Film Resistor	10K Ω , 1/6W, 5%	07-20103-50	AXI.200X.080/031
R287	Metal Film Resistor	10K Ω , 1/6W, 5%	07-20103-50	AXI.200X.080/031
R288	Metal Film Resistor	10K Ω , 1/6W, 5%	07-20103-50	AXI.200X.080/031
R289	Metal Film Resistor	10K Ω , 1/6W, 5%	07-20103-50	AXI.200X.080/031
R290	Metal Film Resistor	10K Ω , 1/6W, 5%	07-20103-50	AXI.200X.080/031
R291	Metal Film Resistor	1K Ω , 1/6W, 5%	07-20102-50	AXI.200X.080/031
R292	Metal Film Resistor	10K Ω , 1/6W, 5%	07-20103-50	AXI.200X.080/031
R293	Metal Film Resistor	10K Ω , 1/6W, 5%	07-20103-50	AXI.200X.080/031
R294	Metal Film Resistor	10K Ω , 1/6W, 5%	07-20103-50	AXI.200X.080/031
R295	Metal Film Resistor	10K Ω , 1/6W, 5%	07-20103-50	AXI.200X.080/031
R296	Metal Film Resistor	10K Ω , 1/6W, 5%	07-20103-50	AXI.200X.080/031
R297	Metal Film Resistor	10K Ω , 1/6W, 5%	07-20103-50	AXI.200X.080/031
R298	Metal Film Resistor	10K Ω , 1/6W, 5%	07-20103-50	AXI.200X.080/031
R299	Metal Film Resistor	100 Ω , 1/6W, 5%	07-20101-50	AXI.200X.080/031
R2A1	Metal Film Resistor	10 Ω , 1/6W, 5%	07-20100-50	AXI.200X.080/031
R2A2	Metal Film Resistor	10 Ω , 1/6W, 5%	07-20100-50	AXI.200X.080/031
R2A3	Metal Film Resistor	10 Ω , 1/6W, 5%	07-20100-50	AXI.200X.080/031
R2A4	Metal Film Resistor	10K Ω , 1/6W, 1%	07-21002-50	AXI.200X.080/031
R2A5	Metal Film Resistor	10K Ω , 1/6W, 1%	07-21002-50	AXI.200X.080/031
R2A6	Metal Film Resistor	10K Ω , 1/6W, 1%	07-21002-50	AXI.200X.080/031
R2A7	Metal Film Resistor	10K Ω , 1/6W, 1%	07-21002-50	AXI.200X.080/031
R2A8	Metal Film Resistor	10K Ω , 1/6W, 1%	07-21002-50	AXI.200X.080/031
R2A9	Metal Film Resistor	10K Ω , 1/6W, 1%	07-21002-50	AXI.200X.080/031
R2E1	Metal Film Resistor	1K Ω , 1/6W, 5%	07-20102-50	AXI.200X.080/031
R2E2	Metal Film Resistor	10K Ω , 1/6W, 5%	07-20103-50	AXI.200X.080/031
R2E3	Metal Film Resistor	180 Ω , 1/6W, 5%	07-20181-50	AXI.200X.080/031
R2E4	Metal Film Resistor	1K Ω , 1/6W, 5%	07-20102-50	AXI.200X.080/031
R2E5	Metal Film Resistor	100K Ω , 1/6W, 5%	07-20104-50	AXI.200X.080/031
R2E6	Metal Film Resistor	1K Ω , 1/6W, 5%	07-20102-50	AXI.200X.080/031
R2E7	Metal Film Resistor	1K Ω , 1/6W, 5%	07-20102-50	AXI.200X.080/031
R2E8	Metal Film Resistor	10K Ω , 1/6W, 5%	07-20103-50	AXI.200X.080/031
R2E9	Metal Film Resistor	20K Ω , 1/6W, 5%	07-20203-50	AXI.200X.080/031
R2F1	Metal Film Resistor	10K Ω , 1/6W, 5%	07-20103-50	AXI.200X.080/031
R2F2	Metal Film Resistor	20K Ω , 1/6W, 5%	07-20203-50	AXI.200X.080/031
R2F3	Metal Film Resistor	10K Ω , 1/6W, 5%	07-20103-50	AXI.200X.080/031
R2F4	Metal Film Resistor	10K Ω , 1/6W, 5%	07-20103-50	AXI.200X.080/031
R2F5	Link	L=5mm	21-06000-00	AXI.200X.080/031
R2F7	Metal Film Resistor	10K Ω , 1/6W, 5%	07-20103-50	AXI.200X.080/031
R2F8	Metal Film Resistor	560 Ω , 1/6W, 5%	07-20561-50	AXI.200X.080/031
R2H2	Metal Film Resistor	10K Ω , 1/6W, 5%	07-20103-50	AXI.200X.080/031
R2H3	Metal Film Resistor	10K Ω , 1/6W, 5%	07-20103-50	AXI.200X.080/031
R2H4	Metal Film Resistor	10K Ω , 1/6W, 5%	07-20103-50	AXI.200X.080/031
CAPACITOR				
C201	Polyester capacitor	10nF, 10%, 100V	25-10312-01	RAD/.300X.150/LS.200/035
C202	ALU Electrolytic Capacitor	3300uF/35V, 20%, 105 $^{\circ}$ C	06-33231-00	CPCYL1/D.900/LS.400/062
C203	ALU Electrolytic Capacitor	3300uF/35V, 20%, 105 $^{\circ}$ C	06-33231-00	CPCYL1/D.900/LS.400/062
C204	Polyester capacitor	10nF, 10%, 100V	25-10312-01	RAD/.300X.150/LS.200/035
C205	Polyester capacitor	10nF, 10%, 100V	25-10312-01	RAD/.300X.150/LS.200/035
C206	Polyester capacitor	100nF, 10%, 100V	25-10412-02	RAD/.300X.150/LS.200/037
C207	Polyester capacitor	100nF, 10%, 100V	25-10412-02	RAD/.300X.150/LS.200/037
C208	ALU Electrolytic Capacitor	10uF/50V, 20%, 105 $^{\circ}$ C	06-10051-01	CPCYL1/D.200/LS.200/031
C209	ALU Electrolytic Capacitor	10uF/50V, 20%, 105 $^{\circ}$ C	06-10051-01	CPCYL1/D.200/LS.200/031
C210	Polyester capacitor	10nF, 10%, 100V	25-10312-01	RAD/.300X.150/LS.200/035
C211	Polyester capacitor	10nF, 10%, 100V	25-10312-01	RAD/.300X.150/LS.200/035
C212	Polyester capacitor	10nF, 10%, 100V	25-10312-01	RAD/.300X.150/LS.200/035
C213	ALU Electrolytic Capacitor	3900uF/25V, 20%, 105 $^{\circ}$ C	06-39221-00	CPCYL1/D.900/LS.400/062
C213	ALU Electrolytic Capacitor	3300uF/35V, 20%, 105 $^{\circ}$ C	06-33231-00	CPCYL1/D.900/LS.400/062
C214	ALU Electrolytic Capacitor	3900uF/25V, 20%, 105 $^{\circ}$ C	06-39221-00	CPCYL1/D.900/LS.400/062
C214	ALU Electrolytic Capacitor	3300uF/35V, 20%, 105 $^{\circ}$ C	06-33231-00	CPCYL1/D.900/LS.400/062
C215	ALU Electrolytic Capacitor	100uF/35V, 20%, 105 $^{\circ}$ C	06-10131-05	CPCYL1/D.300/LS.200/031
C216	ALU Electrolytic Capacitor	100uF/35V, 20%, 105 $^{\circ}$ C	06-10131-05	CPCYL1/D.300/LS.200/031
C217	ALU Electrolytic Capacitor	47uF/25V, 20%, 105 $^{\circ}$ C	06-47021-01	CPCYL1/D.300/LS.200/031
C218	ALU Electrolytic Capacitor	47uF/25V, 20%, 105 $^{\circ}$ C	06-47021-01	CPCYL1/D.300/LS.200/031
C219	Polyester capacitor	10nF, 10%, 100V	25-10312-01	RAD/.300X.150/LS.200/035
C220	Polyester capacitor	10nF, 10%, 100V	25-10312-01	RAD/.300X.150/LS.200/035
C221	Polyester capacitor	10nF, 10%, 250V	25-10322-01	RAD/.300X.150/LS.200/036

ELECTRICAL PARTS LIST

DESIGNATOR	DESCRIPTION	PART TYPE	PART NUMBER	FOOTPRINT
C222	Polyester capacitor	10nF, 10%, 250V	25-10322-01	RAD/.300X.150/LS.200/.036
C223	Polyester capacitor	10nF, 10%, 250V	25-10322-01	RAD/.300X.150/LS.200/.036
C224	ALU Electrolytic Capacitor	1000uF/80V, 20%, 105°C	06-10281-01	CPCYL1/D.900/LS.400/.062
C225	ALU Electrolytic Capacitor	1000uF/80V, 20%, 105°C	06-10281-01	CPCYL1/D.900/LS.400/.062
C226	ALU Electrolytic Capacitor	10uF/50V, 20%, 105°C	06-10051-01	CPCYL1/D.200/LS.200/.031
C227	ALU Electrolytic Capacitor	47uF/100V, 20%, 105°C	06-47012-01	CPCYL1/D.300/LS.200/.031
C228	ALU Electrolytic Capacitor	100uF/35V, 20%, 105°C	06-10131-05	CPCYL1/D.300/LS.200/.031
C229	Polyester capacitor	100nF, 10%, 100V	25-10412-02	RAD/.300X.150/LS.200/.037
C230	Ceramic Capacitor	47pF, 10%, 1KV	05-47013-00	CPAX/.200X.100/.036
C231	ALU Electrolytic Capacitor	10uF/100V, 20%, 105°C	06-10012-01	CPCYL1/D.200/LS.200/.031
C232	ALU Electrolytic Capacitor	47uF/100V, 20%, 105°C	06-47012-01	CPCYL1/D.300/LS.200/.031
C233	ALU Electrolytic Capacitor	100uF/35V, 20%, 105°C	06-10131-05	CPCYL1/D.300/LS.200/.031
C234	Ceramic Capacitor	47pF, 10%, 1KV	05-47013-00	CPAX/.200X.100/.036
C235	ALU Electrolytic Capacitor	10uF/100V, 20%, 105°C	06-10012-01	CPCYL1/D.200/LS.200/.031
C236	Polyester capacitor	100nF, 10%, 100V	25-10412-02	RAD/.300X.150/LS.200/.037
C237	Polyester capacitor	100nF, 10%, 100V	25-10412-02	RAD/.300X.150/LS.200/.037
C238	ALU Electrolytic Capacitor	10uF/100V, 20%, 105°C	06-10012-01	CPCYL1/D.200/LS.200/.031
C239	ALU Electrolytic Capacitor	10uF/100V, 20%, 105°C	06-10012-01	CPCYL1/D.200/LS.200/.031
C240	ALU Electrolytic Capacitor	10uF/100V, 20%, 105°C	06-10012-01	CPCYL1/D.200/LS.200/.031
C241	Polyester capacitor	10nF, 10%, 250V	25-10322-01	RAD/.300X.150/LS.200/.036
C242	Polyester capacitor	10nF, 10%, 250V	25-10322-01	RAD/.300X.150/LS.200/.036
C243	Polyester capacitor	2.2nF, 10%, 250V	25-22222-00	RAD/.300X.150/LS.200/.034
C244	Polyester capacitor	2.2nF, 10%, 250V	25-22222-00	RAD/.300X.150/LS.200/.034
C245	Polyester capacitor	2.2nF, 10%, 250V	25-22222-00	RAD/.300X.150/LS.200/.034
C246	Polyester capacitor	2.2nF, 10%, 250V	25-22222-00	RAD/.300X.150/LS.200/.034
C247	ALU Electrolytic Capacitor	15000uF/80V, 105°C	06-15381-00	CPCYL1/D1.420/LS.880/.079
C248	ALU Electrolytic Capacitor	15000uF/80V, 105°C	06-15381-00	CPCYL1/D1.420/LS.880/.079
C249	Polyester capacitor	2.2nF, 10%, 250V	25-22222-00	RAD/.300X.150/LS.200/.034
C250	Polyester capacitor	2.2nF, 10%, 250V	25-22222-00	RAD/.300X.150/LS.200/.034
C251	Polyester capacitor	2.2nF, 10%, 250V	25-22222-00	RAD/.300X.150/LS.200/.034
C252	Polyester capacitor	2.2nF, 10%, 250V	25-22222-00	RAD/.300X.150/LS.200/.034
C253	ALU Electrolytic Capacitor	22000uF/80V, 105°C	06-22381-00	CPCYL1/D1.420/LS.880/.079
C254	ALU Electrolytic Capacitor	22000uF/80V, 105°C	06-22381-00	CPCYL1/D1.420/LS.880/.079
C255	ALU Electrolytic Capacitor	1500uF/50V, 20%, 105°C	06-15251-00	CPCYL1/D.900/LS.400/.062
C255	ALU Electrolytic Capacitor	2200uF/25V, 20%, 105°C	06-22221-04	CPCYL1/D.900/LS.350/.062
C256	Polyester capacitor	10nF, 10%, 100V	25-10312-01	RAD/.300X.150/LS.200/.035
C257	Polyester capacitor	100nF, 10%, 100V	25-10412-02	RAD/.300X.150/LS.200/.037
C258	Polyester capacitor	10nF, 10%, 100V	25-10312-01	RAD/.300X.150/LS.200/.035
C259	ALU Electrolytic Capacitor	1uF/50V, 20%, 105°C	06-10951-10	CPCYL1/D.200/LS.200/.031
C260	ALU Electrolytic Capacitor	1uF/50V, 20%, 105°C	06-10951-10	CPCYL1/D.200/LS.200/.031
C261	ALU Electrolytic Capacitor	1uF/50V, 20%, 105°C	06-10951-10	CPCYL1/D.200/LS.200/.031
C262	Ceramic Capacitor	220pF, 10%, 1KV	05-22113-01	CPAX/.200X.100/.036
C264	ALU Electrolytic Capacitor	100uF/16V, 20%, 105°C	06-10111-07	CPCYL1/D.200/LS.200/.031
C271	Polyester capacitor	100nF, 10%, 100V	25-10412-02	RAD/.300X.150/LS.200/.037
C272	Polyester capacitor	100nF, 10%, 100V	25-10412-02	RAD/.300X.150/LS.200/.037
C273	Polyester capacitor	100nF, 10%, 100V	25-10412-02	RAD/.300X.150/LS.200/.037
C274	Polyester capacitor	100nF, 10%, 100V	25-10412-02	RAD/.300X.150/LS.200/.037
C275	Polyester capacitor	100nF, 10%, 100V	25-10412-02	RAD/.300X.150/LS.200/.037
C276	ALU Electrolytic Capacitor	10uF/50V, 20%, 105°C	06-10051-01	CPCYL1/D.200/LS.200/.031
C277	ALU Electrolytic Capacitor	10uF/50V, 20%, 105°C	06-10051-01	CPCYL1/D.200/LS.200/.031
C278	ALU Electrolytic Capacitor	10uF/50V, 20%, 105°C	06-10051-01	CPCYL1/D.200/LS.200/.031
C279	ALU Electrolytic Capacitor	10uF/50V, 20%, 105°C	06-10051-01	CPCYL1/D.200/LS.200/.031
C280	Polyester capacitor	100nF, 10%, 100V	25-10412-02	RAD/.300X.150/LS.200/.037
C281	Polyester capacitor	100nF, 10%, 100V	25-10412-02	RAD/.300X.150/LS.200/.037
C282	Polyester capacitor	100nF, 10%, 100V	25-10412-02	RAD/.300X.150/LS.200/.037
C283	ALU Electrolytic Capacitor	10uF/50V, 20%, 105°C	06-10051-01	CPCYL1/D.200/LS.200/.031
C284	ALU Electrolytic Capacitor	10uF/50V, 20%, 105°C	06-10051-01	CPCYL1/D.200/LS.200/.031
POT				
RV201	SEMI POT	1K, vertical type	09-02102-02	VRES17
CONNECTOR				
J201	CONNECTOR	2P2.54	13-12502-00	
J202	CONNECTOR	2P2.54	13-12502-00	
J203	CONNECTOR	2P2.54	13-12502-00	
P201A	CONNECTOR	8PIN	13-13908-00	
P202A	CONNECTOR	8PIN	13-13908-00	
P203B	Connector Ribbon	10P2.0-A35B	14-97310-00	PHB-2.0A-10Y
P204B	CONNECTOR	MOLEX 52807 RIGHT ANGLE/NON-ZIF/TOP CONTACT STYLE/16PIN (FPC1.0-16P)	13-21016-02	BLKCON.100/VH/TM2SQB/W.300/16

ELECTRICAL PARTS LIST

DESIGNATOR	DESCRIPTION	PART TYPE	PART NUMBER	FOOTPRINT
P205B	CONNECTOR	MOLEX 52807 RIGHT ANGLE/NON-ZIF/TOP CONTACT STYLE/16PIN (FPC1.0-16P)	13-21016-02	BLKCON.100/VH/TM2SQB/W.300/16
P206B	HOUSING	12PIN2.0-C	13-22012-00	BLKCON.100/VH/TM1SQ/W.200/12
P207A	Connector Ribbon	6P2.0-A100B 1569-26AWG	14-97506-00	PHB-2.0A-6Y
P208B	HOUSING	5PIN7.5-C	13-27505-00	BLKCON.295/VH/TM1SQ/W.600/5
P209B	HOUSING	5PIN3.96-C	13-23905-00	BLKCON.156/VH/TM1SQB/W.355/5
G2G1	Ground Solder Tap	GND-8	32-28042-00	
FUSE				
F201	FUSE	T1.6AL/250V	20-12162-01	T1.6AL/250V
F202	FUSE	T1.6AL/250V	20-12162-01	T1.6AL/250V
F203	FUSE	T1.6AL/250V	20-12162-01	T1.6AL/250V
F204	FUSE	T1.6AL/250V	20-12162-01	T1.6AL/250V
FUSE HOLDER				
F201	FUSE HOLDER	LS-PTF-78 (CQ-200C)	20-20000-06	RAD/.1000X.400/LS.850/.066
F202	FUSE HOLDER	LS-PTF-78 (CQ-200C)	20-20000-06	RAD/.1000X.400/LS.850/.066
F203	FUSE HOLDER	LS-PTF-78 (CQ-200C)	20-20000-06	RAD/.1000X.400/LS.850/.066
F204	FUSE HOLDER	LS-PTF-78 (CQ-200C)	20-20000-06	RAD/.1000X.400/LS.850/.066
JUMPER				
W201	JUMPER	10mm	21-06000-00	10mm
W202	JUMPER	10mm	21-06000-00	10mm
W203	JUMPER	20mm	21-10201-00	20mm
W204	JUMPER	25mm	21-10251-00	25mm
BUS201	BUSBAR	HS4-C270-B009V1-M006	69-006001-0	
BUS202	BUSBAR	HS4-T972-B009V1-M018	69-010004-0	
BUS203	BUSBAR	HS4-T972-B009V1-M019	69-010005-0	
BUS204	BUSBAR	HS4-T972-B009V1-M020	69-010006-0	
BUS205	BUSBAR	HS4-T972-B009V1-M021	69-010007-0	
BUS206	BUSBAR	HS4-T972-B009V1-M022	69-010008-0	
P/N 01-97303-00 PCB3 BOARD (PROTECT&SOFTCLIPPING LED)				
DIODE				
D301	LED	L-519SRSGW-CAE	33-50525-02	DYL/D.200/LS.100/.039
D302	LED	L-519SRSGW-CAE	33-50525-02	DYL/D.200/LS.100/.039
D303	LED	L-519SRSGW-CAE	33-50525-02	DYL/D.200/LS.100/.039
D304	LED	L-519SRSGW-CAE	33-50525-02	DYL/D.200/LS.100/.039
D305	LED	L-519SRSGW-CAE	33-50525-02	DYL/D.200/LS.100/.039
D306	LED	L-519SRSGW-CAE	33-50525-02	DYL/D.200/LS.100/.039
D307	LED	L-519SRSGW-CAE	33-50525-02	DYL/D.200/LS.100/.039
D308	LED	5mm, Green	33-50550-00	DYL/D.200/LS.100/.039
D309	Switch Diode	1N4148	33-44148-00	DYL/D.200/LS.100/.039
D310	Switch Diode	1N4148	33-44148-00	DAX/.300X.080/.031
D311	Switch Diode	1N4148	33-44148-00	DAX/.300X.080/.031
D312	Switch Diode	1N4148	33-44148-00	DAX/.300X.080/.031
D313	Switch Diode	1N4148	33-44148-00	DAX/.300X.080/.031
D314	Switch Diode	1N4148	33-44148-00	DAX/.300X.080/.031
D315	Switch Diode	1N4148	33-44148-00	DAX/.300X.080/.031
TRANSISTOR				
Q301	Transistor	2SA1815-GR	31-01815-00	TO92/100/ECB
Q302	Transistor	2SA1815-GR	31-01815-00	TO92/100/ECB
Q303	Transistor	2SA1815-GR	31-01815-00	TO92/100/ECB
Q304	Transistor	2SA1815-GR	31-01815-00	TO92/100/ECB
Q305	Transistor	2SA1815-GR	31-01815-00	TO92/100/ECB
Q306	Transistor	2SA1815-GR	31-01815-00	TO92/100/ECB
Q307	Transistor	2SA1815-GR	31-01815-00	TO92/100/ECB
RESISTOR				
R301	Metal Film Resistor	10K Ω , 1/6W, 5%	07-20103-00	AX/.200X.080/.031
R302	Metal Film Resistor	10K Ω , 1/6W, 5%	07-20103-00	AX/.200X.080/.031
R303	Metal Film Resistor	10K Ω , 1/6W, 5%	07-20103-00	AX/.200X.080/.031
R304	Metal Film Resistor	10K Ω , 1/6W, 5%	07-20103-00	AX/.200X.080/.031
R305	Metal Film Resistor	10K Ω , 1/6W, 5%	07-20103-00	AX/.200X.080/.031
R306	Metal Film Resistor	10K Ω , 1/6W, 5%	07-20103-00	AX/.200X.080/.031
R307	Metal Film Resistor	10K Ω , 1/6W, 5%	07-20103-00	AX/.200X.080/.031
R308	Metal Film Resistor	2K2 Ω , 1/6W, 5%	07-20222-00	AX/.200X.080/.031
R309	Metal Film Resistor	2K2 Ω , 1/6W, 5%	07-20222-00	AX/.200X.080/.031
R310	Metal Film Resistor	2K2 Ω , 1/6W, 5%	07-20222-00	AX/.200X.080/.031
R311	Metal Film Resistor	2K2 Ω , 1/6W, 5%	07-20222-00	AX/.200X.080/.031
R312	Metal Film Resistor	2K2 Ω , 1/6W, 5%	07-20222-00	AX/.200X.080/.031
R313	Metal Film Resistor	2K2 Ω , 1/6W, 5%	07-20222-00	AX/.200X.080/.031
R314	Metal Film Resistor	2K2 Ω , 1/6W, 5%	07-20222-00	AX/.200X.080/.031
R315	Metal Film Resistor	1K Ω , 1/6W, 5%	07-20102-00	AX/.200X.080/.031
R316	Metal Film Resistor	1K Ω , 1/6W, 5%	07-20102-00	AX/.200X.080/.031
R317	Metal Film Resistor	1K Ω , 1/6W, 5%	07-20102-00	AX/.200X.080/.031
R318	Metal Film Resistor	1K Ω , 1/6W, 5%	07-20102-00	AX/.200X.080/.031

ELECTRICAL PARTS LIST

DESIGNATOR	DESCRIPTION	PART TYPE	PART NUMBER	FOOTPRINT
R319	Metal Film Resistor	1K Ω , 1/6W, 5%	07-20102-00	AXI.200X.080/.031
R320	Metal Film Resistor	1K Ω , 1/6W, 5%	07-20102-00	AXI.200X.080/.031
R321	Metal Film Resistor	1K Ω , 1/6W, 5%	07-20102-00	AXI.200X.080/.031
R322	Metal Film Resistor	1K2 Ω , 1/6W, 5%	07-20122-00	AXI.200X.080/.031
R323	Metal Film Resistor	470 Ω , 1/6W, 5%	07-20471-00	AXI.200X.080/.031
CONNECTOR				
P301A	Connector Ribbon	12P2.0-A290B, 26AWG	14-97312-10	PHB-2.0A-12Y
P302	Connector Ribbon	3P2.54-A100B	14-97303-00	XHB-2.5A-3Y
P/N 01-97304-01 PCB4 BOARD (TRIGGER)				
DIODE				
D401	Zener Diode	24V, 1/2W	33-12400-00	DAXI.300X.080/.031
D402	Zener Diode	24V, 1/2W	33-12400-00	DAXI.300X.080/.031
D403	Zener Diode	24V, 1/2W	33-12400-00	DAXI.300X.080/.031
D404	Zener Diode	24V, 1/2W	33-12400-00	DAXI.300X.080/.031
RESISTOR				
R401	Metal Film Resistor	24K Ω , 1/6W, 1%	07-22402-50	AXI.200X.080/.031
R402	Metal Film Resistor	24K Ω , 1/6W, 1%	07-22402-50	AXI.200X.080/.031
R403	Metal Film Resistor	24K Ω , 1/6W, 1%	07-22402-50	AXI.200X.080/.031
R404	Metal Film Resistor	24K Ω , 1/6W, 1%	07-22402-50	AXI.200X.080/.031
R405	Metal Film Resistor	1K Ω , 1/6W, 1%	07-21001-50	AXI.200X.080/.031
R406	Metal Film Resistor	1K Ω , 1/6W, 1%	07-21001-50	AXI.200X.080/.031
R407	Metal Film Resistor	1K Ω , 1/6W, 1%	07-21001-50	AXI.200X.080/.031
R408	Metal Film Resistor	1K Ω , 1/6W, 1%	07-21001-50	AXI.200X.080/.031
R409	Metal Film Resistor	1K Ω , 1/6W, 1%	07-21001-50	AXI.200X.080/.031
R410	Metal Film Resistor	1K Ω , 1/6W, 1%	07-21001-50	AXI.200X.080/.031
R411	Metal Film Resistor	1K Ω , 1/6W, 1%	07-21001-50	AXI.200X.080/.031
R412	Metal Film Resistor	1K Ω , 1/6W, 1%	07-21001-50	AXI.200X.080/.031
R413	Metal Film Resistor	1K Ω , 1/6W, 1%	07-21001-50	AXI.200X.080/.031
CAPACITOR				
C401	ALU Electrolytic Capacitor	10uF/50V, 20%, 105 $^{\circ}$ C	06-10051-01	CPCYL1/D.200/LS.200/.031
C402	ALU Electrolytic Capacitor	10uF/50V, 20%, 105 $^{\circ}$ C	06-10051-01	CPCYL1/D.200/LS.200/.031
C403	ALU Electrolytic Capacitor	10uF/50V, 20%, 105 $^{\circ}$ C	06-10051-01	CPCYL1/D.200/LS.200/.031
C404	ALU Electrolytic Capacitor	10uF/50V, 20%, 105 $^{\circ}$ C	06-10051-01	CPCYL1/D.200/LS.200/.031
CONNECTOR				
P401B	HOUSING	12PIN2.0-C	13-22012-00	
J401	12V TRIG IN	PY301-030-100	17-07001-00	
SWITCH				
S401	SWITCH	SSSU142NA1	11-05402-00	SLIDESWITCHES/SSSU121700
S402	SWITCH	SSSU122NA1	11-05202-10	SLIDESWITCHES/SSSU141500
AH P/N : 01-97305-11 C P/N : 01-97305-21 PCB5 BOARD (STANDBY)				
DIODE				
D501	Switch Diode	1N4148	33-44148-00	DAXI.300X.080/.031
RESISTOR				
RV501	Inrush Current Limiter	0.5R030	07-70059-00	RAD1.110X.180/LS.300/.047
CAPACITOR				
C501	High Voltage Ceramic Capacitor	0.1uF, 275V, \pm 5%	05-10422-00	
JUMPER				
W501	JUMPER	7.5mm	21-06000-00	7.5mm
W502	JUMPER	10mm	21-06000-00	10mm
W503	JUMPER	15mm	21-10151-00	15mm
W504	JUMPER	15mm	21-10151-00	15mm
W505	JUMPER	7.5mm	21-10750-00	7.5mm
TRANSFORMER				
TR501	STANDBY TRANSFORMER	TD030-E102D	18-35003-00	
TR502	CURRENT TRANSFORMER	CN 10A/4mA	18-97510-00	
RELAY				
RL501	RELAYS	832A-1A-C-BH DC5V	12-03101-02	
CONNECTOR				
P501B	JACK	PCFS250L	32-26304-10	
P502B	JACK	HS4-CI9120-B009V1-M032	32-26304-00	
P503B	HOUSING	2PIN2.54-C	13-22502-00	BLKCON.100/VH/TM1SQB/W.200/2
P504B	HOUSING	2PIN3.96-C	13-23902-00	BLKCON.156/VH/TM1SQB/W.355/2
P505B	HOUSING	4PIN7.5C	13-27504-00	BLKCON.295/VH/TM1SQ/W.200/4
P506B	HOUSING	6PIN2.0-C	13-22006-00	BLKCON.080/VH/TM1SQB/W.200/6
P/N 01-97306-00 PCB6 BOARD (CONNECTION)				
JUMPER				

ELECTRICAL PARTS LIST

DESIGNATOR	DESCRIPTION	PART TYPE	PART NUMBER	FOOTPRINT
BUS601	BUSBAR	HS4-T972-B009V1-M016	69-010002-0	
BUS602	BUSBAR	HS4-T972-B009V1-M016	69-010002-0	
BUS603	BUSBAR	HS4-T972-B009V1-M016	69-010002-0	
BUS604	BUSBAR	HS4-T972-B009V1-M016	69-010002-0	
BUS605	BUSBAR	HS4-T972-B009V1-M016	69-010002-0	
BUS606	BUSBAR	HS4-T972-B009V1-M016	69-010002-0	
CONNECTOR				
P601B	Connector	MOLEX 52207 RIGHT ANGLE/SMT/ZIF/TOP CONTACT STYLE/16PIN	13-21016-01	
P602B	Connector	MOLEX 52207 RIGHT ANGLE/SMT/ZIF/TOP CONTACT STYLE/16PIN	13-21016-01	
P603B	Connector	S10B-PH-SM3-TB	13-22010-01	
P604B	Connector	MOLEX 2145/3215 TOP ENTRY/9PIN	13-25009-00	
P605B	Connector	MOLEX 2145/3215 TOP ENTRY/9PIN	13-25009-00	
P606B	Connector	MOLEX 2145/3215 TOP ENTRY/9PIN	13-25009-00	
P607B	Connector	MOLEX 2145/3215 TOP ENTRY/9PIN	13-25009-00	
P608B	Connector	MOLEX 2145/3215 TOP ENTRY/9PIN	13-25009-00	
P609B	Connector	MOLEX 2145/3215 TOP ENTRY/9PIN	13-25009-00	
P610B	Connector	MOLEX 2145/3215 TOP ENTRY/9PIN	13-25009-00	
P611B	Connector	MOLEX 2145/3215 TOP ENTRY/9PIN	13-25009-00	
P612B	Connector	MOLEX 2145/3215 TOP ENTRY/9PIN	13-25009-00	
P613B	Connector	MOLEX 2145/3215 TOP ENTRY/9PIN	13-25009-00	
P614B	Connector	MOLEX 2145/3215 TOP ENTRY/9PIN	13-25009-00	
P615B	Connector	MOLEX 2145/3215 TOP ENTRY/9PIN	13-25009-00	
P616B	Connector	MOLEX 2145/3215 TOP ENTRY/9PIN	13-25009-00	
P617B	Connector	MOLEX 2145/3215 TOP ENTRY/9PIN	13-25009-00	
P618B	Connector Ribbon	12P2.0-A580B, 26AWG	14-97312-11	PHB-2.0A-12Y
P619B	Connector	MOLEX 5145-NCH TOP ENTRY/8PIN	13-25008-00	
P620B	Connector	MOLEX 5145-NCH TOP ENTRY/8PIN	13-25008-00	
P621B	Connector	2PIN2.54	13-22502-00	
P622	Connector	2PIN2.54	13-22502-00	
P623	Connector	2PIN2.54	13-22502-00	
P/N 01-97307-00 PCB7 BOARD (POWER LED)				
DIODE				
D701	LED	L-519EGW	33-50525-00	DYL/D.200/LS.100/.039
CONNECTOR				
P701A	HOUSING	3PIN2.54C	13-22503-00	BLKCON.100/VH/TM1SQ/W.200/3
P/N 01-97308-00 PCB8 BOARD (POWER SWITCH)				
CONNECTOR				
P801A	Connector Ribbon	2P2.54-A150B 1569-26AWG	14-97302-11	XHB-2.5A-2Y
SWITCH				
S801	SWITCH	SDDL1027U-RN	11-01101-20	
P/N 01-97309-01 PCB9 BOARD (TP BOARD)				
SWITCH				
TP901	Thermal Breaker	ST-22 115C L TYPE	07-70022-11	
TP901	Thermal Breaker	ST-22 115C W TYPE	07-70022-12	
TP902	Thermal Breaker	ST-22 115C L TYPE	07-70022-11	
TP902	Thermal Breaker	ST-22 115C W TYPE	07-70022-12	
TP903	Thermal Breaker	ST-22 115C L TYPE	07-70022-11	
TP903	Thermal Breaker	ST-22 115C W TYPE	07-70022-12	
TP904	Thermal Breaker	ST-22 115C L TYPE	07-70022-11	
TP904	Thermal Breaker	ST-22 115C W TYPE	07-70022-12	
CONNECTOR				
J204	CONNECTOR	2P2.54	13-12502-02	
Assembly Parts				

ELECTRICAL PARTS LIST

DESIGNATOR	DESCRIPTION	PART TYPE	PART NUMBER	FOOTPRINT
FUSE				
	FUSE	T20AL/250V (AH)	20-11203-10	
	FUSE	T10AL/250V (C)	20-12103-20	
FUSE HOLDER				
	FUSE HOLDER	HTB-32I	20-20000-03	
AC INLET				
	AC Inlets	R-301(00)	17-07003-01	
TRANSFORMER				
	TRANSFORMER		18-97132-00	
	TRANSFORMER		18-97132-01	
CONNECTOR				
	Connector Ribbon	One terminal:KST FDFD2-187(8), another terminal: KST FDFD2-250, wire:16AWG,double-insulated,white,300V,105C 1672#, L=600mm	14-97301-00	
	Connector Ribbon	One terminal:KST FDFD2-187(5), another terminal: KST MDFN2-250, wire:16AWG,double-insulated,blue,300V,105C 1672#, L=600mm	14-97301-01	
	Connector Ribbon	One terminal:KST FDFD2-187(5), another terminal: KST FDFD2-187(8), wire:16AWG,double-insulated,blue,300V,105C 1672#, L=150mm	14-97301-02	
	Connector Ribbon	One terminal:KST FDFD2-187(8), another terminal: KST RNBL2-4, wire:16AWG Yellow&Green 300V,105C , L=150mm	14-97301-03	
FAN				
	FAN	EFB1212L	35-01212-00	
FLAT WHITE RIBBON CABLE				
P204B to P601B	Flat white ribbon cable	16PIN, 60mm, KP W9249-1A	14-97316-00	
P205B to P602B	Flat white ribbon cable	16PIN, 60mm, KP W9249-1A	14-97316-00	

EXPLODED VIEW PARTS LIST

REF.NO	PART NO.	DESCRIPTION	Qty.	REF.NO	PART NO.	DESCRIPTION	Qty.
C001	66-075002-0	Chassis	1	P009	70-010002-2	Heatsink2	4
C002	66-010006-0	Bracket1	1	P010	01-97309-01	TP Board	1
C003	01-97306-00	Connection Board	1	P011	66-018005-0	Tem. SW Clamp	4
C004	66-010008-0	Bracket3	2	P012	75-010002-0	Cushion	4
C005	01-97302-00	Power Supply Board	1	P013	75-010001-0	Capacitor Holder	1
C006	01-97305-21	Standby Board(C Version)	C:1	A001	66-010007-0	Bracket2	7
	01-97505-11	Standby Board(AH Version)	AH:1	A002	70-010001-1	Heatsink1	7
C007	01-97310-22	AMP Module(C Version)	C:7	A003	67-010002-2	Bracket4	7
	01-97310-12	AMP Module(AH Version)	AH:7	A004	78-005005-0	Insulated Cushion	28
C008	66-075003-0	Transformer Bracket	1	A005	02-03003-20	Bindding Post(C Version)	C:7
C009		Transformer Cushion	1		02-03003-10	Bindding Post(AH Version)	AH:7
C010	18-97132-00	Transformer(Toroid)	1	A006	70-019005-1	RCA	7
	18-97132-01	Transformer(Gloria)		A007	09-01502-00	Pot	7
C011	66-010004-0	Metal Disc	1	A008	73-010001-0	Rotate Knob	7
C012	94-010001-1	Transformer Lable(Toroid)	1	A009	01-97301-21	Main Board(C Version)	C:1
C013	75-010003-0	Insulated Cell	1		01-97301-11	Main Board(AH Version)	AH:1
C014	35-01212-00	Fan	3	A010	66-005009-0	TR Clamper	28
C015	65-046001-0	Pillar	12	A011	85-010001-0	Spacer Support	42
C016	79-046001-0	Cushion	24	PO01	75-005001-0	Sleeve	1
C017	79-046002-0	Shock Absorber Pad	12	PR01	75-005001-0	Sleeve	8
C018	68-010003-0	Fan Cover	3	TR01	66-010010-0	Bracket6	2
C019	75-010004-1	Foot	2	TR02	11-05202-10	Switch	1
C020	75-001008-0	Foot	2	TR03	11-05402-10	Switch	1
C021	79-008001-0	Foot Pad	4	TR04	13-22012-00	Housing	1
C022	66-010009-0	Bracket5	1	S001	61-023106-0	Self Screw STB3X6	64
F001	67-010003-0	Fascia	1	S002	61-023506-0	Machine Screw MB3X6	8
F002	67-010005-0	End Cap(R)	1	S003	61-023108-0	Self Screw STB3X8	70
F003	67-010004-0	End Cap(L)	1	S004	61-023206-0	Self Screw BTB3X6	4
F004	77-009003-1	Power Button	1	S005	61-023208-0	Self Screw BTB3X8	65
F005	77-007001-1	Power Button Bezel	1	S006	61-023508-0	Machine Screw MB3X6	4
F006	76-003001-0	Led Lens	9	S007	61-083518-0	Machine Screw MPW3X18	4
F007	66-010003-0	Subfascia	1	S008	61-024108-0	Self Screw STB4X8	10
F008	01-97303-00	Protect Softclipping Board	1	S009	61-084108-0	Self Screw STPW4X8	7
F009	01-97308-00	Power Switch Board	1	S010	61-083509-6	Self Screw MPW3.5X9	12
F010	01-97307-00	Power Led Board	1	S011	64-110110-0	Bolt M10X110	1
T001	67-010007-0	Top Cover	1	S012	63-011020-0	Washer 10 GB97.1-85	1
R001	67-010001-0	Rear Panel (C Version)	C:1	S013	63-021030-0	Spring Washer 10 GB93-87	1
	67-010006-0	Rear Panel (AH Version)	AH:1	S014	62-011002-0	Nut M10 GB6170-86	1
R002	17-07003-03	AC Inlets	1	S015	62-010302-0	Nut M3 GB6170-86	4
R003	20-20000-03	Fuse Holder	1	S016	63-020308-0	Spring Washer 3	4
R004	01-97304-01	Trigger Board	1	S017	63-010303-0	Washer 3	4
R005	71-003002-0	Grd. Post Cap	1	S018	61-023210-0	Self Screw BTB3X10	4
R006	71-010001-0	Grd. Post Bolt	1	S019	61-022205-6	Self Screw BTB2.6X5	8
P001	70-010003-0	Heatsink3	3	S020	61-013206-0	Bolt	14
P002	70-046006-0	HeatsinkC	7	S021	63-030410-0	Serrated Lock Washer	2
P003	69-010008-0	Busbar	1	S022	62-010402-0	Nut M4 GB6170-86	1
P004	69-010007-0	Busbar	1	S023	61-063108-0	STF3X8	2
P005	69-010005-0	Busbar	1	S024	61-223514-0	Machine Screw MB3X14	28
P006	69-010006-0	Busbar	1	S025	61-023215-0	Self Taping Screw BTB3X15	42
P007	69-006001-0	Busbar	1	S026	63-010408-0	washerGB/T97.1-2002,Φ4	12
P008	69-010004-0	Busbar	1				

T973 T973MKII-A T973MKII-B REPLACEMENT P/N LIST

	T973	T973MKII-A	T973MKII-B
POWER AMP AH complete	01-97510-10	01-97310-13	01-97510-10
POWER AMP C complete	01-97510-20	01-97310-23	01-97510-20
POWER SUPPLY BOARD	01-97502-99	01-97502-99	01-97502-00
DISPLAY BOARD	01-97503-99	01-97503-99	01-97503-99
TRIGGER BOARD	01-97504-00	01-97504-00	01-97504-00
STANDBY BOARD AH	01-97505-98	01-97505-98	01-97505-10
STANDBY BOARD C	01-97505-99	01-97505-99	01-97505-20
CONNECTION BOARD	01-97506-00	01-97506-00	01-97506-00
POWER LED BOARD	01-97507-99	01-97507-99	01-97507-99
POWER SWITCH BOARD	01-97508-00	01-97508-00	01-97508-00
TP BOARD	NONE	NONE	01-97509-00

T973 SERIAL NUMBER FROM H39T97300001 TO H47T97301586
T973MKII-A SERIAL NUMBER FROM H4ZT97301587 TO H5ZT97302129
T973MKII-B SERIAL NUMBER FROM H65T97302130 TO H65T97302229

Serial Number Illustrator:

First one digit (H) is the manufacturer

Second two digits (XY) are the year and month of manufacture.

Next four digits (T973) are a model code

Last five digits (XXXXX) are a series of numbers

PACKING DIAGRAM

